



FEDERAL RESERVE BANK OF NEW YORK
ECONOMIC POLICY REVIEW

SPECIAL ISSUE:
**POLICY ACTIONS IN RESPONSE
TO THE COVID-19 PANDEMIC**

Volume 28, Number 1
June 2022

SPECIAL ISSUE: POLICY ACTIONS IN RESPONSE TO THE COVID-19 PANDEMIC

CONTENTS

1 THE PRIMARY AND SECONDARY CORPORATE CREDIT FACILITIES

Nina Boyarchenko, Caren Cox, Richard K. Crump, Andrew Danzig, Anna Kovner,
Or Shachar, and Patrick Steiner

The Federal Reserve introduced the Primary Market Corporate Credit Facility (PMCCF) and the Secondary Market Corporate Credit Facility (SMCCF) in response to the severe disruptions in corporate bond markets triggered by the COVID-19 pandemic and subsequent economic shutdowns. The Corporate Credit Facilities (CCFs) were designed to work together to restore functioning of credit markets, with an overarching goal of facilitating credit provision to the nonfinancial corporate sector of the U.S. economy. This article provides an overview of the CCFs, detailing the facilities' design, documenting their operations and usage, and describing their impact on corporate bond markets.

35 THE MUNICIPAL LIQUIDITY FACILITY

Andrew Haughwout, Ben Hyman, and Or Shachar

At the onset of the COVID-19 pandemic, state and local governments were among the sectors expected to experience the most severe distress. The combination of a sharply deteriorating revenue picture, a pressing need for

additional expenditures, delays in the receipt of substantial taxes owed, and an inability to access the financial markets raised serious concerns among many observers about the ability of state and local governments to meet their public service delivery responsibilities. In April 2020, the Federal Reserve announced the establishment of the Municipal Liquidity Facility (MLF) to help municipalities manage the cash flow challenges that the pandemic produced. The MLF ultimately offered three-year loans at penalty rates to a set of eligible municipal issuers that included states, large cities and counties, and a number of revenue bond issuers. Research suggests that the MLF, in spite of lending to only the State of Illinois and the Metropolitan Transportation Authority, contributed to a healing in the municipal securities market as a whole. Effects on real economic outcomes like employment in the sector are harder to attribute to the facility.

58 THE MAIN STREET LENDING PROGRAM

David Arseneau, José Fillat, Molly Mahar, Donald P. Morgan, and Skander Van den Heuvel

The Main Street Lending Program was created to support credit to small and medium-sized businesses and nonprofit organizations that were harmed by the pandemic, particularly those that were unsupported by other pandemic-response programs. It was the most direct involvement in the business loan market by the Federal Reserve since the 1930s and 1940s. Main Street operated by buying 95 percent participations in standardized loans from lenders (mostly banks) and sharing the credit risk with them. It would end up supporting loans to more than 2,400 borrowers and co-borrowers across the United States, with an average loan size of \$9.5 million and total volume of \$17.5 billion. This article describes the facility's goals, its design, the challenges and constraints that shaped its reach, and the characteristics of its borrowers and lenders. The authors conclude with some lessons learned for future policymakers and facility designers.

93 THE FED'S CENTRAL BANK SWAP LINES AND FIMA REPO FACILITY

Mark Choi, Linda S. Goldberg, Robert Lerman, and Fabiola Ravazzolo

Building on the facility design and application experience from the global financial crisis, in March 2020 the Federal Reserve eased the terms on its standing swap lines in collaboration with other central banks,

reactivated temporary swap agreements, and introduced the new Foreign and International Monetary Authorities (FIMA) Repo Facility. While these facilities have similarities, they differ in their operations, breadth of counterparties, and range of potential effects. This article provides key details on these facilities and highlights evidence that they can reduce strains in global dollar funding markets and U.S. Treasury markets during extreme stress events.

114 THE COMMERCIAL PAPER FUNDING FACILITY

Nina Boyarchenko, Richard K. Crump, Anna Kovner, and Deborah Leonard

The Federal Reserve reestablished the Commercial Paper Funding Facility (CPFF 2020) in response to the disruptions in the commercial paper market triggered by the COVID-19 pandemic and subsequent economic shutdowns. The CPFF 2020 was designed to support market functioning and provide a liquidity backstop for the commercial paper market. This article provides an overview of the CPFF 2020, including detailing the facility's design, documenting its usage, and describing its impact on commercial paper markets. In addition, the authors compare the market conditions and facility design in CPFF 2020 to that of the original CPFF facility.

130 THE PRIMARY DEALER CREDIT FACILITY

Antoine Martin and Susan McLaughlin

The Federal Reserve established a new Primary Dealer Credit Facility (PDCF) in March 2020, to allow primary dealers to support smooth market functioning and facilitate the availability of credit to businesses and households, in the face of deteriorating conditions in the market for triparty repo financing due to the coronavirus pandemic. A similar facility had been established in March 2008 to help restore the orderly functioning of the market, following the near-bankruptcy of Bear Stearns, and to prevent the spillover of distress to other financial firms. This article provides an overview of the 2020 PDCF and compares it to the 2008 version.

139 THE MONEY MARKET MUTUAL FUND LIQUIDITY FACILITY

Kenechukwu Anadu, Marco Cipriani, Ryan M. Craver, and Gabriele La Spada

In this article, the authors discuss the run on prime money market funds (MMFs) that occurred in March 2020, at the onset of the COVID-19 pandemic, and describe the Money Market Mutual Fund Liquidity Facility (MMLF), which the Federal Reserve established in response to it. They show that the MMLF, like a similarly structured Federal Reserve facility established during the 2008 financial crisis, was an important tool in stemming investor outflows from MMFs and restoring calm in short-term funding markets. The usage of the facility was higher by funds that suffered larger outflows. After the facility's introduction, outflows from prime MMFs decreased more for those funds that had a larger share of illiquid securities. Importantly, following the introduction of the MMLF, interest rates on MMLF-ineligible securities decreased at a slower rate than those on MMLF-eligible securities, even after controlling for credit risk.

161 THE TERM ASSET-BACKED SECURITIES LOAN FACILITY

Elizabeth Caviness, Asani Sarkar, Ankur Goyal, and Woojung Park

The COVID-19 pandemic disrupted the asset-backed securities (ABS) market, resulting in higher spreads on ABS and briefly halting the issuance of some ABS. On March 23, 2020, the Federal Reserve established the Term Asset-Backed Securities Loan Facility (TALF) to support the flow of credit to consumers and businesses by re-enabling the issuance of ABS. In this article, the authors describe how TALF works, how much it was used, and its effect on the issuance and spreads of TALF-eligible securities relative to those of TALF-ineligible securities. They find that both the introduction of TALF and its subsequent expansion were associated with statistically significant declines in the spreads of TALF-eligible relative to TALF-ineligible ABS. However, the facility did not have a statistically significant effect on issuance. Finally, they compare TALF with an earlier version of the facility that was implemented during the global financial crisis and discuss lessons learned from implementing the program.

185 THE PAYCHECK PROTECTION PROGRAM LIQUIDITY FACILITY

Desi Volker

To bolster the effectiveness of the Small Business Administration’s Paycheck Protection Program (PPP), the Federal Reserve, with the backing of the Secretary of the Treasury, established the Paycheck Protection Program Liquidity Facility (PPPLF). The facility was intended to supply liquidity to financial institutions participating in the PPP and thereby provide relief to small businesses and help them maintain payroll. In this article, the author lays out the background and rationale for the creation of the facility, covers the salient features of the PPP and the PPPLF, and analyzes the facility’s loan take-up. The findings suggest that the PPPLF played an important role in expanding the supply of credit to smaller banks and nondepository institutions and that these institutions were more likely to originate PPP loans to businesses on the smaller end of the scale.

210 THE FEDERAL RESERVE’S MARKET FUNCTIONING PURCHASES

Michael J. Fleming, Haoyang Liu, Rich Podjasek, and Jake Schurmeier

This article assesses the rationale, operations, and implications of the Federal Reserve’s market functioning purchases. The security purchases were introduced in March 2020, when massive customer selling of U.S. Treasury securities and agency mortgage-backed securities triggered by the COVID-19 pandemic overwhelmed dealers’ capacity to intermediate trades, contributing to a marked deterioration of market functioning. Purchases quickly expanded to over \$100 billion per day as the Fed announced plans to buy securities “in the amounts needed” to support market functioning and the effective transmission of monetary policy. Aside from their speed and scale, the purchases were novel in that their pace and distribution depended on observable measures of market functioning. At the same time, the purchases relied on common tools, specific precedent, and general principles of a central bank’s role. After the purchases were launched, market functioning improved steadily, and the purchases were scaled back accordingly.

THE PRIMARY AND SECONDARY CORPORATE CREDIT FACILITIES

Nina Boyarchenko, Caren Cox, Richard K. Crump, Andrew Danzig, Anna Kovner, Or Shachar, and Patrick Steiner

OVERVIEW

- In March 2020, the Federal Reserve introduced the Primary Market Corporate Credit Facility (PMCCF) and the Secondary Market Corporate Credit Facility (SMCCF) to address the severe dislocations in the corporate bond market caused by the COVID-19 pandemic and associated economic shutdowns.
- The goal of the facilities, the Federal Reserve's first-ever intervention in corporate bond markets, was to support market functioning and the provision of credit to the non-financial corporate sector.
- This article describes the facilities' design, operations, usage, and impact on corporate bond markets.
- The authors show that the announcement of the program had a dramatic effect on liquidity and pricing in the secondary market while also reigniting issuance in the primary market.

The COVID-19 pandemic sparked selling across an unprecedented array of asset classes. We examine market dysfunction in the corporate bond market and measures implemented by the Federal Reserve with the support of the U.S. Treasury to ensure access to capital markets credit for U.S. corporate bond issuers.

In March 2020, the primary corporate bond markets seized up, raising concerns about access to credit for employers dependent on debt capital markets to fund their operations. As uncertainty increased about the pandemic, prices of corporate bonds, even those of investment-grade issuers, plummeted. Yield spreads relative to Treasury securities increased across the credit spectrum, with an average increase of approximately 250 basis points (bps) for investment-grade bonds and 550 bps for high-yield bonds. In the last two weeks of March 2020, mutual funds and exchange-traded funds

Nina Boyarchenko is head of Macrofinance Studies, Richard K. Crump a financial research advisor, Or Shachar a financial research economist, and Anna Kovner the director of Financial Stability Policy Research in the Federal Reserve Bank of New York's Research and Statistics Group. Caren Cox is a director and Patrick Steiner a program lead in the Bank's Supervision Group. Andrew Danzig is a policy advisor in the Bank's Markets Group. Emails: nina.boyarchenko@ny.frb.org, caren.cox@ny.frb.org, richard.crump@ny.frb.org, andrew.danzig@ny.frb.org, anna.kovner@ny.frb.org, or.shachar@ny.frb.org, patrick.steiner@ny.frb.org.

The views expressed in this article are those of the authors and do not necessarily reflect the position of the Federal Reserve Bank of New York or the Federal Reserve System. To view the authors' disclosure statements, visit https://www.newyorkfed.org/research/epr/2022/epr_2022_PMCCF-SMCCF_boyarchenko.

(ETFs) specializing in corporate bonds experienced almost \$200 billion in outflows. Measures of liquidity such as bid-ask spreads deteriorated dramatically, reaching levels not seen since the global financial crisis (GFC). These market dislocations saw a sharp increase in the pricing of investment-grade issues, with new issuance approaching interest rates at more than 50 bps above the secondary market yields of bonds of the same issuers (approximately double the usual new issue concession). High-yield corporate bond issuance halted almost entirely between March 4 and April 16, 2020. There were more than \$9.6 trillion in corporate debt securities outstanding as of the end of 2019. These corporate bonds represent the majority of U.S. corporate debt.¹

On March 23, 2020, the Board of Governors of the Federal Reserve System (the Board) announced several interventions to respond to the economic and market dislocations triggered by the pandemic and subsequent economic shutdowns.² These included the Primary Market Corporate Credit Facility (PMCCF) and the Secondary Market Corporate Credit Facility (SMCCF), together the Corporate Credit Facilities (CCFs). The CCFs were designed to work together to support market functioning for corporate bonds and syndicated loans, with an overarching goal of facilitating credit provision to the nonfinancial corporate sector of the U.S. economy. The CCFs were authorized under Section 13(3) of the Federal Reserve Act. The SMCCF commenced ETF purchases on May 12, 2020, and bond purchases on June 16, 2020. The PMCCF became operational on June 29, 2020, but no qualified borrower ever expressed the need to consummate an issuance with that facility's support. The SMCCF wound down purchases to a minimal level at the end of July 2020 and ceased purchases as of December 31, 2020, after making total purchases of \$14 billion. The Board announced the wind-down of the SMCCF portfolio on June 2, 2021, and it was completed by August 31, 2021.

The goal of the CCFs was to support market liquidity and the availability of credit for large employers by providing a backstop to U.S. issuers of investment-grade corporate debt. The CCFs worked together to reassure issuers and investors that firms would be able to roll over their maturing bonds and issue new debt, stabilizing the financial markets' ability to extend credit to U.S. businesses of good credit quality. The continued ability to issue debt enabled companies to continue to employ workers and to fund investment in working capital, investment that was increasingly required by the pandemic-related shutdowns. In addition to supporting access to capital markets, in many cases the CCFs also supported bank lending by reducing liquidity demands at banks, where many bond issuers had pre-emptively drawn down their revolving credit lines. At the extreme, even solvent corporations could be forced to default on their obligations if they could not refinance maturing debt, a catastrophe that was avoided through the restoration of bond market functioning.

This article offers an overview of the CCFs, their design, and their impact on corporate debt markets. In Section 1 we explain the role of bonds as a source of funding for U.S. corporations as well as events that led up to the dislocations in these markets and ultimately to the creation of the CCFs. Section 2 presents operational information on the PMCCF and SMCCF and explains how the facilities worked in concert to support U.S. companies. Section 3 describes the impact of the CCFs on the corporate bond market and its functioning, while Section 4 details moral hazard concerns related to official sector support of capital markets. We conclude in Section 5.

1 BACKGROUND ON CORPORATE BONDS

1.1 Overview of Corporate Bond Markets

Overall market size

The U.S. corporate bond market is one of the largest fixed income markets in the world and represents more than two-thirds of total debt funding provided to U.S. nonfinancial corporations. Chart 1 plots the time series of U.S. corporate bonds outstanding. The amount of U.S. corporate bonds outstanding has grown every year since 1980, with an average annual growth rate of 8 percent. While U.S. corporate bond issuers are large in terms of total assets, they do not all have ready access to equity financing through public markets: As of the end of 2019, firms without publicly traded equity represented more than a third of outstanding corporate bonds by amount.

The secondary market for corporate bonds has historically been over the counter, with investors interacting with dealers. Chart 2 reports the annual average daily trading volume since the advent of the Trade Reporting and Compliance Engine (TRACE). Overall trading volume has increased steadily since the GFC. Despite being a relatively smaller share of issuance, non-investment-grade issues have represented roughly a third of secondary market trading over time.

Primary market issuance and pricing

U.S. corporate debt has been growing steadily over the past twenty-four years, with investment-grade firms representing the majority of corporate bond issuance, as shown in Chart 3. More generally, when investment-grade companies work with their underwriters to issue debt in the primary market, price-setting discussions begin with reference to the traded prices of that company's own debt as well as the prices of debt of similar companies in the secondary market. The underwriters then approach potential investors to build a book of interest for that debt and settle on a market-clearing issuance price. Owing to both demand and supply factors, primary market issuance slows during periods of market distress. On the demand side, underwriters may become unwilling to intermedicate in the primary market if they are unsure of their ability to place issues, especially those from riskier borrowers during market downturns. On the supply side, since both secondary market spreads and primary-secondary spreads increase during periods of market stress, opportunistic issuance—that is, issuance by firms not facing imminent rollover financing needs due to maturing bonds—decreases. Secondary market conditions play a crucial role in the determination of the funding costs of new issuances and their quantity.

U.S. corporate bond market entering the pandemic

At the start of the pandemic, the U.S. corporate bond market had almost \$10 trillion of corporate bonds outstanding. Chart 4 plots the amount outstanding across major industry

CHART 1
U.S. Corporate Bonds Amount Outstanding

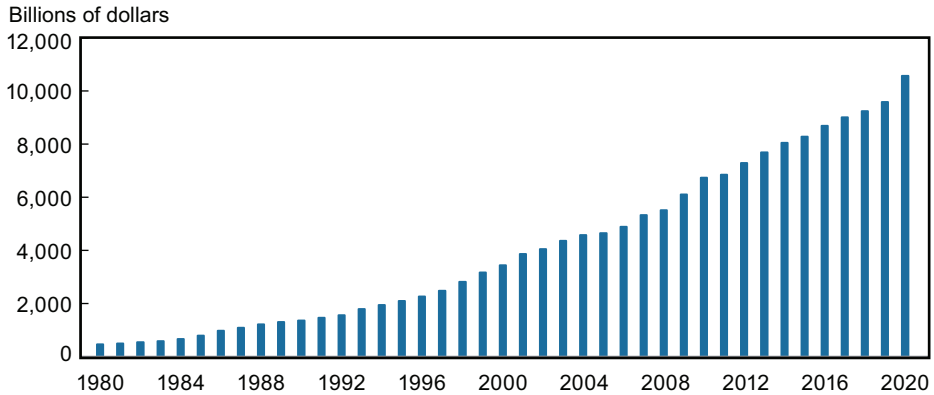

Source: SIFMA.

Notes: Amounts reflect U.S. financial and nonfinancial corporations, including bonds issued both in the United States and in foreign countries (not included are bonds issued in foreign countries by foreign subsidiaries of U.S. corporations). SIFMA considers bonds, notes, debentures, mandatory convertible securities, long-term debt, private mortgage-backed securities, and unsecured debt in its report of amount outstanding.

CHART 2
Publicly Traded U.S. Corporate Bonds Daily Trading Volume

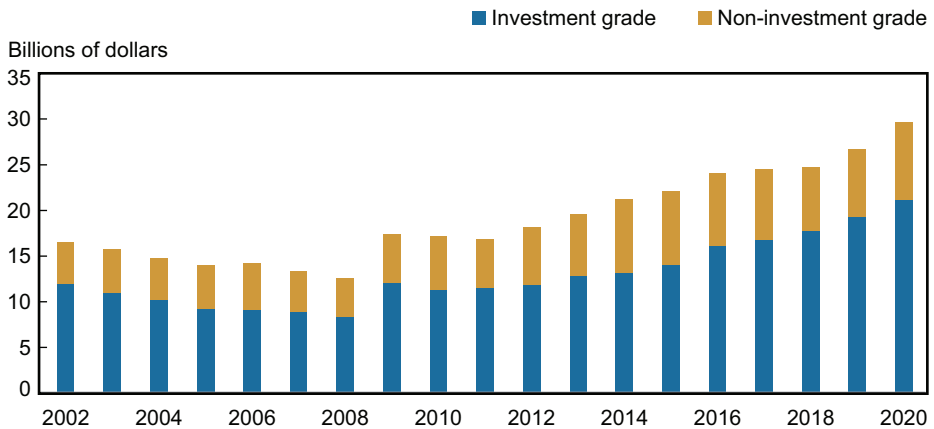

Source: SIFMA.

Note: Volume reflects U.S. financial and nonfinancial corporations, including bonds issued both in the United States and in foreign countries (not included are bonds issued in foreign countries by foreign subsidiaries of U.S. corporations).

CHART 3
U.S. Corporate Bond Issuance

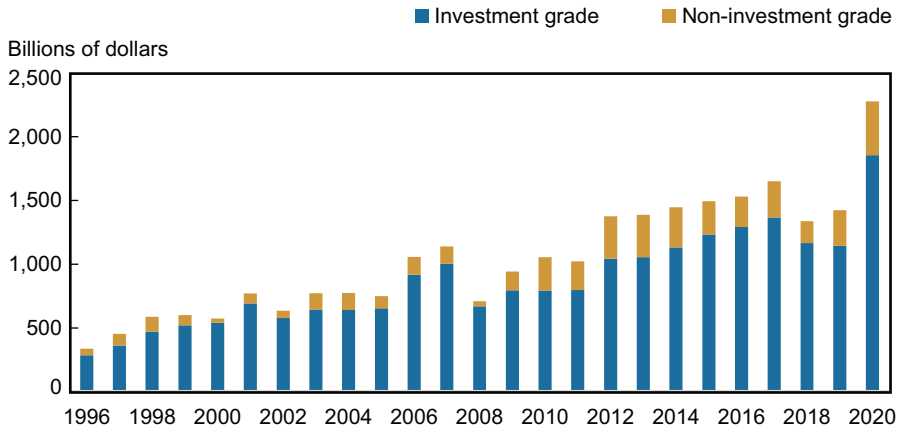

Source: SIFMA.

Notes: Reflects U.S. financial and nonfinancial corporations, including bonds issued both in the United States and in foreign countries (not included are bonds issued in foreign countries by foreign subsidiaries of U.S. corporations). SIFMA issuance includes all corporate debt, medium-term notes, and Yankee bonds, but excludes all issues with maturities of one year or less and CDs.

CHART 4
Industry Mix of Investment-Grade Corporate Bonds Amount Outstanding

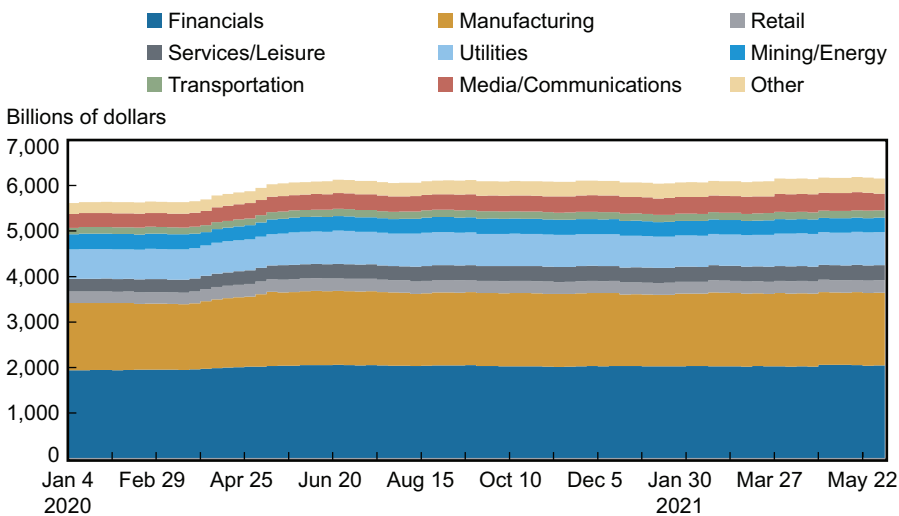

Source: Authors' calculations using Mergent FISD data.

Notes: Figures are weekly. Investment-grade is determined at the issue level based on ratings from the top three nationally recognized statistical rating organizations (NRSROs): S&P, Moody's, and Fitch. The chart shows only the universe of nonconvertible USD-denominated investment-grade bonds issued by U.S.-domiciled companies with standard bond characteristics. The sector of each bond is determined by the industry code of the issuer that is reported by Mergent FISD.

CHART 5

Rollover by Year as of December 31, 2019

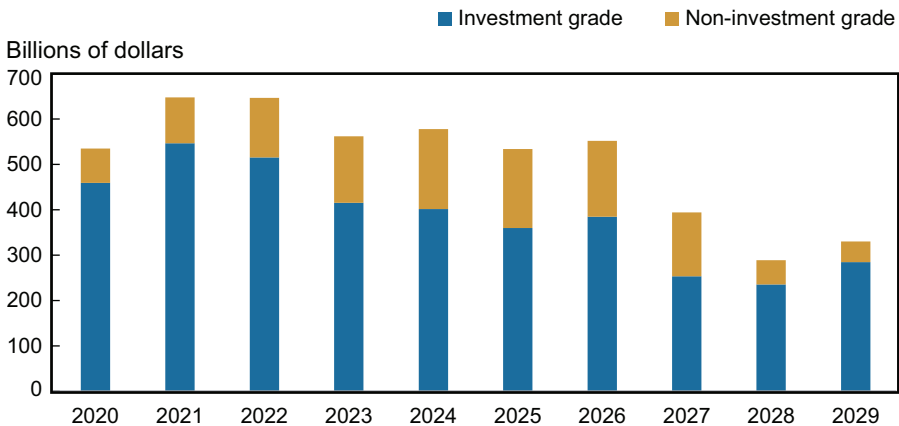

Source: Authors' calculations using Mergent FISD data.

Notes: Investment-grade and non-investment-grade are determined at the issue level based on ratings from the top three nationally recognized statistical rating organizations (NRSROs): S&P, Moody's, and Fitch. The chart shows only the universe of nonconvertible U.S. dollar-denominated investment-grade bonds issued by U.S.-domiciled companies with standard bond characteristics.

classifications. Roughly two-thirds of investment-grade amounts outstanding had been issued by nonfinancial corporations, with the manufacturing and utilities sectors the largest issuers. Thus, disruption in the corporate bond market during March 2020 had the potential to affect nonfinancial corporations significantly.³

Another way of evaluating the potential impact of the March 2020 disruption in the corporate bond market is through the lens of corporate bonds outstanding that were due to mature in the near term. Chart 5 plots the amount outstanding as of December 2019 scheduled to mature in each year from 2020 to 2029. The chart shows that a quarter of all investment-grade amounts outstanding were scheduled to mature by the end of 2021. Thus, the direct impact of a freeze in corporate bond markets—that is, the inability of issuers to roll over maturing debt—could have been very large.

To gauge the potential broader economic impact of this rollover risk, we examine the subset of U.S. corporate bond issuers with publicly traded equity and financial statement information in Compustat. We identified 358 companies with bonds that were due to mature in 2020 or 2021, representing approximately 70 percent of employees and capital expenditures of all Compustat firms. If companies were unable to refinance those bonds, their inability to repay may have led to an immediate default on all their debt obligations, through the operation of cross-default provisions in the underlying debt, in turn potentially triggering a cascade of defaults throughout their supply chain. In the extreme, firms with a total of \$2.2 trillion in public bond claims could have entered bankruptcy if cross-default provisions had been invoked. These companies employed more than 21 million people and spent more than \$1.1 trillion on capital expenditures in 2019. This does not count the employees of their suppliers, who would have been affected as well.

In addition to financing themselves in debt capital markets, many U.S. corporate bond issuers have lines of credit from banks or syndicates of banks. These lines of credit represent a significant source of funding, although generally not one large enough to refinance outstanding bonds. Significant drawdowns of credit lines were also seen at this time, as borrowers sought to ensure maximum liquidity (Acharya, Engle, and Steffen 2021).

The potential impact of bankruptcies would likely be large; estimates in the academic literature put the deadweight losses from bankruptcies at about 10 percent of company value. For example, Hortaçsu et al. (2013) find that when General Motors was at risk of defaulting during the financial crisis, the possibility of such risk reduced demand for new GM cars and the price of used GM cars. The implications of financial distress can be negative for firm value even without default: Almeida and Philippon (2007) estimate the cost of financial distress for BBB-rated issuers at 4.5 percent of firm value. While the U.S. historically has an efficient bankruptcy system to reorganize companies, the system has limited capacity, and if many companies defaulted simultaneously, reorganization would be less efficient.

Holders of corporate bonds

In addition to serving as a major source of funding for U.S. corporations, U.S. corporate bonds are also an important investment vehicle for a wide variety of investors. The majority (60 percent) of U.S. corporate bonds are owned by U.S. residents, according to data from the Treasury International Capital System. These holdings are held both indirectly, through life insurance or mutual funds, and directly, by households and pension funds, with fixed income comprising approximately 20 percent of public pension assets.

Chart 6 plots how corporate bond holdings by different types of investors have evolved over time. The chart shows that insurance companies and, in particular, life insurance companies hold an increasingly large fraction of corporate bonds outstanding. Similarly, mutual fund holdings have risen since the GFC. ETFs are a relative newcomer to the market; although their share of the market has increased noticeably over the last fifteen years, ETF holdings represent less than 4 percent of the amount outstanding. Mutual funds and ETFs engage in significant liquidity transformation, offering daily liquidity to their investors despite holding a pool of corporate bonds that may not always be readily available to trade on a daily basis. This liquidity transformation, particularly in the case of mutual funds, means that there can be a first mover advantage for fund investors, creating risks of fire sales in these markets since early sellers may receive higher prices for their shares. Thus, an additional benefit of the CCFs is that by reducing the potential for widespread defaults, the facilities may have avoided shocks to the pensions and other investments of American workers saving for retirement.

1.2 Market Dislocations in Response to COVID-19

Prior to the COVID-19 pandemic, credit spreads were at historical lows and overall market conditions were buoyant.⁴ In early March 2020, conditions started to deteriorate, with measures of liquidity and cross-market pricing indicating notable market disruption and credit spreads increasing.

CHART 6

Corporate Bond Holdings by Different Sectors of the Economy (1980-2020)

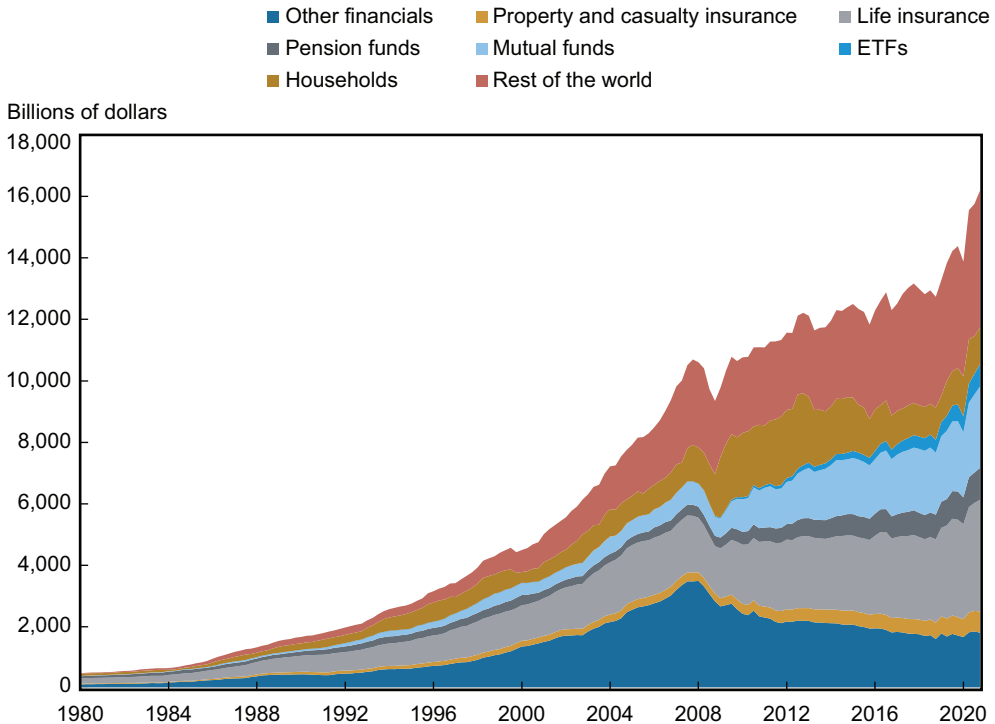

Source: Statistical Release Z.1, *Financial Accounts of the United States*, Table L.213 "Corporate and Foreign Bonds."

Note: "Households" includes hedge funds.

Chart 7 plots the evolution of average duration-matched credit spreads—that is, the spread between the priced yield on a corporate bond and the yield on an off-the-run Treasury security with a comparable cash-flow profile—for three subcategories of investment-grade bonds. Across all three categories, spreads increased precipitously at the beginning of March. Overall, between February 20 and March 21, spreads on AAA/AA increased by 200 bps, spreads on A by 240 bps, and spreads on BBB by 370 bps. These one-month increases are comparable to the worst spread changes observed during the GFC.

Bid-ask spreads, the difference between the price at which a dealer sells to and buys from a customer, are a widely used measure of liquidity because they represent the transaction cost to buy or sell a security. These spreads spiked in March to levels not seen since the GFC. Chart 8 shows that bid-ask spreads for investment-grade bonds widened rapidly at the beginning of March across all investment-grade bonds. The average bid-ask spread of investment-grade bonds increased from 15 bps in February to more than 160 bps at the March peak.

Corporate bonds are linked to other markets for credit risk, such as the credit default swap (CDS) market. The CDS-bond basis compares the price of a bond to the price of selling insurance against default from a derivative contract. Theoretically, the CDS-bond basis should be close to zero, and over the past fifteen years, the median basis has been -19 bps for investment

CHART 7
Investment-Grade Duration-Matched Credit Spreads

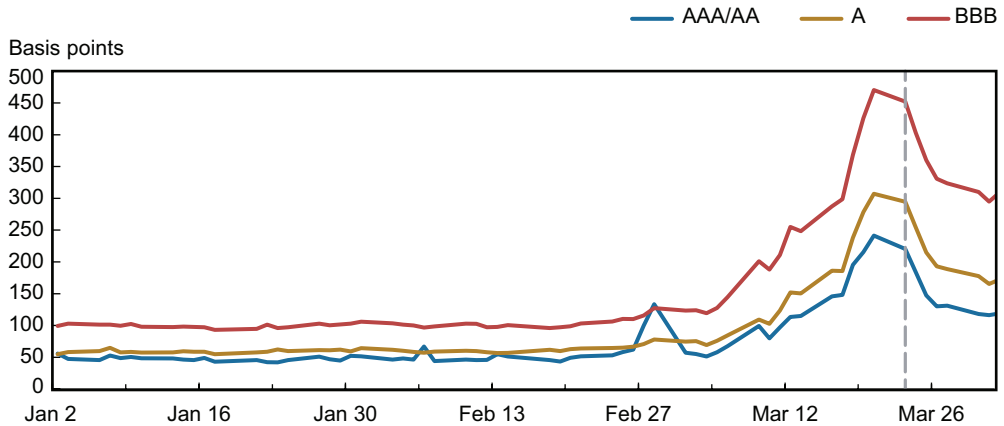

Source: Authors' calculations using dealer-to-customer transaction prices from FINRA's Trade Reporting and Compliance Engine (TRACE).

Notes: Figures are daily. "AAA/AA" includes bonds rated AAA, AA+, AA, and AA- by S&P, Moody's, or Fitch. When ratings from multiple agencies were available, the plurality rating rule was used to construct a composite bond-level rating. "A" includes bonds rated A+, A, and A-. "BBB" includes bonds rated BBB+, BBB, and BBB-. The vertical line marks the date the CCFs were announced.

CHART 8
Bid-Ask Spreads (Basis Points of Interest Rate Spreads)

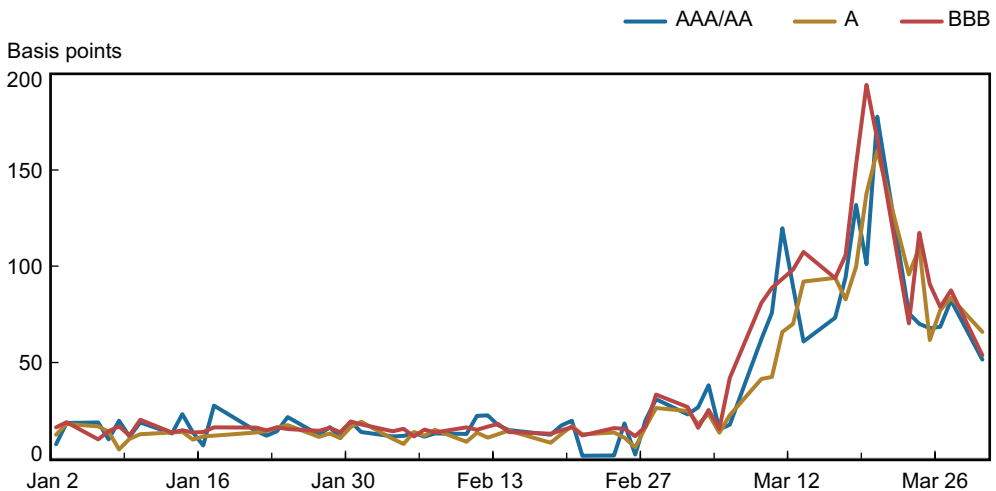

Source: Authors' calculations using dealer-to-customer transaction prices from FINRA's Trade Reporting and Compliance Engine (TRACE).

Notes: Figures are daily. "AAA/AA" includes bonds rated AAA, AA+, AA, and AA- by S&P, Moody's, or Fitch. When ratings from multiple agencies were available, the plurality rating rule was used to construct a composite bond-level rating. "A" includes bonds rated A+, A, and A-. "BBB" includes bonds rated BBB+, BBB, and BBB-.

CHART 9
CDS-Bond Basis

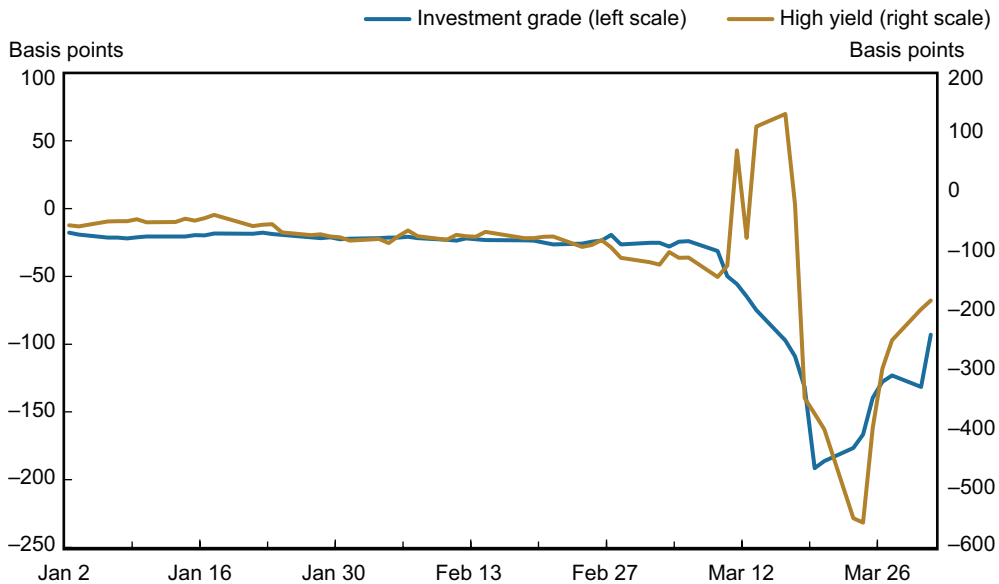

Source: JPMorgan Chase.

Notes: Figures are daily. The CDS-bond basis is the difference between the CDS spread and the implied spread on a bond with the same maturity.

grade (IG) and -42 bps for high yield (HY). A negative basis generally suggests that buying exposure to credit risk through bonds is cheaper than obtaining exposure through CDS. Periods when prices for the same financial risk are different across markets are symptomatic of poor market functioning, and Chart 9 shows that during the pandemic-related market disruptions, the basis widened substantially to reach levels of around -175 bps for IG bonds (and -550 bps for HY bonds) on March 23. For comparison, IG and HY CDS-bond bases reached -274 bps and -720 bps, respectively, during the 2007-09 financial crisis (Choi, Shachar, and Shin 2019).

Likewise, the ETF-NAV (net asset value) basis captures the difference between the traded price of an ETF and the market value of its holdings. A negative ETF-NAV basis suggests that it is cheaper to buy credit risk exposure through an ETF share than to buy the underlying basket of securities (Pan and Zeng 2019). Chart 10 shows that during the March 2020 dislocations, the average ETF-NAV basis for ETFs specializing in investment-grade bonds fell below -5 percent, indicating extreme mispricing between the more liquid ETF shares and their less liquid bond holdings. In comparison, the ETF-NAV basis for ETFs specializing in investment-grade bonds fell below -9 percent in September 2008.⁵

Generally, these breakdowns of arbitrage relations provide further evidence of market dislocation. Although it is hard to normatively conclude which market is dislocated, generally both CDS and ETF markets are considered more liquid than the corporate bond market, in particular when thinking about exposure to a basket of bonds.

CHART 10
ETF-NAV basis

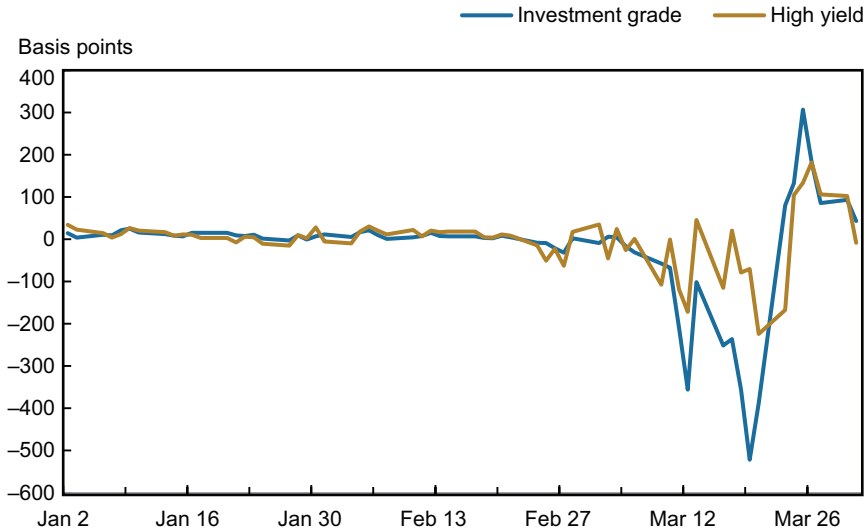

Source: Bloomberg LP.

Notes: Figures are daily. Chart shows the AUM-weighted average of the ETF-level ETF-NAV basis in each category.

2 OPERATIONAL DESIGN

2.1 CCF and Other Federal Reserve Announcements

On March 23, 2020, the Board of Governors of the Federal Reserve System announced the PMCCF and the SMCCF. The announcement included term sheets for both facilities that outlined key terms and applicability, which are described in Section 2.3.

Around the same time, the Federal Reserve announced a number of other actions, including:

- (1) purchasing Treasuries and agency securities, including residential and commercial mortgage-backed securities;
- (2) establishing the Term Asset-Backed Securities Loan Facility (TALF);
- (3) establishing the Primary Dealer Credit Facility (PDCF);
- (4) expanding the Money Market Mutual Fund Liquidity Facility (MMLF) to include a wider range of securities, including municipal variable-rate demand notes (VRDNs) and bank certificates of deposit; and
- (5) expanding the Commercial Paper Funding Facility (CPFF) to include high-quality, tax-exempt commercial paper as eligible securities and reducing the pricing of the facility.

In addition, the federal government approved approximately \$3 trillion in spending in the first half of 2020 through the Coronavirus Preparedness and Response Supplemental

Appropriations Act (March 6, 2020); the Families First Coronavirus Response Act (March 18, 2020); the Coronavirus Aid, Relief, and Economic Security (CARES) Act (March 27, 2020); and the Paycheck Protection Program and Health Care Enhancement Act (April 24, 2020). The CARES Act included approximately \$0.45 trillion in capitalization for the Federal Reserve lending facilities.

2.2 CCF Design and Operation

The PMCCF and SMCCF were designed to work together in primary and secondary markets to ensure that U.S. companies would have access to funding. The SMCCF purchased corporate bonds as well as U.S.-listed ETFs whose investment objective was to provide broad exposure to the market for U.S. corporate bonds. The purchase of ETFs was motivated by a desire to act quickly to stabilize secondary markets and thereby ensure access to credit in the primary market. As soon as was feasible, the SMCCF switched purchases to individual purchases of bonds. By providing a backstop, the facility sought to reduce the risk that corporate bonds trading in the secondary market would be susceptible to fire sales. This would allow secondary market prices to better signal a firm's fundamental cost of credit rather than the impact of market dysfunction, thus facilitating price signals for primary markets as well. In addition, seasoned bonds compete against newly issued bonds for private investors' funds; so lower secondary market yields decrease borrowing costs for businesses.

The PMCCF acted as a backstop for companies funding themselves when they sought to refinance soon-to-be-mature debt. In so doing, corporations and their investors could have confidence that the issuer would not be forced into financial distress, including bankruptcy, by a temporary disruption to capital markets. If investors and customers became uncertain about a company's ability to refinance its bonds, they might amplify distress by pulling back from the company, making it even more difficult to finance operations. He and Xiong (2012) document this concern by showing that deteriorating market liquidity exacerbates rollover risk. When debt investors require compensation for liquidity risk, a firm can be pushed into default even if it is otherwise solvent. The resultant financial distress can create a vicious cycle.

The Corporate Credit Facilities LLC (CCF LLC) was a special purpose vehicle (SPV) formed on April 13, 2020, to facilitate the PMCCF and SMCCF. The Federal Reserve Bank of New York was the CCF LLC's managing member responsible for managing the day-to-day operations of the facilities. The U.S. Treasury, as the preferred equity member, provided equity capital at inception of \$37.5 billion, which represented one-half of the U.S. Treasury's committed capital of \$75 billion.⁶ The equity capital was provided pursuant to appropriations under the CARES Act and was available to cover losses that might be realized by the CCF LLC in excess of the profits earned on the CCF LLC's holdings. The equity capital would otherwise be returned to the U.S. Treasury, along with a distribution of 90 percent of profits, once all the assets have been sold and all loans and other obligations have been paid off at the end of the CCFs. By leveraging Treasury equity 10:1 for investment-grade assets, the committed capital of the SPV could support up to \$750 billion in asset purchases fully funded with discount window loans.⁷ The initial allocation of this equity commitment was \$50 billion to the PMCCF and \$25 billion to the SMCCF.

2.3 Eligibility of Corporate Debt

Credit quality

The facilities were generally limited to credits that were investment grade as of the announcement of the CCFs. This approach is consistent with the principles of the Federal Reserve’s traditional role as lender of last resort to solvent borrowers with liquidity needs, providing credit backstops to borrowers that would generally have had no solvency concerns, but for the pandemic. Since non-investment-grade credits were generally not eligible, direct support to companies that were already highly leveraged entering the pandemic shock was limited. This had the disadvantage of reinforcing the existing cliff between investment-grade and non-investment-grade credits, but the advantage of limiting moral hazard concerns related to corporate leverage, since more levered borrowers were unable to take advantage of the CCFs directly. Eligibility status was set at the date of announcement of the CCFs, meaning that issuers that were subsequently downgraded (sometimes known as “fallen angels”), for example, were still eligible if they had been rated at least BB-/Ba3 as of the purchase date. While the inclusion of fallen angels increased the credit risk of the assets in the SPV, these issuers were eligible because of the unusual shock presented by the pandemic, where many issuers were likely to have been downgraded as a direct result of the shock.

Requiring that credits be investment grade necessitated a methodology for determining what issues met the requirement. Since the Federal Reserve does not maintain its own credit rating system, it relied on the major external nationally recognized statistical rating organizations (NRSROs), which provide ratings for corporate bond issuers.⁸ Issuer ratings were used given their close relationship to the overall financial health of the issuer rather than issue-specific features such as collateral pools, structural seniority, or unique guarantor arrangements. In the SMCCF, ratings updates were reviewed regularly to ensure ongoing eligibility. The PMCCF required updated ratings on new issues.

The SMCCF included a guideline that the preponderance of its ETF holdings had a primary investment objective of exposure to investment-grade corporate bonds, with the remainder having a primary investment objective of exposure to U.S. high-yield corporate bonds. ETFs were also monitored for credit quality to ensure that they did not include a material portion of defaulted or near-default assets.

Maturity

The expectation that the COVID-19 shock represented a short-term economic shock motivated limiting the corporate bonds that are eligible for the CCFs to those with relatively short-term maturities. Bonds acquired under the PMCCF and SMCCF were subject to maturity limitations of four years in the PMCCF and five years in the SMCCF. An added benefit of setting maturity limits for corporate bonds as an eligibility criterion is that the assets would naturally mature, allowing the Federal Reserve, should it so choose, to exit the corporate bond portfolio without having to actively sell such bonds in secondary markets. The four-year limit for the PMCCF reflects an attempt to offer maturities beyond the likely extent of the pandemic,

while the five-year limit for the SMCCF reflects the remaining time to maturity of the preponderance of outstanding bonds.

Assets held by ETFs were not subject to these same maturity limits since there was not a large enough universe of ETFs with only short maturity assets. However, the average tenor of underlying debt was a consideration in ETF selection.

U.S. domicile and industry

Limitations on SMCCF issuers and PMCCF borrowers were broadly aligned with CARES Act requirements, focused on U.S. employers, and excluded noncorporate entities and those owned by governments, both domestic and foreign. Institutions that could access CARES Act funding directly or those that borrowed through other programs such as the Main Street Lending Program were generally not eligible for the PMCCF. In addition, although debt issued by banks and bank holding companies makes up almost 30 percent of the corporate bond market, given such entities' direct or indirect access to other Federal Reserve liquidity measures, the bonds issued by such firms were not eligible for the CCFs. Since there were no existing ETFs that excluded banks or exclusively purchased bonds of U.S.-domiciled issuers, the SMCCF instead targeted ETFs that most closely matched the spirit of the mandate. However, a monthly review was conducted to determine whether holdings of bonds that were not individually eligible for the CCFs exceeded identified thresholds.

2.4 CCF LLC Credit Risk

The combination of issuer credit rating requirements, the retained profits from earnings on the CCF holdings, and the equity capital provided by the U.S. Treasury provided the requisite comfort to the Federal Reserve Bank of New York that it would be “secured to [its] satisfaction,” as required by Section 13(3) of the Federal Reserve Act. While the overall facilities contemplated a 10:1 ratio of assets to equity, lower-quality assets such as fallen angels and high-yield bonds would require greater equity, applying a ratio of 3:1 to 7:1 for fallen angel bonds, high-yield ETFs, and high-yield bonds. The leverage ratio in the CCFs was validated through analysis of credit migration and losses for bonds, as well as market risk movements for ETFs. The analysis required assumptions on: (1) worst-case default probabilities, (2) recovery rates in case of default, (3) cash flows while default does not occur, and (4) holding horizon.

One of the important aspects of modeling worst-case default probabilities is recognizing that different credit ratings experience defaults at different rates. Based on historical data from 1981-2018, AAA firms have never defaulted within one year of being rated AAA, while BBB firms have an average 0.17 percent probability of defaulting within a year.⁹ These differences in default rates are amplified at longer horizons and in periods of stress. The analysis used the rating-level worst-observed default probability term structures (using data from 1981 to 2018) to project rating-level losses. In addition, the analysis considered alternative worst-case default probability scenarios, such as a multiplicative increase in the default probability term structure,

as well as scenarios that featured credit rating slippage to account for the unprecedented nature of the pandemic shock. Recovery rates were also based on worst historical cases, using the lowest recovery rates priced in CDS auctions, and assumed that the bond portfolio would be held to maturity.¹⁰

For ETFs, the analysis required all of the above assumptions that inform the projected credit losses from the underlying bond portfolio, as well as assumptions on the market value of the ETF shares themselves. Two approaches were considered to evaluate the market value risk: one based on the overall historical worst ETF share depreciations over a fixed holding period, and the other based on a conditional projection of the bottom 5th percentile of ETF share depreciations over the same holding period.¹¹

ETFs were reviewed on a weekly basis to ensure that they did not own a material amount of defaulted or near-defaulted assets. If an ETF was found to include a significant amount of defaulted or near-defaulted assets, it was restricted from purchases until the proportion of low-quality positions was reduced. Since ETFs generally rebalance monthly, funds tended to eliminate problem assets in a short period of time.

The CCFs also limited risk through position limits. The maximum amount of outstanding bonds and loans of any issuer that would have borrowed from the PMCCF could not exceed 130 percent of such issuer's maximum outstanding bonds and loans on any day between March 22, 2019, and March 22, 2020. Additionally, the maximum amount of instruments that the PMCCF and the SMCCF combined could purchase with respect to any eligible issuer was capped at 1.5 percent of the combined potential size of the facilities (or \$11.25 billion). The maximum amount of bonds that the SMCCF could purchase in the secondary market of any eligible issuer was also capped at 10 percent of the issuer's maximum bonds outstanding on any day between March 22, 2019, and March 22, 2020, and the SMCCF could not purchase shares of an ETF in excess of 20 percent of that ETF's outstanding shares. These limits also ensured that the CCFs would not become a dominant holder of the bonds of any company, which would be a concern in a potential reorganization.

2.5 Avoiding Credit Allocation

All eligible issuers were able to access the PMCCF, meaning that credit was allocated by virtue of issuer demand and need. For the SMCCF, a broad market index of eligible issues and issuers was developed based on the outstanding universe of eligible bonds (see Section 2.6 for details). By hewing closely to an index of eligible bonds, the SMCCF ensured that it did not engage in credit allocation among different industries or issuers, since the industry mix of purchases closely reflected the industry mix of eligible issuers. In addition, the Federal Reserve's publication of the index and the tracking of holdings against it provided transparency about the SMCCF.

The downside of this approach is that it meant that no additional support was provided to issuers or industries disproportionately affected by the COVID-19 shock. Further, many corporate bond investors are buy-and-hold investors, meaning that many eligible bonds, particularly of smaller issuers, were not actively traded, making it more challenging to match the index.

2.6 SMCCF Design and Operation

Overview

The SMCCF acquired assets through purchases of (1) ETFs owning investment-grade and ETFs owning non-investment-grade corporate bonds, and (2) individual corporate bonds. Prior to the establishment of the CCFs, the Federal Reserve had not purchased corporate bonds. An investment manager (Blackrock Financial Markets Advisory) with experience in corporate bonds and ETFs was retained on an expedited basis to bring needed capabilities to the design and implementation of the CCF. Once the COVID-19 exigencies were past, some parts of the investment contract were bid out to a broader range of investment managers.¹²

In order to accelerate purchases, initial purchases were made of ETFs, which offered significant advantages in terms of speed of execution and ready access to a diversified portfolio of corporate bonds. Purchases of ETFs commenced on May 12, 2020, and continued until July 23, 2020. Once operational capacity had been developed to purchase a broad market index of individual bonds in June, bond purchases gradually replaced ETF purchases. Over time, purchases were reduced in response to improving market conditions. The purchase of individual bonds commenced on June 16, 2020, and continued until the close of the SMCCF, with the last purchases made on December 29, 2020. For the first month and a half of the facility, the average pace of daily bond purchases was around \$125 million a day, with about 40 percent of purchases concentrated in AAA/AA/A-rated bonds and about 60 percent in BBB-rated and fallen angel bonds. Once corporate credit markets stabilized, the daily pace of purchases remained constant at approximately \$20 million per day.

ETF purchases

Chart 11 shows the evolution of ETF purchases. ETFs that closed at a premium to NAV of greater than 1 percent (one standard deviation of price to NAV) were ineligible for purchase the following trading day.¹³ Intraday premiums to NAV were also checked at points during the day.

A portion of the ETFs purchased were composed of high-yield bonds, allowing for a smoothing of cliff effects at the IG/HY border and ensuring that fallen angels affected by COVID-19 were supported.

Individual bond purchases

Over the lifetime of the SMCCF, purchases totaled \$5,791 million par value, with purchases of \$2,395 million of AAA/AA/A-rated-bonds, \$3,247 million of BBB-rated bonds, and \$149 million of BB-rated (fallen angel) bonds. Bonds in the consumer noncyclical and consumer cyclical sectors constituted the largest portion of purchases—\$1,206 million and \$907 million, respectively—and bonds with maturity of three and a half to five years totaled \$2,767 million, almost 50 percent of the purchases. Chart 12 shows the evolution of bond purchases over time by rating, sector, and maturity.

CHART 11
ETF Purchases

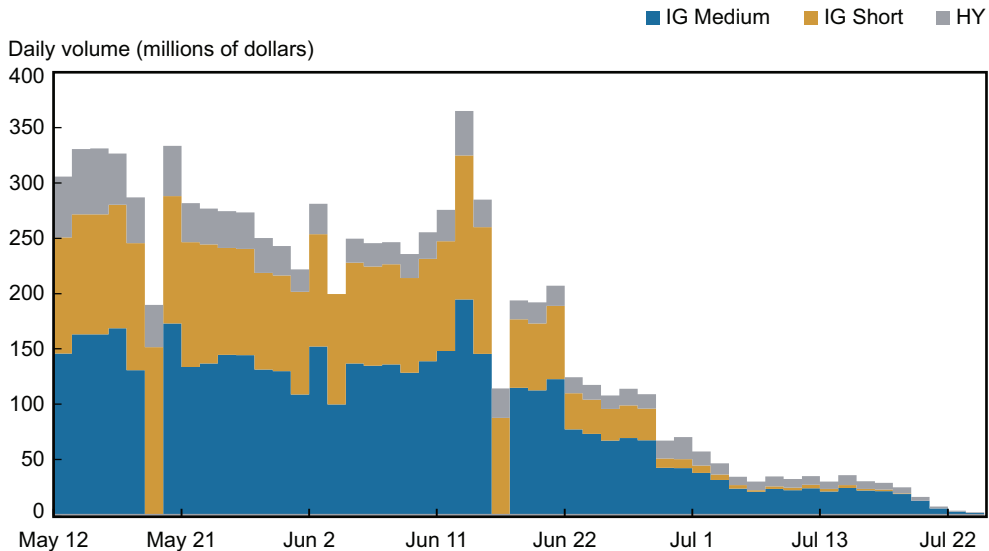

Source: Federal Reserve Bank of New York.

Notes: Figures are daily. “IG Medium” refers to medium-duration funds and includes IGIB, LQD, VCIT, and USIG; “IG Short” refers to short-duration funds and includes IGSB, SLQD, SPIB, SPSB, and VCSH; “HY” includes ANGL, HYG, HYLB, JNK, SJNK, SHYG, and USHY.

Bond purchases were targeted to track a custom index, designed to mirror the universe of eligible bonds. The Broad Market Index (BMI) was created by regularly screening and updating the universe of corporate bonds for issues meeting eligibility requirements, including maturity, rating, currency, industry, and U.S. domicile and incorporation, as well as concentration restrictions. Once an eligible amount of debt was identified for each ultimate parent, the eligible amount was allocated across bond issues on a pro rata basis to identify the amount included in the BMI. After its creation ahead of the launch of bond purchases, the BMI was updated monthly, with individual bonds assessed for eligibility weekly. BMI bonds were categorized based on liquidity: Tier 1 (most liquid), Tier 2 (less liquid but still trading), and Tier 3 (least liquid and hard to find). Purchases were targeted to align over time with sector weights within the BMI, with secondary consideration given to purchasing all Tier 1 bonds and as many Tier 2 and Tier 3 issuers as possible, and to the ratings and maturity profile of the owned portfolio. The index was published at the end of each reporting period on the New York Fed’s website at the same time that the public release of Federal Reserve Act Section 13(3) reports to Congress were published on the Board’s website.

Counterparty certification and requirements

U.S. broker-dealers that met specified requirements to become eligible sellers from whom eligible assets may be purchased served as trading counterparties for the SMCCF. To qualify as

CHART 12A
SMCCF Bond Purchases by Rating

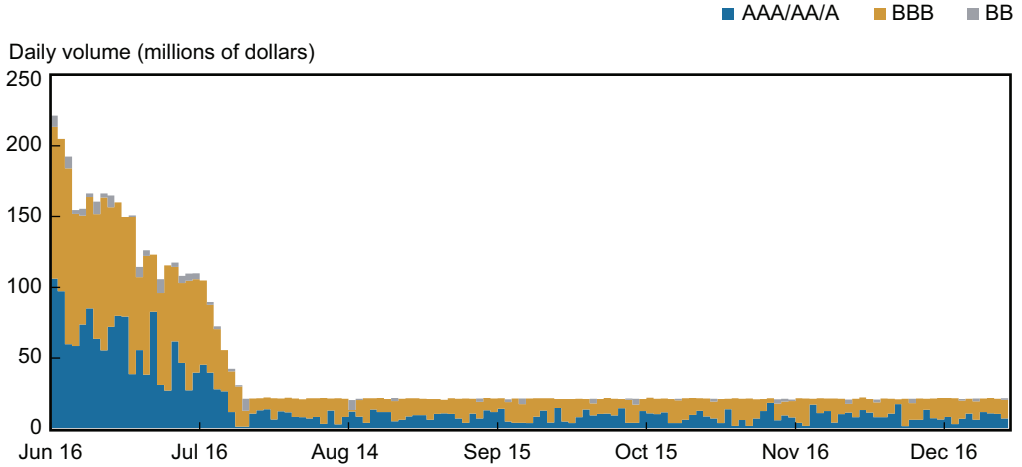
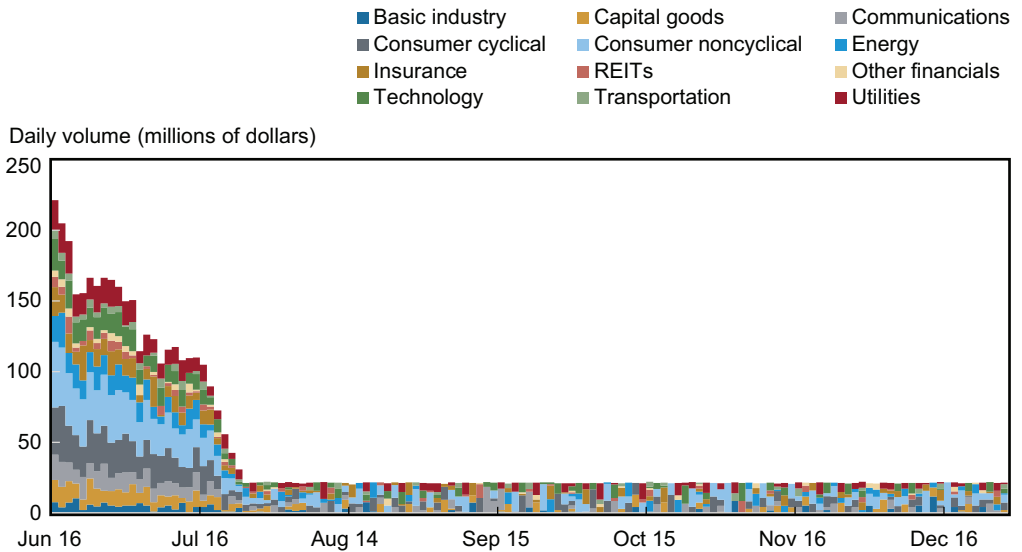

CHART 12B
SMCCF Bond Purchases by Sector



(Continued on next page)

CHART 12C

SMCCF Bond Purchases by Maturity

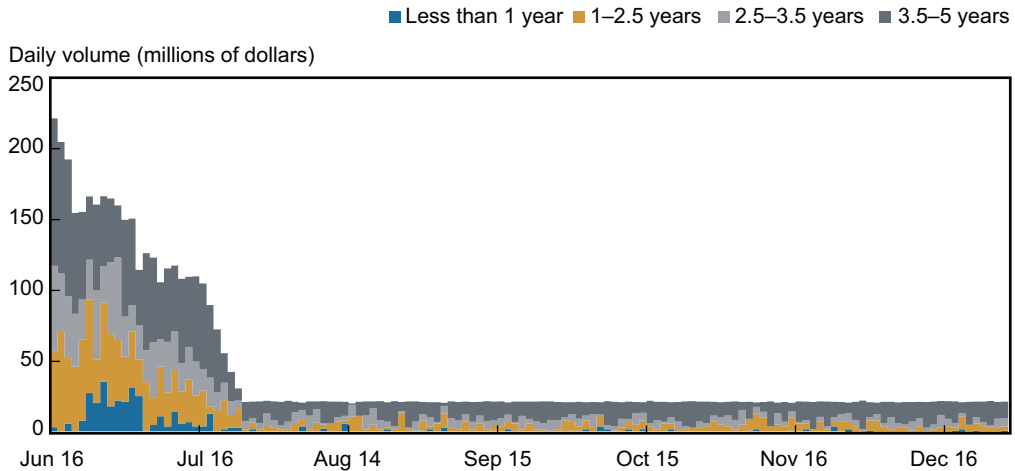

Source: Federal Reserve Bank of New York.

Notes: Figures are daily. Sectors are based on the Bloomberg Industry Classification System.

an eligible seller, a counterparty was required to, among other things, certify that it was solvent and was compliant with Sections 4003(c)(3)(C) and 4019 of the CARES Act, which required that the counterparty (1) was a business created or organized in the U.S. or under the laws of the U.S. and had significant operations in and a majority of its employees based in the U.S., and (2) satisfied the conflict-of-interest requirements in the CARES Act. The SMCCF initially identified primary dealers and affiliates of primary dealers as eligible sellers and added additional eligible sellers following due diligence, compliance, and other reviews.

Purchase pace

Generally, the purchase pace was designed to reflect market functioning concerns, with worse market functioning associated with more purchases. An index based on metrics of credit spreads, spread term structure, bid-ask spreads, and transaction costs was used along with qualitative factors to track market functioning versus a baseline measured in the twelve months prior to the crisis. In order not to disrupt typical market functioning, purchases were also based on a measure of average daily volumes. A daily score based on market functioning determined the daily purchase amount, maxing out at 30 percent of average daily trading value, with a framework that was updated over time. On July 23, 2020, the SMCCF ended ETF purchases, reflecting the fact that initial ETF purchases were based on expediency while individual bond purchases were better tailored to accomplish the program's goals. Once market functioning had improved, purchases stabilized at a very low level (\$20 million par value of individual bonds), signaling ongoing support and a willingness to provide additional support if needed.

Using a daily index to determine the daily purchase pace has some drawbacks. First, it creates a perception of the ability to precisely measure market conditions and, in particular, market dislocations at very high frequencies. As discussed above, the secondary market for corporate bonds is over the counter, with limited daily trading activity for most bonds. Daily measures of bond market pricing and liquidity are either biased if based on actual traded prices or are based on non-firm quotes. In the former case, fluctuations in the traded universe will affect measures based on which bonds trade, leading to volatility and potentially bias. In the latter case, quotes may frequently be stale and then update rapidly as transactions occur, once again leading to excess volatility.

Second, focusing on features that can be plausibly measured at a daily frequency limits the set of quantitative metrics that can be considered. For example, daily fluctuations in primary market issuance and pricing are not really meaningful, since issuance is often lumpy and issuers may not have a strict preference over issuing on any individual day. This is a particularly salient drawback from the perspective of the credit facilities, since giving issuers access to credit was a key goal.

Third, the selection of metrics was targeted initially toward capturing the particular way in which market conditions deteriorated in March 2020, rather than being representative of historical periods of dislocation more broadly. In March 2020, the term structure of corporate credit spreads inverted, with the spreads on five-year bonds below those on three-year bonds. However, it is hard to say whether past periods of dislocation featured such inversions of the credit spread curve, since past periods did not have as much trading in and issuance of shorter-maturity bonds.

An alternative approach is to use lower-frequency (weekly) metrics to construct an aggregate index of market conditions for both the primary and the secondary markets. Boyarchenko et al. (2021) propose a measure of corporate bond market distress: the Corporate Bond Market Distress Index (CMDI). The CMDI takes a “preponderance of metrics” approach, incorporating a wide range of indicators, including measures of primary market issuance and pricing, secondary market pricing and liquidity conditions, and the relative pricing between traded and nontraded bonds. The authors argue that the CMDI provides a timely indicator of corporate bond market functioning without exhibiting some of the unappealing excessive fluctuations of individual metrics.

2.7 PMCCF Design and Operation

The PMCCF’s terms allowed for the purchase of both bonds at issuance and syndicated loans. The program was launched on June 29, 2020, for bonds; loans did not become available as part of the program over the course of the 13(3) authorization period.

The PMCCF was open to all eligible issuers who applied with eligible debt. The PMCCF was not designed to seek out any issuance or debt to purchase, nor did it do so. There were two different mechanisms by which the PMCCF could participate in bond issuance, with slightly different processes, pricing terms, and criteria for each; the two mechanisms are described below. In both mechanisms, (1) the PMCCF assessed issuers a 100 basis point upfront facility fee on the face amount purchased; (2) the issuer needed to meet certain eligibility requirements, sign certain certifications to that effect, and submit relevant transaction information;

and (3) the issuer was required to sign a contingent purchase remedy side letter with the PMCCF.

Sole investor transactions

Under the first mechanism by which the PMCCF could participate in a transaction, referred to as a “sole investor” transaction, the PMCCF would purchase 100 percent of a bond issuance. For these transactions, PMCCF-specific terms needed to be incorporated into the issuer’s bond documentation, and the PMCCF determined the pricing of the new issuance. Both the PMCCF pricing methodology and the terms were nonnegotiable but were, however, intended to replicate market practices while reinforcing the backstop nature of the facility and protecting taxpayer money.

The pricing methodology for the sole investor transactions was designed to be issuer-specific and informed by market conditions. The methodology developed was rules-based, with prices based on the issuer’s own secondary market debt, adjusted for maturity. In cases where the issuer did not have secondary market debt currently outstanding, the rules-based framework would look to comparable issuers using several criteria, including, among other things, sector, similarly adjusted by tenor. The framework also included a ratings-based concession (or spread premium) to be consistent with market-based pricing where pricing concessions are typically higher for lower-rated issuers.

The pricing methodology was subject to caps and floors. These were intended to reflect the backstop nature of the facility, allowing borrowers access to funding if the market experienced extreme stress, but ensuring that the facility was not an attractive funding option when the market was closer to normal conditions. The caps and floors were set by ratings, with levels based on historical pricing of comparable U.S. issuers (three- to five-year maturity, excluding banks). For the caps, the level was set at around the 95th to 97th percentile of spreads to maturity-matched on-the-run Treasury securities, and the floors were set at or around the 50th percentile.

Sole investor transactions were required to incorporate certain terms and covenants in the issuer’s bond documentation.¹⁴ These terms, while varying slightly for investment-grade versus high-yield issuers, were intended to reflect prevailing market terms, to reinforce the backstop nature of the facility, and to offer protection for taxpayers. The terms were fixed to avoid bespoke negotiations with individual issuers.

For investment-grade issuers, terms included, among others, a negative pledge focused on principal properties, a related provision on sale-leaseback transactions, and a redemption right for a change in control that results in a downgrade below investment grade. Also, issuers were required to incorporate any more restrictive provisions of their most recently issued outstanding bonds or, if there were none, provisions of their most recent bank debt (other than financial maintenance covenants). To allow issuers to refinance in public markets, there was a market-standard make-whole call feature and an early par call (the latter available beginning three months prior to maturity).

For high-yield issuers, there were additional provisions, including limitations on indebtedness, dispositions, investments, fundamental changes, and transactions with affiliates. On

capital distributions—specifically, cash dividends and share buybacks—ordinary distributions were allowed only in line with an issuer’s past practice. Market practice, with make-whole call provisions that ratcheted down to par call over the life of the notes, was also followed.

Co-investor transactions

The second mechanism by which the PMCCF could purchase debt, referred to as a “co-investor” transaction, was designed so that the PMCCF would purchase debt at issuance alongside other investors. Co-investor transactions allowed the PMCCF to purchase debt, up to 25 percent of a new issuance, which was intended to avoid “failed” deals in case of insufficient demand. The pricing and terms for co-investor transactions were the same for the PMCCF as for the other investors in the transaction, except that a 100 basis point fee would apply to the portion of the transaction that the PMCCF purchased. For the PMCCF to purchase debt from an issuer, the issuer and issuance needed to meet the facility’s eligibility criteria.

Program-specific documentation

In order to participate in the PMCCF, issuers and their underwriters were required to submit certain program-specific documentation, including submission of authorization forms, as well as certification forms (described below).

The Advance Certification packet included certification that the issuer (1) was created or organized in the U.S. or under U.S. law, with significant operations in and a majority of its employees in the U.S. and, where relevant, would adhere to the PMCCF’s requirements regarding restrictions on the use of proceeds; and (2) satisfies the conflict-of-interest requirements of Section 4019 of the CARES Act.

The Trade Date Certification packet included certifications provided by the issuer that it (1) was not insolvent and was unable to secure adequate credit (requirements of Regulation A), and (2) has not received specific support under the CARES Act.

Last, the CCF Letter Agreement was required to be executed and delivered by the issuer (or guarantor) as a condition of closing a deal. The CCF Letter Agreement effectuated the issuer’s (or guarantor’s) obligation to repurchase the bonds sold to the PMCCF in the event that the issuer knew there was a material misrepresentation in the certifications or the confirmations in the authorization forms, or the issuer breached the use-of-proceeds restriction (if applicable). The CCF Letter Agreement also required disclosure to other investors through the indenture, and that payouts under the CCF Letter Agreement to the PMCCF were not subject to distribution with other creditors.

Exhibit 1 provides an overview of the process flow for both sole investor and co-investor transactions and issuance to the PMCCF. The process flow represents both the operational aspects of a transaction (issuance of securities, trade confirmations, and so forth) and the program-specific requirements, such as review of certification documents and oversight of the investment manager. Nearly all of the processes were applicable to both sole and co-investor transactions, with a few additional items for sole investors, as described above and shown in gold below. The investment manager additionally had

EXHIBIT 1
Issuance Process to the PMCCF

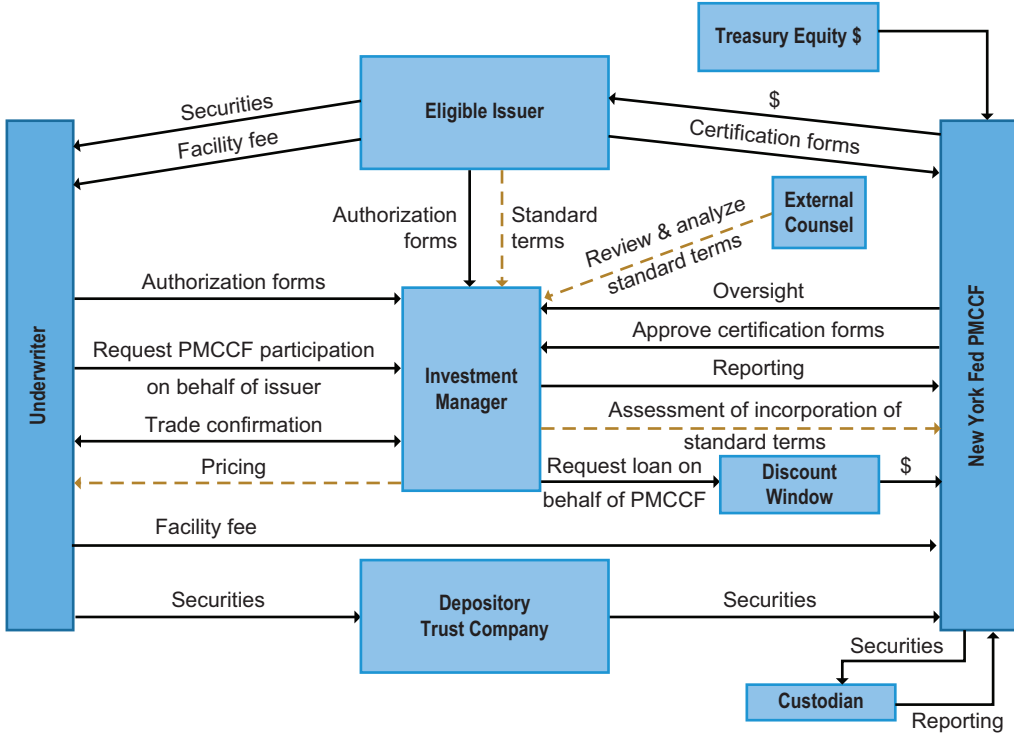

Notes: Processes along solid lines apply to both sole and co-investor transactions. Processes along dashed gold lines apply to sole investor transactions only.

responsibility for reviewing eligibility of the issuer, the issue itself, and the underwriter (these are not shown in the exhibit).

3 CCF ACTIVITY AND IMPACT ON THE CORPORATE BOND MARKET

In this section we review the impact that the CCFs had on the corporate bond market through the lens of secondary market functioning and primary market issuance activity.¹⁵

3.1 Impact of the Facilities on the Secondary Corporate Bond Market

The announcement of the program had a dramatic effect on liquidity and pricing in the secondary market while also reigniting issuance in the primary market. Chart 13 plots the time series of duration-matched credit spreads on investment-grade bonds over 2020. In the first week following announcement of the CCFs (from March 23 to March 30), credit spreads

CHART 13

Investment-Grade Duration-Matched Credit Spreads after Facilities Announcement

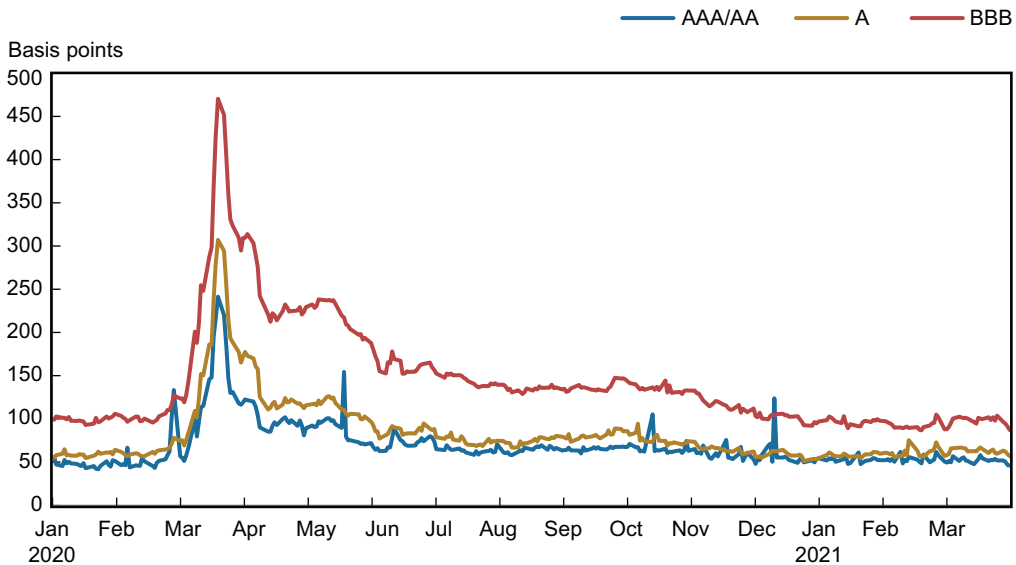

Source: Authors' calculations using dealer-to-customer transaction prices from FINRA's Trade Reporting and Compliance Engine (TRACE).

Notes: Figures are daily. "AAA/AA" includes bonds rated AAA, AA+, AA, and AA- by S&P, Moody's, or Fitch. When ratings from multiple agencies are available, the plurality rating rule is used to construct a composite bond-level rating. "A" includes bonds rated A+, A, and A-. "BBB" includes bonds rated BBB+, BBB, and BBB-.

declined by around 110 bps for bonds rated AAA, AA, and A, and by 150 bps for BBB-rated bonds. These declines were unusually sharp, representing the lowest 1 percent of one-week changes for these rating categories.

Despite these sharp declines after the initial announcement date, credit spreads returned to pre-pandemic levels sluggishly. In particular, the improvements in credit spreads lost traction in the period between April 9 and May 12, but larger declines occurred once the facility began purchases. Boyarchenko, Kovner, and Shachar (2022), using data on the Federal Reserve's purchases of both individual bonds and ETFs, show that purchases of individual bonds had a larger impact on credit spreads than purchases of ETFs, controlling for market conditions at the time of the purchases. This suggests that the pass-through from improvements in ETF market conditions to corporate bond market conditions may not be as strong. Consistent with the low levels of purchases as of the fall of 2020 and the recovery in market functioning, the announcement by the U.S. Treasury of the expiry of the CCFs at year-end and the related request for the partial return of Treasury equity on November 19, 2020, did not appear to lead to increases in credit spreads.¹⁶

Turning to secondary market liquidity, Chart 14 shows that the improvement in bid-ask spreads for investment-grade bonds was immediate following the announcement of the CCFs. Bid-ask spreads for all three rating categories declined by approximately 100 bps between March 23 and March 30. Unlike credit spreads, bid-ask spreads continued to improve past April 2020, and declined throughout the rest of 2020. Examining the effect of facility purchases

CHART 14

Investment-Grade Bid-Ask Spreads after CCFs Announcement

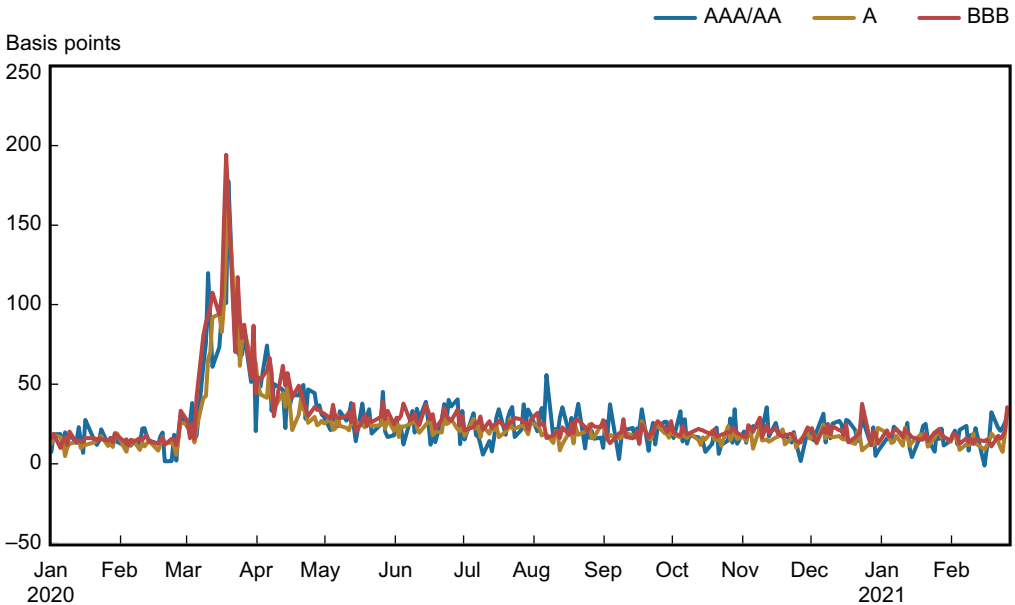

Source: Authors' calculations using dealer-to-customer transaction prices from FINRA's Trade Reporting and Compliance Engine (TRACE).

Notes: Figures are daily. "AAA/AA" includes bonds rated AAA, AA+, AA, and AA- by S&P, Moody's, or Fitch. When ratings from multiple agencies are available, the plurality rating rule is used to construct a composite bond-level rating. "A" includes bonds rated A+, A, and A-. "BBB" includes bonds rated BBB+, BBB, and BBB-.

on bond-level bid-ask spreads, Boyarchenko, Kovner, and Shachar (2022) argue that ETF purchases had limited direct effect on bid-ask spreads, suggesting that SMCCF purchases of ETFs were covered by existing ETF shares rather than the creation of new ETF shares. As with credit spreads, the facility closing announcement on November 19, 2020, did not appear to lead to a deterioration in liquidity. With credit markets continuing to heal, there were also very minimal reactions to the Federal Reserve's announcement in June 2021 of plans to sell the SMCCF holdings in a gradual and orderly manner.

Following the consistent improvement in credit market conditions and the recovery of the flow of credit to the economy, the Federal Reserve Board announced on June 2, 2021, plans to exit the SMCCF portfolio. At the time of the announcement, ETF holdings, which have no fixed maturity, accounted for over half of the SMCCF portfolio and individual corporate bonds totaled approximately \$5 billion, with maturities into 2025. The sale of ETFs started on June 7 and the sale of cash bonds started on July 12. The June 2, 2021, SMCCF wind-down announcement had little effect on credit markets and the actual sales had no adverse impact on market functioning. The lack of market reaction was likely due to the relatively small size of the SMCCF portfolio amid favorable credit market conditions. As of August 31, 2021, all of the SMCCF holdings had either matured or been sold.

CHART 15

Weekly Volume of Corporate Bond Issuance

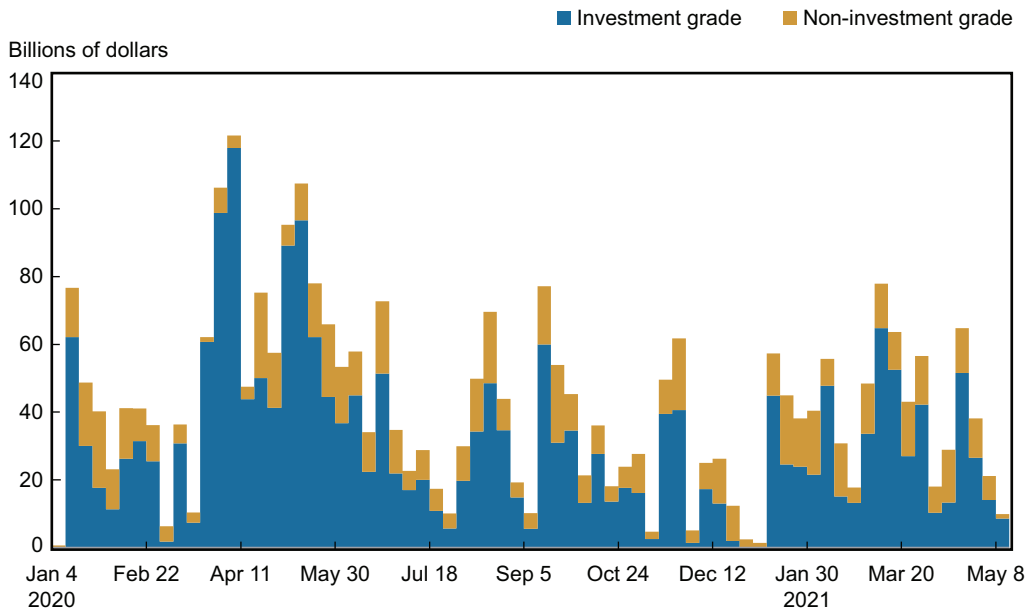

Source: Authors' calculations using Mergent FISD.

Notes: Investment-grade and non-investment-grade are determined at the issue level based on ratings from the top three nationally recognized statistical rating organizations (NRSROs): S&P, Moody's, and Fitch.

3.2 Impact of the Facilities on the Primary Corporate Bond Market

As described in Section 1, both the ability of corporations to issue corporate bonds and the interest rates on newly issued bonds are linked to secondary market conditions. We now examine how primary market activity and pricing evolved following the announcement of the CCFs.

Chart 15 plots the weekly volume of corporate bond issuances for investment-grade and non-investment-grade corporate bonds for 2020-21. Following the slowdown in issuance at the beginning of March for both rating categories, the announcement of the CCFs on March 23 triggered a revival of issuance in the investment-grade market. Non-investment-grade issuance took longer to recover, and only really accelerated following the start of facility purchases on May 12. The high levels of issuance continued throughout the rest of the year (despite the standard summer slowdown), with overall investment-grade issuance in 2020 of \$1,856 billion and non-investment-grade issuance of \$421 billion, well above previous highs.

Chart 16 shows, however, that while average primary market spreads to nearest-maturity on-the-run Treasury securities declined substantially for investment-grade bonds, improvements in primary market spreads for non-investment-grade bonds were less apparent. This may reflect the differential industry composition between investment-grade and non-investment-grade borrowers, as well as the differential investor base across the two rating categories.

CHART 16

Average Spread to Nearest-Maturity On-the-Run Treasury Securities of Newly Issued Fixed-Coupon Corporate Bonds

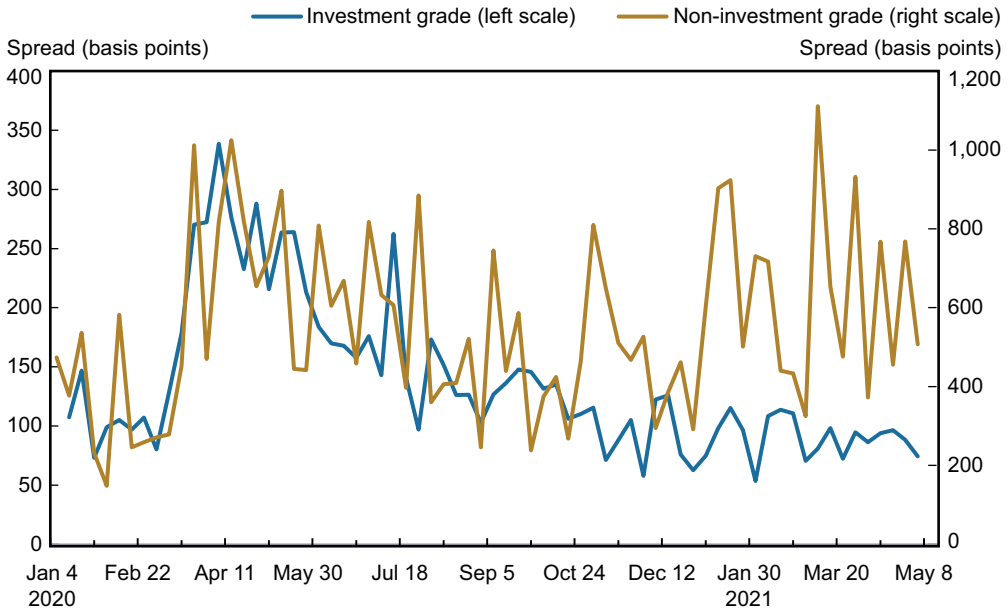

Source: Authors' calculations based on issuance spread from Mergent FISD and on-the-run Treasury yields from Bloomberg LP.

Notes: Figures are weekly. Investment-grade and non-investment-grade are determined at the issue level based on ratings from the top three nationally recognized statistical rating organizations (NRSROs): S&P, Moody's, and Fitch.

Overall, both the announcement of the facilities and the subsequent purchases appear to have substantial positive effects on market functioning, from the perspective of both secondary market trading and primary market issuance.

3.3 Facilities and Intermediation

The improvement in market functioning since the announcement of the CCFs provides evidence of the importance of the liquidity backstop, ensuring that these companies will have access to funding as long as they remain solvent. The CCFs were also intended to increase the willingness of broker-dealers to intermediate in corporate bond markets. In this case, the expectation of Federal Reserve intervention would give dealers an incentive to continue to make markets in corporate bonds. Since market making may have ceased inefficiently in March 2020, this would represent a good kind of moral hazard, helping reduce dealers' inventory risk and thereby restoring bond market liquidity.

Indeed, Boyarchenko, Kovner, and Shachar (2022) study how intermediation by FINRA-registered dealers changed over the course of the spring of 2020. They show that the

deterioration in market conditions during March was accompanied by a reduction in dealer activity in the secondary market, with non-bank-affiliated dealers reducing market making, particularly in riskier bonds. Following the facility announcement on March 23, net dealer positions in corporate bonds started to increase. However, non-bank-affiliated dealers only reentered the secondary market for non-investment-grade and longer-maturity bonds once the SMCCF began purchases on May 12. This suggests that while announcement of the CCFs served to signal their function as a liquidity backstop, actual facility purchases were required to induce intermediation in riskier bonds by dealers without access to more traditional Federal Reserve facilities. In related work, O’Hara and Zhou (2021) also argue that the Primary Dealer Credit Facility (PDCF) and the CCFs acted in concert to improve dealer funding conditions and provide a liquidity backstop to the corporate bond market. Approaching the question through the lens of customers in this market, Haddad, Moreira, and Muir (2021) suggest that the dislocations in the corporate bond, ETF, and CDS markets during March 2020 were potentially related to the liquidity needs of bond investors, again highlighting the “market maker of last resort” role of the facilities.

3.4 Implications

Given the dramatic effect of the announcement of the facility, it is natural to ask if the same results could have been achieved with a smaller facility or without the creation of the primary market facility. This is difficult to know, since the presence of liquidity often forestalls the run in the first place, meaning that the presence of the PMCCF could have bolstered investor confidence in issuers’ ability to refinance and thereby allowed the issuers to access public markets, even though the PMCCF was not accessed. Similarly, the SMCCF’s ability to purchase bonds, even if not used to its full capacity, was critical in returning the market to normal functioning.

4 MORAL HAZARD

The synchronized shock to global markets and the uncertainty related to the consequences of the pandemic and its associated shutdowns were truly exceptional circumstances, particularly the sudden and sharp realization of the shock and its economic and financial market implications. Like all 13(3) facilities, the CCFs were authorized by a vote of all Federal Reserve Governors, in response to “exigent and unusual circumstances,” and with approval from the Secretary of the Treasury. However, every official sector intervention raises concerns regarding moral hazard, and the possibility of the slippery slope of investors and firms not internalizing risk appropriately and expecting interventions that, once used, can be called on again in response to even less exigent circumstances.

In the case of the CCFs, expectations that the Federal Reserve will again act as a lender of last resort to nonfinancial corporations could lead corporate debt issuers to take on more risk than they had previously. Similar to the Commercial Paper Funding Facility (CPFF), the CCFs were designed to lessen the possibility of moral hazard through limits to eligibility and penalty

pricing of the PMCCF. While the Consolidated Appropriations Act, 2021 prohibits the restart of the CCFs as they are currently structured, it is possible that markets would nonetheless expect the CCFs to be reestablished in response to a tail shock that negatively affects corporate bond market functioning, similar to the way the CFFF was reestablished in response to the COVID-19 pandemic.

By limiting eligibility for the primary market facility to issuers that were investment grade at the time of the shock, the backstop of the facilities was available only for borrowers with relatively low credit risk. Therefore, it is hard to see how this intervention encourages leverage above levels that are consistent with investment-grade ratings. However, by taking advantage of the existing market infrastructure for credit risk evaluation and choosing to set an investment-grade eligibility bar, the facilities reinforce the investment-grade “cliff.” Specifically, while credit risk, as measured by historical default rates, is linear or exponential by credit rating, the facilities’ design reinforces the gulf in pricing between the riskiest level of investment-grade credit and the least risky below-investment-grade credit rating.

While purchasing ETFs was a novel intervention that facilitated a more expedient launch, the SMCCF’s ETF purchases present additional moral hazard concerns. Structurally, there is a mismatch between the perceived liquidity of bond ETFs and the underlying liquidity of corporate bonds. ETF liquidity relies on ETF liquidity providers, including authorized participants (mostly large broker-dealers) that can create (or redeem) ETF shares by delivering bonds in exchange for shares to the ETF sponsor (or shares in exchange for bonds). When ETF prices rise above NAV, authorized participants have an incentive to create ETF shares by acquiring a subset of an ETF’s bonds and delivering them to the sponsor in exchange for shares. As described in Section 1.2, in the bond market turmoil in 2020, bond ETF prices fell well below their NAVs and the resulting gap was not arbitrated away.¹⁷ By beginning bond market purchases through ETFs, the Federal Reserve stabilized the ETF market, and a side effect of improving corporate bond market functioning was an increase in ETF liquidity. Without such intervention, ETF investors would have incurred great losses when exiting their positions. Therefore, ETF purchases may have increased moral hazard by encouraging investors to ignore the potential for ETFs to become dramatically less liquid in the face of systemic shocks. As a result, rather than learning the true liquidity properties of ETFs, market participants may come to the wrong conclusions about future ETF liquidity in a shock—either because the data show the impact of the Federal Reserve’s intervention or because investors incorrectly assume that future bond market interventions may occur through ETFs. By developing the BMI and transitioning SMCCF purchases to direct corporate bond purchases, the Federal Reserve may mitigate moral hazard, should market participants surmise that any future interventions are less likely to require acting through ETFs. More broadly, increasing the liquidity of corporate bonds presents a moral hazard for all types of bond investors that engage in liquidity transformation.

5 CONCLUSION

The pandemic-related market disruptions were notable for the speed of the disruption and the breadth of affected markets. These widespread disruptions threatened large U.S. employers’

access to debt capital markets. This led to the establishment of the CCFs, the first ever intervention in corporate bond markets by the Federal Reserve, extending its role as a liquidity provider of last resort. In this way, the CCFs were consistent with past Federal Reserve facilities that provided liquidity to support the American market-based financial system. The legal basis for the CCFs stemmed from Section 13(3) of the Federal Reserve Act, which allows the use of such a facility only in “unusual and exigent circumstances.” The primary market facility was designed as a backstop, with penalty pricing, while the secondary market facility had a dramatic effect, supporting corporate bond markets with limited asset purchases. Its portfolio of purchased holdings peaked at \$14 billion, a tiny fraction of the market and less than 2 percent of its potential scale. Moreover, the algorithm for actual bond purchases was designed to avoid any influence on the allocation of credit across industries.

The lessons learned with regard to ensuring liquidity in debt markets can guide future policy discussions, in terms of the application for primary and secondary markets as well as the implementation that allows market support without credit allocation. The scale of the global disruption to financial markets was so unprecedented that the CCFs were a key part of a show of force by the Federal Reserve and the official sector, and one that reassured capital markets, allowing for minimal disruption of credit to large employers. As Federal Reserve Chair Powell stated, “This was really a, we hope, once-in-a-lifetime situation,”¹⁸ and these rare circumstances are unlikely to be repeated.

NOTES

Acknowledgments: The authors thank Michael Fleming, Darren Gersh, Kevin Henry, Catherine Kung, Shrilaxmi Satyanarayana, and an anonymous referee for comments and contributions. Some sections of this article are based on Boyarchenko, Kovner, and Shachar (2022) and the Liberty Street Economics posts Boyarchenko et al. (2020) and Boyarchenko, Kovner, and Shachar (2020). Dorinda Ma provided research assistance.

¹ Source: SIFMA. SIFMA “U.S. Corporate Bonds” includes debt obligations of U.S. financial and nonfinancial corporations, including bonds, notes, debentures, mandatory convertible securities, long-term debt, private mortgage-backed securities, and unsecured debt. It includes bonds issued both in the U.S. and in foreign countries, but not bonds issued in foreign countries by foreign subsidiaries of U.S. corporations.

² Other interventions by the Federal Reserve are detailed in this special issue, and key official sector announcements are described in Section 2.1.

³ For an initial view on the reasons behind the corporate credit facilities, see Boyarchenko et al. (2020).

⁴ For example, the Corporate Bond Market Dislocation Index (CMDI) was below the historical 5th percentile at the end of 2019. See Boyarchenko et al. (2021).

⁵ Comparing ETF-NAV basis dislocations in March 2020 with dislocations during the GFC is difficult, since the market for corporate bond ETFs was in its nascent stages in 2007–09, with both the number of ETFs and the assets under management (AUM) of existing ETFs much smaller than they were in 2020.

⁶ Approximately \$23.6 billion was returned to the Treasury as an interim distribution when the facilities ceased purchasing eligible assets at year-end 2020.

⁷ Purchases of non-investment-grade assets made at a lower leverage ratio reduce the notional capacity of the facilities.

⁸ Initially, three rating agencies (Moody’s Investor Service, Inc., S&P Global Ratings, and Fitch Ratings) were recognized, with a requirement that where one issuer rating was available, that rating would be used, and if two or more were available, at least two issuer ratings must be eligible. Three additional NRSROs (DBRS, Inc., Kroll Bond Rating Agency and, only with respect to insurance companies, AM Best Ratings Services, Inc.) were added as major NRSROs for the CCFs, provided that the issuer had at least one investment-grade rating from one of the three original NRSROs. Since the original approach of using two ratings was retained, the longer list of eligible NRSROs meant that the best issuer ratings, rather than the average or lowest ratings, drove eligibility. While the initial CCFs design called for ratings at the issuer level, issue-specific ratings were also considered, with individual issues made ineligible in cases where they were rated lower than the issuer, a situation that generally reflects subordination or other adverse structural features. If an issuer was not rated, as often occurs after mergers or acquisitions, the rating of an eligible U.S. affiliate was used.

⁹ See the S&P “2018 Annual Global Corporate Default and Rating Transition Study,” <https://www.spglobal.com/ratings/en/research/articles/190409-default-transition-and-recovery-2018-annual-global-corporate-default-and-rating-transition-study-10924218>.

¹⁰ Holding the bond portfolio to maturity incurs the greatest cumulative probability of losses due to default.

¹¹ The second approach recognizes that market valuations may depend on overall economic conditions. The first approach is more conservative.

¹² Cash management services were bid out; however, given that the SMCCF would be winding down its holdings, the bidding out of other investment management services was halted for expediency.

¹³ Corporate bond ETFs generally trade at a small premium to NAV.

¹⁴ If there was a guarantor of the issuer, the standard terms would apply at the guarantor level.

¹⁵ See prior analysis in Boyarchenko, Kovner, and Shachar (2022).

NOTES (CONTINUED)

¹⁶In addition, in July 2020, the Board extended the expiration date of the CCFs from September 30, 2020, to December 31, 2020. That date was not further extended.

¹⁷See Todorov (2021) for a discussion of ETF arbitrage.

¹⁸Q&A following National Association of Business Economists (NABE) speech on October 6, 2020.

REFERENCES

- Acharya, V. V., R. F. Engle III, and S. Steffen.* 2021. "Why Did Bank Stocks Crash during COVID-19?" NBER Working Paper no. w28559, March.
- Almeida, H., and T. Philippon.* 2007. "The Risk-Adjusted Cost of Financial Distress." *JOURNAL OF FINANCE* 62, no. 6 (December): 2557-86.
- Boyarchenko, N., R. Crump, A. Kovner, and O. Shachar.* 2021. "Measuring Corporate Bond Market Dislocations." Federal Reserve Bank of New York *STAFF REPORTS*, no. 957, January. https://www.newyorkfed.org/research/staff_reports/sr957.
- Boyarchenko, N., R. Crump, A. Kovner, O. Shachar, and P. Van Tassel.* 2020. "The Primary and Secondary Market Corporate Credit Facilities." Federal Reserve Bank of New York *LIBERTY STREET ECONOMICS*, May 26. <https://libertystreeteconomics.newyorkfed.org/2020/05/the-primary-and-secondary-market-corporate-credit-facilities.html>.
- Boyarchenko, N., A. Kovner, and O. Shachar.* 2020. "The Impact of the Corporate Credit Facilities." Federal Reserve Bank of New York *LIBERTY STREET ECONOMICS*, October 1. <https://libertystreeteconomics.newyorkfed.org/2020/10/the-impact-of-the-corporate-credit-facilities.html>.
- Boyarchenko, N., A. Kovner, and O. Shachar.* 2022. "It's What You Say and What You Buy: A Holistic Evaluation of the Corporate Credit Facilities." *JOURNAL OF FINANCIAL ECONOMICS* 144, no. 3 (June): 695-731.
- Choi, J., O. Shachar, and S. S. Shin.* 2019. "Dealer Liquidity Provision and the Breakdown of the Law of One Price: Evidence from the CDS–Bond Basis." *MANAGEMENT SCIENCE* 65, no. 9 (September): 4100-41.
- Haddad, V., A. Moreira, and T. Muir.* 2021. "When Selling Becomes Viral: Disruptions in Debt Markets in the COVID-19 Crisis and the Fed's Response." *REVIEW OF FINANCIAL STUDIES* 34, no. 11 (November): 5309-51. <https://academic.oup.com/rfs/article/34/11/5309/6123759>.
- He, Z., and W. Xiong.* 2012. "Rollover Risk and Credit Risk." *JOURNAL OF FINANCE* 67, no. 2 (April): 391-430.
- Hortaçsu, A., G. Matvos, C. Syverson, and S. Venkataraman.* 2013. "Indirect Costs of Financial Distress in Durable Goods Industries: The Case of Auto Manufacturers." *REVIEW OF FINANCIAL STUDIES* 26, no. 5 (May): 1248-90.
- O'Hara, M., and X. Zhou.* 2021. "Anatomy of a Liquidity Crisis: Corporate Bonds in the COVID-19 Crisis." *JOURNAL OF FINANCIAL ECONOMICS* 142, no. 1 (October): 46-68. <https://www.sciencedirect.com/science/article/pii/S0304405X21002464?via%3Dihub>.

REFERENCES (CONTINUED)

Pan, K., and Y. Zeng. 2019. "ETF Arbitrage under Liquidity Mismatch." Fourth Annual Conference on Financial Market Regulation, Jacobs Levy Equity Management Center for Quantitative Financial Research Paper.

Shleifer, A., and R. Vishny. 2011. "Fire Sales in Finance and Macroeconomics." *JOURNAL OF ECONOMIC PERSPECTIVES* 25, no. 1: 29-48.

Todorov, K. 2021. "The Anatomy of Bond ETF Arbitrage." *BIS QUARTERLY REVIEW*, March. https://www.bis.org/publ/qtrpdf/r_qt2103d.htm.

THE MUNICIPAL LIQUIDITY FACILITY

Andrew Haughwout, Ben Hyman, and Or Shachar

OVERVIEW

- The Federal Reserve’s actions in response to the COVID-19 pandemic included support for the state and local government sector via the Municipal Liquidity Facility (MLF)—a sector that contributes more than 10 percent to U.S. GDP and employs 20 million workers.
- This study reviews the creation and implementation of the facility, which offered three-year loans at penalty rates to a set of eligible municipal and revenue bond issuers.
- Analysis suggests that the MLF, in spite of limited take-up, played a significant role in improving conditions in the municipal bond market by a variety of measures. However, effects on real economic outcomes like employment in the municipal sector are harder to attribute to the facility.
- Limited eligibility and penalty pricing may have blunted the facility’s impact. The authors note that further research focused on the price elasticity of demand for short-term borrowing by municipal issuers under fiscal stress is warranted.

At the onset of the COVID-19 pandemic, state and local governments were among the sectors expected to experience the most severe distress. These governments’ dependence on revenue streams that were either rapidly declining or delayed, along with severe dislocations in municipal debt markets, created a “perfect storm” of developments that threatened their ability to function effectively when they were most needed. Many analysts predicted a state and local fiscal crisis that could be unprecedented in speed, severity, and scope.

In the spring of 2020, the Federal Reserve System, in collaboration with the U.S. Treasury, established for the first time a program under which it offered short-term funding to states, localities, and other municipal entities. In this article, we discuss the basic economics of state and local governments and the ways they use debt. We then turn to the motivation for the Municipal Liquidity Facility (MLF), as it was called, while the COVID-19 pandemic was causing severe disruptions in the municipal bond market. We provide details on how the MLF was set up, how it operated, and what is known about the effects it had on the sector and the economy.

Andrew Haughwout is the director of Household and Public Policy Research, Ben Hyman a research economist, and Or Shachar a financial research economist in the Federal Reserve Bank of New York’s Research and Statistics Group. Emails: andrew.haughwout@ny.frb.org, ben.hyman@ny.frb.org, or shachar@ny.frb.org.

The views expressed in this article are those of the authors and do not necessarily reflect the position of the Federal Reserve Bank of New York or the Federal Reserve System. To view the authors’ disclosure statements, visit https://www.newyorkfed.org/research/epr/2022/epr_2022_MLF_haughwout.

1. BACKGROUND

1.1 State and Local Government Finances

The state and local government sector is a unique but economically very important part of the U.S. economy. In calendar year 2019, the last full year prior to the pandemic, state and local government consumption and gross investment totaled \$2.3 trillion in the National Income and Product Accounts. This amount represented 10.9 percent of GDP in that year, a figure that had been above 10 percent since the mid-1960s. At the end of 2019, the sector employed nearly 20 million workers, ranging from police officers to state governors.

State and local governments, unlike the federal government, are primarily in the business of direct service provision.¹ Public safety, education, transportation, and sanitation are just a few of the services where these governments play an important role. One additional area, especially important in a pandemic, is health care. Maintaining these services in periods of economic and fiscal stress is a challenge, particularly because the sector is also unique in its financing. State and local governments are generally required by their constitutions or by statute to balance their operating budgets—in other words, they are not allowed to spend more than they collect in revenue. These balanced budget requirements (BBRs) are intended to help control spending and reduce intertemporal burden shifting. Therefore, state and local governments primarily issue long-term debt in order to finance long-lived infrastructure investments like bridges, sewers, and schools. Thus, while there is a very large market in long-term municipal bonds, those bonds are usually sold to finance capital projects and not to spread the costs of economic downturns or fiscal stress.²

BBRs, however, can have some unintended effects in aggregate. In particular, they tend to induce some pro-cyclicality in the behavior of the sector as a whole. Generally speaking, as the economy contracts, state and local government tax bases decline as well, leading to pressure for reductions in (expected or realized) tax and fee revenues. BBRs force public officials to make difficult choices to increase tax rates—further reducing private disposable income—or to cut spending. In addition to the human toll caused by reduced incomes and/or employment, and the likely deterioration in the core public services produced by the sector, these actions put further downward pressure on economic activity, just as the economy is weakening.

The structure of state and local government budget processes does tend to build some lags into these responses: Subnational governments' fiscal years typically begin in July and end in June, and unanticipated changes in the economy after budgets are adopted may not produce immediate changes in spending or taxes. In addition, much of the sector's revenue (and direct spending) is at the local level, where dependence on property taxes is high. Since assessed property values are less strongly correlated with overall activity than sales and income are—sales and income being states' primary tax bases—local budgetary pressures tend to lag even further, becoming apparent when assessed property values fall and/or when state aid (a crucial part of local budgets) is cut.

These features of the sector were apparent in the 2007-09 recession. In the roughly two years between the second quarter of 2005 and the third quarter of 2007, state and local government activity contributed an average of +7 basis points to aggregate GDP growth. The economy was expanding for most of this period, and state and local governments were contributing positively to that growth, albeit slightly. In the early stages of the recession that began

CHART 1

State and Local Government Employment

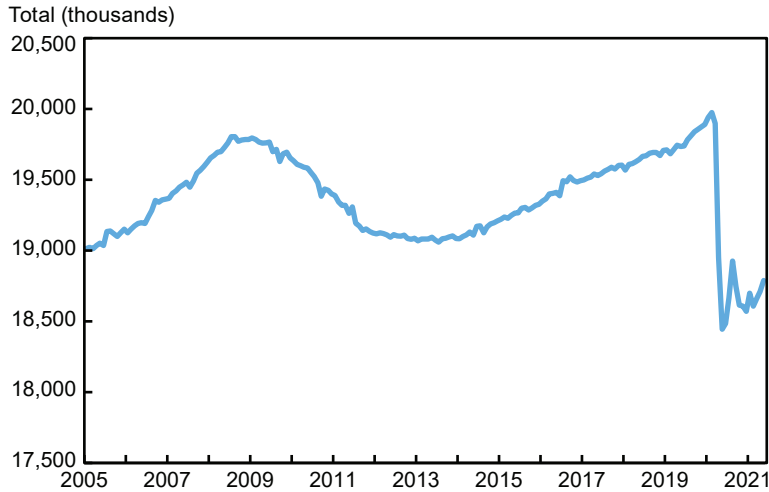

Source: U.S. Bureau of Labor Statistics.

in late 2007, the sector's growth contributions actually increased—state and local government activity averaged a contribution of +20 basis points as the economy experienced its first four quarters of recession. But by late 2008, the sector's growth contribution turned sharply negative, and its annual contribution remained negative through 2013. Employment in the sector, shown in Chart 1, fell sharply beginning in the middle of the recession, and did not recover to its pre-recession level until the end of 2015. The sector's slow rebound, then, was part of the explanation for the slow national recovery from the Great Recession, making the sector's resiliency an area of concern for future macroeconomic policy.³

1.2 Municipal Debt

There are two important qualifications to the important role that BBRs play in the state and local sector. We have already briefly discussed the first: the issuance of long-term municipal bonds as a mean of financing long-lived infrastructure investments like public buildings, roads, and water systems. The second is the ability of many municipalities to use short-term notes to smooth cash flows within a fiscal year. In this section, we will provide an overview of these markets, as they are important for understanding the purposes and limitations of the MLF.

Bonds

The \$3.8 trillion municipal bond market contains more than 50,000 issuers and one million individual bonds, making it approximately half the size of the corporate bond market with ten times as many issuers. Roughly 90 percent of this market is exempt from federal income tax, and more

CHART 2
Municipal Bond Holders, 2004–20

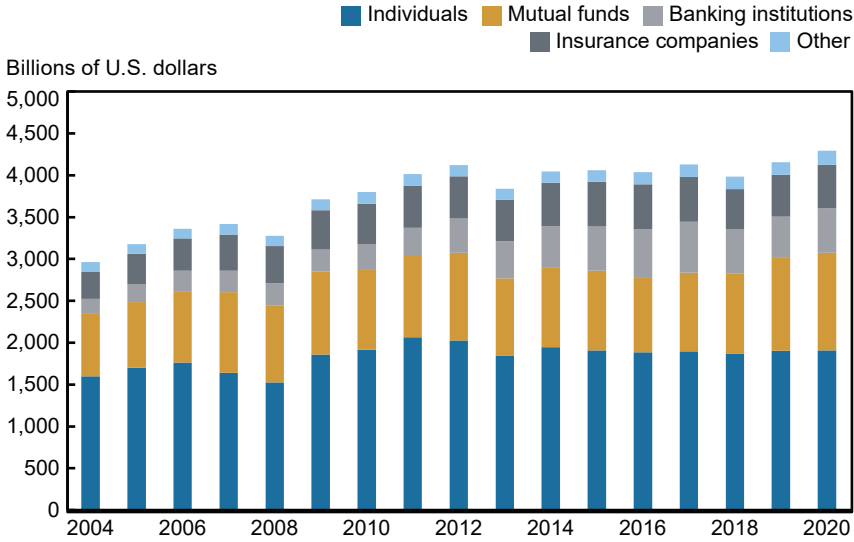

Source: Board of Governors of the Federal Reserve System.

Notes: The category for Individuals includes households and nonprofit organizations. Mutual funds includes mutual funds, money market funds, closed-end funds, and exchange-traded funds. Banking institutions includes U.S.-chartered depository institutions, foreign banking offices in the United States, banks in U.S.-affiliated areas, credit unions, and broker-dealers. Insurance companies includes property-casualty and life insurance companies. Other includes nonfinancial corporate business, nonfinancial noncorporate business, state and local governments and retirement funds, government-sponsored enterprises, and municipal securities held by the COVID-19 Municipal Liquidity Facility and foreign holders. The discrepancy is the accumulated valuation difference between issuance and holdings.

than 80 percent is rated investment grade. Consequently, default rates on rated municipal bonds have historically been very low, although unrated bonds have defaulted more frequently (Appleson et al. 2012; Moody’s 2020). As of May 2020, 26 percent of outstanding debt was issued directly by state, city, county, and other local governments, 41 percent by utilities, service, and transit issuers, 21 percent by school districts, and 8 percent by public hospitals. Unlike Treasury and corporate bond markets, 70 percent of municipal debt is held by retail investors seeking tax advantages associated with municipal bond returns, with a third of that total in mutual funds and exchange-traded funds (see Chart 2). Unlike the corporate sector, municipal debt is also commonly issued in deals containing many different tenors as independent bonds, facilitating more predictable budget smoothing but complicating the analysis of the market.

General obligation (GO) bonds, which constitute approximately 30 percent of the long-term municipal market, are not secured by a specific revenue source but are instead backed by the “full faith and credit” of the taxing authority and typically finance capital projects like bridges and schools. The large remainder of the long-term market (60 percent) is dominated by revenue bonds (RB), frequently issued by public enterprises and secured by defined revenue sources (such as transit user fees, airport revenues, and road and bridge tolls).

Notes

Less well known but quite important in general and specifically in the pandemic, state and local governments also frequently leverage the \$440 billion short-term municipal note market to bridge cash flow gaps *within* fiscal years. This short-term borrowing can be useful because states and localities depend on revenues (tax receipts, federal grants, the proceeds of bond issues, and other revenues) that are received at specific intervals during the fiscal year. But the timing of spending needs—for example, for payroll—may not be well-matched with the arrival of receipts, creating a need for a way to smooth spending in anticipation of such receipts. These governmental entities can do so by issuing tax anticipation notes (TANs), revenue anticipation notes (RANs), tax and revenue anticipation notes (TRANs), and bond anticipation notes (BANs). These notes are typically secured by funds expected to be received later in the fiscal year and are paid off when the relevant funding is received. Note that issuers typically seek funding at the same time each year, and market access is critical to maintaining liquidity.

A classic example of a mismatch between the timing of receipts and expenditure needs is the proceeds from final settlement of state income tax returns. In most states that levy an income tax, these settlements are due on the federal government's tax day, typically April 15. For states like New Jersey, these final settlements are often substantial (New Jerseyans in aggregate owe a substantial amount of tax on unearned income and capital gains) and many of these proceeds are received right around the end of the state's fiscal year, which closes June 30. The value of these settlements is based on activity that occurred in the previous calendar year, so it is known with a relatively high degree of confidence. Therefore, New Jersey could issue a TAN in January, with a maturity of April 30, to enable it to spend part of the expected settlement amount in the interim.

It is important to note that the primary market interest rates at which governments issue new debt in the municipal market are strongly linked to secondary market yields. This is because primary market pricing is usually benchmarked to secondary market prices of similar bonds, and the willingness of dealers to underwrite bonds is affected by market conditions (Boyarchenko et al. 2020). Price discovery occurs through submissions to exchanges, and is exceptionally low in this market in part due to the low volume of transacted trades (Green et al. 2010). In an average expansion year (such as 2019), there are 6,500 trades a day, with a median trade size of about \$30,000, far less frequent and at lower volumes than corporate bonds (Haughwout, Hyman, and Shachar 2021).

2. STATE AND LOCAL BUDGETS IN THE ERA OF COVID-19

As the cataclysmic economic consequences of the pandemic began to become evident in the United States during spring and summer of 2020, several concerns directly related to states and municipalities came to the fore. First, many analysts predicted dire consequences for the revenues of state and local governments. Disruptions to economic activity threatened virtually all forms of the sector's revenues. One analysis (Fiedler and Powell 2020), using data from previous downturns, suggested that each year-over-year percentage point increase in the unemployment rate had historically been associated with a \$45 billion deterioration in the fiscal situation of state and local governments, the vast majority of which consists of revenue declines associated with reduced

economic activity. In April 2020, the unemployment rate stood at 14.7 percent, a stunning 11.1 percentage points higher than its level a year earlier (and 11.2 percentage points above its level of two months earlier, in February 2020). This change suggested an annual fiscal shock of around \$500 billion to the sector. Fiedler and Powell (2020) describe several sources of uncertainty in this estimate, including reasons to have expected the shock to be larger (for example, noting that business closures may mean that the sales tax elasticity to unemployment turns out to be larger than usual) or smaller (observing that the increase in unemployment was unusually concentrated among low-wage workers, thereby reducing the income tax elasticity to below-normal levels). By mid-summer, it was becoming clear that at least some of the sharp increase in unemployment was transitory. By July, the rate stood at 10.2 percent, still far above its year-ago level, but already down 450 basis points from its April peak. Estimates from this period suggested state fiscal impacts in the neighborhood of \$75-\$100 billion for fiscal year 2020, and \$100-\$300 billion for 2021 (Dadayan 2020; McNichol and Leachman 2020; Auerbach et al. 2020 estimated a fiscal year 2021 effect of \$167 billion for state and local governments combined).⁴

In addition to the employment rebound, several factors contributed to this improvement in the outlook for states. Employment losses were concentrated in relatively low-wage jobs, and incomes of the unemployed were supported by supplemental unemployment compensation payments, which are typically taxable incomes for states. Both of these factors moderated the income tax revenue effect of the downturn relative to what might have been expected. In addition, while consumption fell dramatically in the pandemic's early days, the largest declines were in services, while more heavily taxed goods consumption was less affected, helping to stabilize sales tax revenues.⁵ A final bright spot in the outlook was property taxes, which are the primary source of own-source local government revenue and which, buoyed by high home price growth, remained strong into 2021.⁶ Nonetheless, the state and local sector as a whole had shed more than 1.3 million jobs very early into the pandemic, primarily in local education, and concerns for state and local governments remained heightened through much of 2020.⁷ The fact that so many jobs were lost in local education just as schools were closing for public health reasons, along with the slow subsequent recovery in the sector in spite of a brightening fiscal picture, suggest that a shortage of revenues—or even the expectation of a revenue decline in the near future—was not the key concern. Rather a lack of demand for bus drivers, cafeteria workers, and school maintenance staff in a “learn from home” environment may explain the employment losses in spring 2020.

A second major concern was with the need for states, and especially localities, to increase spending to mitigate the effects of the COVID-19 pandemic. A survey conducted by the National Association of Counties found that if the pandemic were to last a year, more than 1,100 counties expected to spend at least 10 percent of their budgets on fighting the virus, and in aggregate counties expected nearly \$30 billion in additional spending, largely for support of county hospitals and local health agencies.⁸

A third area of concern was that the policy decision to move the federal income tax filing deadline from April 15 to July 15 might create a need for new sources of liquidity for many states. The change in the filing deadline created a substantial budget shortfall for the many states that depend on income taxes, but it was one that seemed almost certain to be largely made up in July 2020, given that the receipts that were due with final settlements were based on activity that took place in 2019 and so would be virtually unaffected by the pandemic.⁹ As a consequence, many observers expected a spike in the demand for short-term financing—TANs—to fund the

CHART 3

Monthly Municipal Bond Issuance, January 2019–May 2021

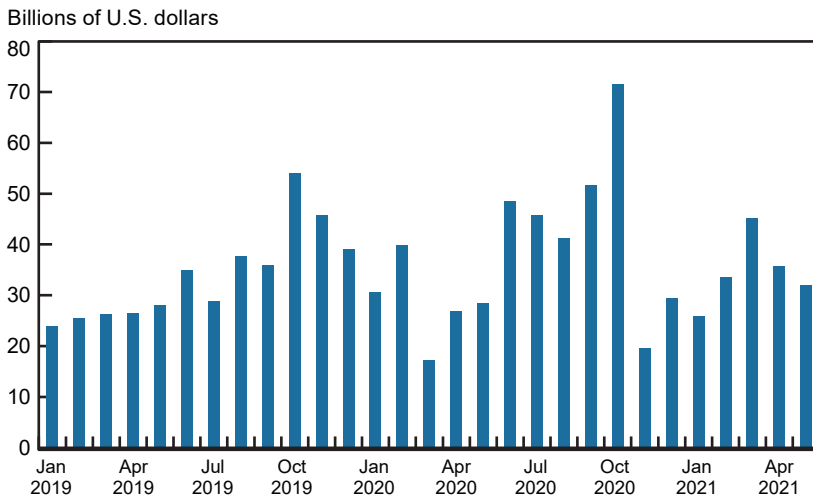

Source: SIFMA.

cash flow needs of these states and localities (yet where localities do not tax incomes but instead rely on property taxes, this change would not have a direct impact).¹⁰ Given the importance of final income tax settlements in those states where the income tax is a significant revenue source, the delay itself was consequential, and it became even more of an issue when combined with the fourth major concern, the “freezing up” of the municipal market, which we describe next.

The municipal bond market, like other financial markets, became severely stressed as the pandemic began to take hold in March 2020. Yields on municipal securities spiked in mid-March, and issuance dried up almost entirely (see Chart 3). For example, the average yield on a AAA-rated thirty-year bond rose 180 basis points between March 2 and March 23, and issuance fell well below its average levels for the prior five years (Cipriani et al. 2020).¹¹ At the moment when a clear need for short-term liquidity was presenting itself, the market for lending was drying up. Chart 4 shows this spike, and also the rapid recovery that followed for most but not all issuers.

An important correlate of the increase in market stresses in the beginning of March was mutual fund outflows. Open-end mutual funds are the largest institutional investors in municipal securities, holding about 20 percent of outstanding municipal bonds. Although mutual funds’ municipal holdings are smaller than those of retail investors, the impact of their redemptions on municipal bond yields was substantial during March 2020. In the first two months of 2020, mutual funds investing in municipal securities had received inflows totaling \$22 billion. This continued a trend of record inflows experienced throughout 2019, when total inflows were \$90 billion. But the direction reversed suddenly in March, resulting in outflows of \$43 billion in that month alone (Cipriani et al. 2020). Li, O’Hara, and Zhou (2021) show that the behavior of issues held by mutual funds, while similar to that of issues not held by funds before the COVID-19 pandemic, diverges both during and after the crisis. Specifically, the drastic increase in trading volume during the crisis was entirely driven by the trading

CHART 4
 Turmoil in Secondary Municipal Bond Yields during COVID-19

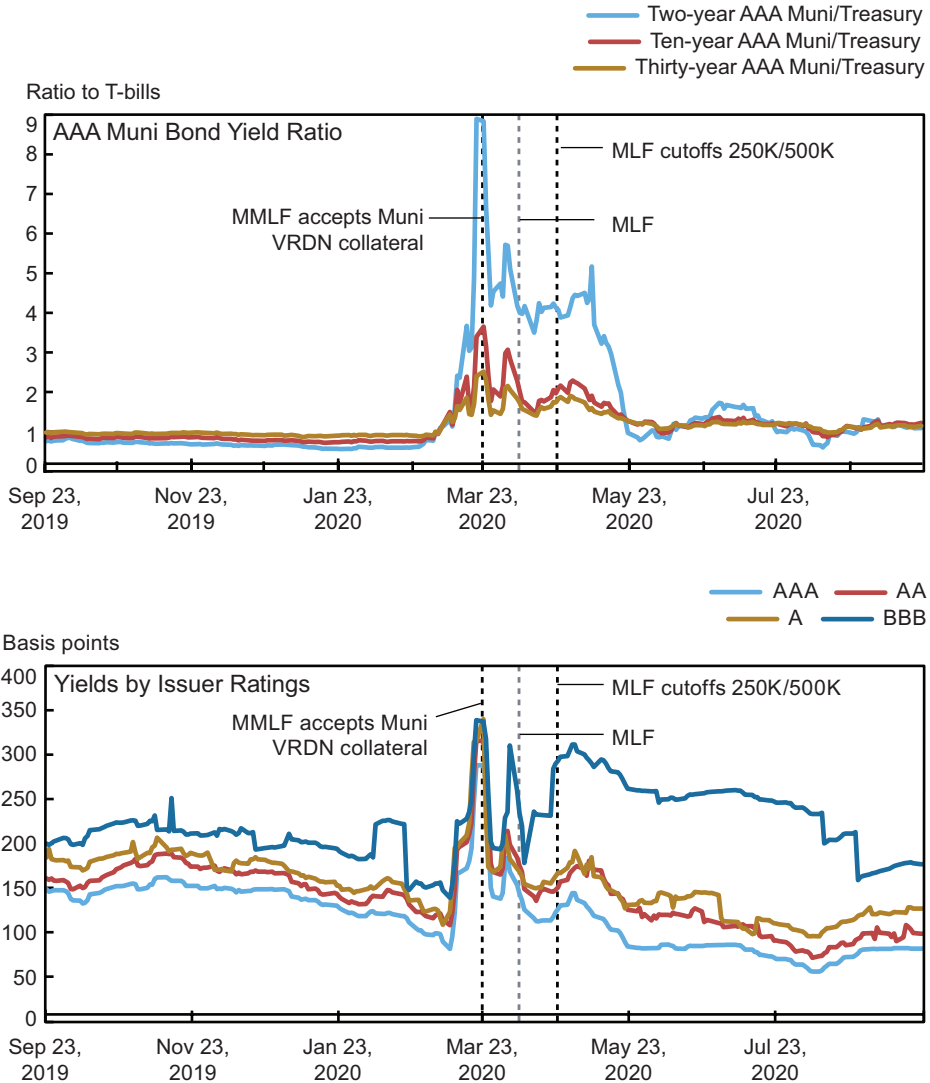

Source: Haughwout, Hyman, and Shachar (2021).

Notes: VRDN is variable-rate demand note. MMLF is Money Market Mutual Fund Liquidity Facility. MLF is Municipal Liquidity Facility. The MLF’s population cutoffs for county and city issuers were 500,000 and 250,000, respectively.

of bonds held by mutual funds, and bonds that suffered larger redemptions experienced larger price deterioration.

This combination of a sharply deteriorating revenue picture, a pressing need for additional expenditures, delays in the receipt of substantial taxes owed, and an inability to access the financial markets was enough to raise serious concerns among many observers about the

ability of state and local governments to continue to meet their public service delivery responsibilities.

3. THE MUNICIPAL LIQUIDITY FACILITY

3.1 Purpose and Size

On April 9, 2020, the Federal Reserve announced the establishment of the MLF to help state and local governments manage the cash flow challenges that the pandemic produced. MLF was a direct result of the Coronavirus Aid, Relief, and Economic Security Act (CARES Act), which, among many other things, directed the U.S. Treasury Department to make loans or investments in Federal Reserve facilities intended to provide “liquidity to the financial system that supports lending to eligible business, states or municipalities.”¹² Treasury committed to invest up to \$35 billion in the special purpose vehicle that was set up to operate the facility, and initially funded \$17.5 billion, thus sharing any credit risk with the Federal Reserve.¹³ Treasury’s investment was drawn from the Exchange Stabilization Fund.

The facility was announced as having a \$500 billion lending limit, a figure that far exceeded the typical issuance in the market for short-term municipal notes, which had been less than \$100 billion in 2019. There were indeed unusually severe strains on liquidity in the sector, as discussed in Section 2, and estimates of the demand for short-term lending were quite uncertain, so the figure was intended to be large enough to send an important signal to the market. As Kent Hiteshew, who served as Deputy Associate Director for Financial Stability at the Federal Reserve Board and was instrumental in the creation and implementation of the MLF, stated subsequently, “Rather than an attempt at measuring actual loan demand, the \$500 billion MLF sizing was based more on the goal of making sure the market understood that the Fed and Treasury were fully committed to using all of our resources to support stabilization and then restore normalization of the municipal market.”¹⁴ Indeed, the \$500 billion facility size was approximately equal to 20 percent of the “own source general and utility revenue” (OSGUR) of *all* state and local governments in 2017. The closing date for the facility—the date after which it would cease purchasing notes—was set at December 31, 2020.

The initial MLF term sheet accompanying the announcement on April 9 was ultimately amended, as shown in Exhibit 1, which provides a detailed timeline of MLF developments. Nonetheless, these subsequent changes to the eligibility and terms of the MLF left its purpose and this \$500 billion overall size unchanged.

3.2 Eligible Issuers, Notes, and Borrowing Limits

The April 9 announcement defined “eligible issuers” as all fifty states, the District of Columbia, cities with a population exceeding one million, and counties with populations exceeding two million. Population figures were taken from the U.S. Census Bureau’s most recent complete data: 2018 for cities and 2019 for counties.

EXHIBIT 1

Municipal Liquidity Facility (MLF) Timeline

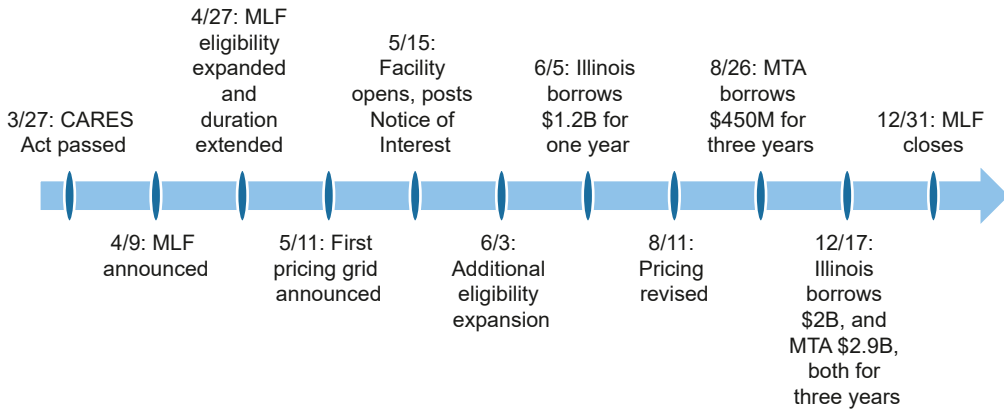

Source: Authors' calculations from MLF public announcements.

Limiting eligibility in this way was intended to ensure that the facility would not face an unmanageable number of counterparties. If even a relatively small portion of the municipal bond market's 50,000 issuers had sought funding from the MLF, the facility would have faced significant administrative challenges, as noted by Hiteshew in his September 20, 2020, Congressional Oversight Commission testimony. In addition, the initial language of the term sheet suggested that eligible issuers might use their borrowing as a mean of supporting their "political subdivisions and instrumentalities," suggesting the potential that MLF funding could be "downstreamed" to cities, towns, and authorities, including those that were not directly eligible for the facility. The idea was that states, which have significant experience allocating funding to their subdivisions, in particular might act like a clearinghouse for the provision of liquidity from the Federal Reserve to where it was needed most.¹⁵ Even if states were unable or unwilling to provide liquidity to their smaller municipalities, the provision of liquidity directly to some of the largest issuers in the market (states and the largest sub-state general purpose governments, which are responsible for the vast majority of trades in the market), combined with the facility's large size, was thought to help ensure that the market would open for all issuers.¹⁶

Nonetheless, the relatively small number of issuers eligible under the initial announcement drew criticism on a variety of grounds.¹⁷ On April 27, the Federal Reserve released a revised term sheet expanding eligibility to cities with population above 250,000 and counties over 500,000 as well as certain "multi-state entities," such as the Port Authority of New York and New Jersey.¹⁸ This change constituted a fairly major expansion of eligibility but still left several states in which the state government was the sole eligible borrower. On June 3, facility eligibility was expanded further to include at least two cities or counties in each state, as well as up to two additional municipal issuers "whose revenues are generally derived from operating government activities," a reference to transit systems, airports, and other utilities.¹⁹ The later expansions of eligibility opened the door to additional issuers, and specific language was added to the term sheet to ensure that the issuers held an investment-grade rating as of April 8, 2020. This date allowed for the possibility that "fallen angel" issuers, whose ratings were reduced as a consequence of the pandemic, could access the facility.

The maximum maturity for eligible notes in the original announcement was twenty-four months from date of issuance to the facility; this maximum was extended on April 27 to thirty-six months. The relatively short maturity was intended to provide assistance that reflected the realities of municipal issuers' fiscal institutions and that states and localities would generally be able to actually use. (Recall that the use of long-term borrowing is typically sharply restricted under state and local law.) Indeed, many municipalities must repay short-term borrowing within the fiscal year, but the expectation was that some would be able to relax these tight constraints somewhat, making a two- or three-year term practicable. In any event, the CARES Act called for a facility that would support the cash management needs of states and municipalities, and this was an additional argument for restricting maturities.

Issuance limits were determined by the size of the eligible *government*, as measured by own-source general plus utility revenue in fiscal year 2017, as reported by the Census of Governments. The use of Census of Governments data was intended to avoid complications from variations in accounting standards. Census of Governments data are self-reported by the governments in question and are reported in a standard accounting by the Census Bureau. Data for 2017 were chosen in part because they were already publicly available at the facility's inception and were based on a census (a 100 percent sample) rather than the smaller samples used in years between censuses.

The decision to use the OSGUR revenue concept reflects the complexity of the sector, which receives revenues from its own activities as well as from other levels of government and from the operation of insurance trust funds such as those for employee pensions. OSGUR is a measure of the revenue that governments, including their dependent public utilities like water districts or transit systems, raise themselves, generally through taxes and fees. The share—20 percent—was chosen to reflect the potential for a very severe downturn as well as the timing issues that were expected to arise from the change of the federal tax filing deadline to July 15, producing a large facility of about \$500 billion. The facility size was approximately equal to 20 percent of the OSGUR for all the governments in the sector.

3.3 Pricing

On May 11, the Federal Reserve released the initial pricing schedule for MLF lending. Prices for tax-exempt issues were expressed as a series of spreads to overnight index swap rates (OIS), with the spreads ranging from 150 basis points for AAA/Aaa-rated issuers to 380 basis points for BBB-/Baa3 issuers.²⁰ Below-investment-grade issuers were assigned a spread of 590 basis points. Taxable issues were priced at the applicable tax-exempt rate divided by 0.65 to reflect the value of the tax exemption. Each issue to the MLF was also required to pay an origination fee equal to 10 basis points of the principal amount.

These rates were, as required by the Federal Reserve's Regulation A for its Section 13(3) programs, set as "penalty" rates relative to normal market pricing.²¹ Nonetheless, MLF rates were criticized by many for being too punitive, especially for higher-rated borrowers after the market began to normalize. On August 11, as spreads in the market came down, MLF pricing was reduced by 50 basis points across the board, producing the price schedule shown in Table 1.²² Taxable rates were reduced somewhat more, as the adjustment factor went from 0.65 to 0.70, thereby narrowing the spread between the tax-exempt and taxable rates.

TABLE 1

Municipal Liquidity Facility (MLF) Pricing Schedules for Tax-Exempt Issues

Rating	Spread to OIS (Basis Points)	
	May 11, 2020	August 11, 2020
AAA/Aaa	150	100
AA+/Aa1	170	120
AA/Aa2	175	125
AA-/Aa3	190	140
A+/A1	240	190
A/A2	250	200
A-/A3	265	215
BBB+/Baa1	325	275
BBB/Baa2	340	290
BBB-/Baa3	380	330
Below investment grade	590	540

Source: MLF Term Sheet - Appendix B, August 11, 2020. <https://www.federalreserve.gov/newsevents/pressreleases/files/monetary20200811a1.pdf>.

Note: OIS is overnight indexed swap.

These revised rates generally remained above the rates that could be found in private markets for issuers in most credit ratings, although the substantially slower recovery of yields for issues carrying lower credit ratings meant that MLF participation was attractive for the relatively small set of issuers in the A and BBB ratings groups. Indeed, only lower-rated issuers actually issued notes to the facility during its lifetime, providing indirect evidence of the importance of the pricing. We discuss more fully the impact of the facility across the ratings distribution in the next section.

3.4 Operations, Issuance, and Wind-Up

Under the MLF, the Federal Reserve Bank of New York (the Reserve Bank administering the facility) committed to lend to a special purpose vehicle (SPV) on a recourse basis, secured by all of the assets of the SPV. The New York Fed was the managing member of the SPV, which was known as Municipal Liquidity Facility LLC. The SPV purchased eligible notes directly from eligible issuers at the time of issuance. The MLF officially opened on May 11 with the posting of a Notice of Interest and instructions for how eligible issuers could participate in the program. Eligible issuers were instructed to determine their financial needs and repayment schedule, then inform the New York Fed of their intention to participate.²³ The New York Fed and the SPV hired several vendors to consult on the MLF's structure, to evaluate the credits presented, and to administer the facility.²⁴

Over the MLF's lifetime, only two issuers actually sold notes to the facility: the state of Illinois and New York's Metropolitan Transportation Authority (MTA). Table 2 reports the details

TABLE 2
Municipal Liquidity Facility (MLF) Transactions

Issuer Name	Type of Governmental Entity	CUSIP	Date Transaction Entered Into	Closing Date	Face Value of Note When Issued to the MLF (Dollars)	Maturity Date of Note	Interest Rate or Coupon on Note (Percent)	Origination Fee (Dollars)
State of Illinois	State	4521526N6	6/2/2020	6/5/2020	1,200,000,000	6/5/2021	3.36	1,200,000.00
State of Illinois	State	4521527U9	12/14/2020	12/17/2020	2,000,000,000	12/15/2023	3.42	2,000,000.00
Metropolitan Transportation Authority (NY)	Designated Revenue Bond Issuer	59261AG92	8/18/2020	8/26/2020	450,720,000	8/1/2023	1.93	450,720.00
Metropolitan Transportation Authority (NY)	Designated Revenue Bond Issuer	59261CAA1	12/9/2020	12/17/2020	2,907,280,000	12/15/2023	1.33	2,907,280.00

Source: MLF-specific transactions disclosures, May 10, 2021. See <https://www.federalreserve.gov/monetarypolicy/muni.htm>.

of these transactions. Illinois's issuance of a total of \$3.2 billion represented about one-third of the state's maximum eligible borrowing, but the MTA ultimately borrowed its maximum allowable amount, \$3.358 billion.

It is notable that both of these issuers were relatively low-rated by the nationally recognized statistical rating organizations.²⁵ Illinois's average rating was BBB- at the time of both of its issuances to the facility, while the MTA's original note, secured by an anticipated Transportation Revenue Bond issue, was priced advantageously given a favorable rating from Kroll, Inc.²⁶ The MTA's second, December, note was secured by an anticipated Payroll Mobility Tax bond issue, which was rated AA+/Aa1. Not surprisingly, issuers appear to have compared the rates they would be required to pay to the MLF with market pricing and chosen whichever option offered the lowest rates. The MTA's initial \$450 million issue, for example, received competitive bids of 2.79 percent, versus the 1.93 percent it received from the MLF.²⁷ The state of New Jersey considered a \$4 billion sale to the MLF but reported that its advisor found market pricing more advantageous, and the state issued publicly instead.²⁸ For both Illinois and the MTA, MLF pricing for the financing they sought was the most favorable, or at a minimum favorable enough to make the utilizing the facility appealing. The fact that both were relatively low-rated issuers suggests that MLF terms were somewhat more favorable for riskier borrowers, although take-up of the facility was quite low even among low-rated issuers. We discuss this subject further below.

On November 19, 2020, then-Treasury Secretary Steven Mnuchin sent a letter to Fed Chair Jerome Powell requesting that the Federal Reserve return the unused portion of the Treasury's initial investment in the various facilities that were supported by Treasury funding, including the MLF, effectively enforcing the closure of the facility to new purchases, as scheduled, on December 31.²⁹ As shown in Table 2, the MLF's two borrowers, Illinois and the MTA, each completed a transaction shortly before the closure, in mid-December. On June 5, 2021, Illinois completed repayment of its initial \$1.2 billion note, having voluntarily prepaid the debt starting in November 2020.

4. EFFECTS OF THE MUNICIPAL LIQUIDITY FACILITY

Between mid-March (when the CARES Act was announced and stated that the Treasury and the Federal Reserve would provide cash management assistance to municipal borrowers) and the official closure of the MLF at the end of 2021, municipal market conditions improved significantly. This improvement can be seen in a variety of measures, from secondary market yields (see Chart 4) to issuance. Indeed, by year-end, municipal issuance in 2020, in the midst of a pandemic, reached \$484 billion—a record total and 14 percent above the 2019 level.³⁰ The improvement was not even across the board, however, and the recovery for the lowest-rated segment of the market was considerably slower, as can be seen in the chart. Nonetheless, by late summer, even BBB yields had retraced most, if not all, of the spikes that occurred in March.

While the overall recovery in the market during the first few months of the MLF's existence is dramatic and undeniable, it is challenging to determine what, if any, of this improvement can be attributed to the facility itself. Both the facility's announcement and its opening occurred at the same time as other federal interventions. For example, the Federal Reserve's Money Market

Mutual Fund Liquidity Facility (MMLF) was established on March 18. Mutual funds are major holders of municipal securities, and they had experienced \$43 billion in outflows during March, a figure equal to almost half the previous year's inflows. Similarly, the CARES Act included \$150 billion in funding for a new Coronavirus Relief Fund, which provided support for state and local governments to cover expenses related to COVID-19. In addition, the Federal Open Market Committee voted to cut the federal funds rate to a range of 0-0.25 percent by March 16.

To a very small sample of market participants who offered feedback on the facility to the authors, the MLF was clearly associated with substantially improved market functioning, although many also attributed a significant role to other elements of the federal government's interventions—particularly the MMLF but also CARES Act direct aid and the fact that the state and local government revenue picture improved dramatically as the year progressed.

The body of research on the effect of all these interventions, collectively and individually, is relatively small at this early date. Bi and Marsh (2020) study the impact of varied fiscal and monetary policy interventions on municipal bond market performance in the wake of COVID-19 by analyzing daily time series effects around the various announcements. They do not focus explicitly on the MLF, but find that long-term, low-rated bonds remained distressed beyond the various federal government interventions. Bordo and Duca (2021) further focus on the time series impact of the MLF announcement on yield spreads, and find that the MLF limited the growth of spreads by 5 to 8 percentage points. Li and Lu (2020) focus on the effects of shutdown announcements on offering yields (rather than trade prices) and find that initial offering yields increased in response to shutdowns and decreased following facility announcements. Both Bordo and Duca (2021) and Li and Lu (2020) are consistent with a view that the various facilities (the MLF in particular, according to Bordo and Duca) played a significant role in calming the municipal market. But as noted, the close timing of many of the facility and other policy announcements makes separating their effects in the aggregate difficult.

In a novel approach to this problem, Haughwout, Hyman, and Shachar (2021) combine the time series and cross-sectional variations in availability of MLF funding to identify the effect of the facility on bond yields, issuance, ratings downgrades, and local public sector employment. The facility's population cutoffs for county and city issuers (500,000 and 250,000, respectively) were relatively arbitrary figures generally intended to limit the facility's eligibility to a manageable number of potential counterparties.

After demonstrating that counties and cities just above and just below these cutoffs are quite similar fiscally prior to the announcement of the MLF, Haughwout, Hyman, and Shachar (2021) look for differences in outcomes based on facility access. The headline result is that conditions overall improved after the MLF was announced, but the improvement was uneven across the credit rating distribution, and for the lowest-rated city and county issuers, which are here measured as those with ratings of A or BBB, actual eligibility to borrow at the facility translated into lower secondary market yields. The authors attribute this eligibility effect to a reduction in downgrade or default risk for these issuers, as they would be differentially able to remain liquid thanks to the option to borrow from the MLF. These authors also find a modest effect of MLF eligibility on primary market issuance, particularly among low-rated municipalities. Their test for effects of eligibility on the probability of a ratings downgrade also suggests a modest MLF effect, with downgrades rarer for issuers that had the option to receive funding from the MLF. Between March and November 2020, the number of bonds by cities and counties just below the population cutoff rose from 100 to 600, while they went from 100 to about 200 over the same period for

issuers just above the cutoff. In this case, the MLF eligibility effect was not related to the starting level of credit risk but, given the relative rarity of ratings changes, it is not estimated precisely.

A final contribution of Haughwout, Hyman, and Shachar (2021) is their attempt to identify the effect of MLF eligibility on local government employment. While the authors are able to demonstrate clearly that the largest cities and counties reduced employment by less than their slightly smaller counterparts, they are unable to attribute this difference to the MLF. The CARES Act's Coronavirus Relief Fund, which as noted above made \$150 billion in grants to many of the same governments, acts as a confounder here, and the authors conclude after a series of tests that the fund appears more likely than the MLF to have driven the employment results.

5. DISCUSSION AND CONCLUSION

The rapid healing of the municipal securities market after its sharp deterioration, along with the overall improvement in the fiscal health of state and local governments, is a clear success story of the pandemic policy response. Nonetheless, as of mid-2021, the state and local government sector had still not recovered to its pre-pandemic employment level. Indeed, employment as of May 2021 remained more than a million jobs (about 6 percent) below its pre-pandemic peak of February 2020 and has shown little sign thus far of a substantive recovery despite a substantial brightening of the fiscal outlook for the sector. It seems probable that some of this weakness is attributable to caution in a sector that was hit hard in the 2007-09 recession and its aftermath. Further, as noted above, the fact that many of these job losses have been concentrated in education suggests that there may be a nonfiscal reason for them, as in-person schooling was not feasible for most of the 2020-21 school year, leading to greatly reduced need for nonteaching staff such as bus drivers and cafeteria workers.

Given its focus on the ability of municipal issuers to access capital and liquidity, it is hard to resist the conclusion that the MLF was successful, if only as a component of a broad portfolio of policy interventions: record issuance at low interest rates suggests an issuer-friendly environment for much of 2020 and into 2021. How much credit the MLF deserves for this outcome is debatable, but market participants and the relevant academic literature provide evidence that some credit is due. Certainly, the MMLF was an important secondary market complement to the MLF's primary market focus. Indeed, some observers asked whether the Federal Reserve should have designed a secondary market facility for municipal debt, analogous to the Secondary Market Corporate Credit Facility.³¹ While the MLF was always focused on the primary market, the original (April 9) announcement of the MLF stated:

In addition to the actions described above, the Federal Reserve will continue to closely monitor conditions in the primary and secondary markets for municipal securities and will evaluate whether additional measures are needed to support the flow of credit and liquidity to state and local governments.³²

Some observers interpreted this sentence to mean that the Federal Reserve would establish a secondary market facility if needed for liquidity purposes, a need that ultimately did not materialize in the judgment of policymakers.

Nonetheless, the MLF had very low take-up, especially relative to the size of the market it was designed to support and relative to the announced size of the facility. This outcome was the subject of considerable discussion at a Congressional Oversight Commission hearing where some policymakers criticized the facility's limited eligibility and penalty pricing as overly blunting its impact.³³

The initial concern was that a facility of this type—directly lending in a market in which the Federal Reserve had never participated and had little expertise, and which consisted of a very large number of heterogeneous issuers—could easily be overwhelmed by demands for funds. This consideration led to strict eligibility limits both in terms of issuers and tenors, limits that were slowly relaxed over the subsequent revisions to the term sheet. At the same time, the adoption of a pricing schedule at penalty rates (as required by law) in the face of a stabilizing market environment made the MLF uneconomic to the vast majority of borrowers who were eligible. A reasonable conclusion to draw from this set of facts is that, even in a market with many issuers, penalty pricing acts as a significant deterrent to facility utilization—meaning that complex eligibility criteria may further complicate the Federal Reserve's ability to deliver funding where it is most needed. Further research on this topic is warranted, specifically focused on the price elasticity of demand for short-term borrowing by municipal issuers in an environment of fiscal stress. Given the size and heterogeneity of the issuer population in the municipal market, policymakers would need to know the elasticity on both the extensive margin (how many new issues would be made at price X?) and the intensive margin (how much would be borrowed at price X?). Estimates of these elasticities are important inputs into the design of a future facility like the MLF and could greatly simplify and streamline decisions about eligibility and borrowing limits by linking them with the setting of the penalty prices.

The challenge, of course, is identifying price shocks exogenous to borrower characteristics that can allow causal estimation of the effect of prices on issuance. Using their regression discontinuity design, Haughwout, Hyman, and Shachar (2021) estimate that among city and county issuers rated A/BBB, MLF eligibility caused a 75 basis point (or about 25 percent) reduction in yields. This exogenous variation in pricing, which is admittedly rare, might be used to identify the effects of prices on yields. In the paper, Haughwout, Hyman, and Shachar estimate some issuance response by A/BBB issuers, on both the extensive and intensive margins. The point estimate suggests elastic demand, but the sample sizes are very small: only five A/BBB cities or counties issued public debt in the six months following the April 27 expansion of the facility, four of which were eligible to borrow at the MLF.³⁴ These estimates have the advantage of being well-identified but suffer from a lack of precision and the fact that they are drawn from a sample of low-rated issuers, a thin part of the issuer population. Future work could focus on refining and expanding analysis along these lines.

A second lesson learned from the MLF experience is that investors, perhaps not surprisingly, appear to have placed a high value on facility eligibility by lower-rated borrowers. In the end, the MLF lent to just two borrowers: the state of Illinois (the lowest-rated state government) and the MTA, a relatively low-rated revenue bond issuer. Further, Haughwout, Hyman, and Shachar's (2021) results suggest that secondary market investors perceived a lower default risk for A/BBB cities and counties with facility access than for those without. The notion that the greatest benefit of access to Federal Reserve lending accrues to riskier borrowers suggests a potential for credit risk sharing or a change in the "normal" allocation of credit attributable to such a facility. The welfare implications of public sector risk sharing

or credit allocation are complex, especially when considerations of equity among the constituencies of various subnational public sector entities are included. Further research is required to understand these implications, as well as the relationship between access to liquidity and welfare in these areas.

A corollary concern is moral hazard. Borrowers might expect the Federal Reserve to reestablish such a facility if similar market dysfunction were to occur again, inducing borrowers to take more risk today. Bordo and Duca (2021) review past episodes in the United States and in other countries where state and local governments have not internalized borrowing risks due to previous national bailouts, which then resulted in a wave of defaults when such bailouts have failed to be realized.

Some characteristics of the pandemic context and the facility itself may serve to mitigate these moral hazard concerns to some degree. First, the pandemic was a unique event, with effects across the entire spectrum of municipal borrowers and indeed the entire economy. As Chair Powell testified in December 2020: “These programs serve as a backstop to key credit markets and have helped restore the flow of credit from private lenders through normal channels. We have deployed these lending powers to an unprecedented extent.”³⁵ Second, the MLF’s very low take-up rate appears to have been induced in part by the combination of eligibility restrictions and penalty pricing, suggesting that for the vast majority of municipal bond issuers it was not an attractive option compared to private markets. Third, the improvements in overall market functioning that followed the introduction of the MLF and other federal interventions were slowest to appear for lower-rated issuers—those in the A and BBB market segments.

Of course, none of these mitigants is completely convincing and there remain reasons for concern over moral hazard. For example, under exactly what future circumstances the Federal Reserve might again intervene in the municipal bond market is unknown, and it is possible that municipal budget officials will be overly optimistic about the probability of a future intervention of this sort in any number of scenarios. Further, these officials could imagine that a future version of the facility might be designed to be a more attractive option to individual borrowers, and/or to provide more immediate support to the bottom of the ratings distribution. Our conclusion, then, is that once a new kind of backstop lending has been introduced, and the MLF certainly fits that description, the issue of moral hazard can never be satisfactorily resolved *ex ante* but will require further monitoring.

A final point is the elusive relationship between access to liquidity and real economic outcomes like state and local government employment. In the 2020 recession, unlike the 2007-09 downturn, state and local governments shed jobs very quickly, and thus far the recovery has been tepid—this in spite of unprecedented interventions in the credit market, including the MLF, and large fiscal transfers. Whether the MLF had any positive impact on real outcomes, including capital investment or service delivery more generally, is a third area for additional research. This is of course a key question, one that will require better data and perhaps new research designs to untangle.

NOTES

Acknowledgments: The authors are grateful for comments from the editor, an anonymous referee, Won Chai, Anna Kovner, Timothy Little, Byron Lutz, Susan McLaughlin, and Jennifer Wolgemuth.

¹ For the purposes of this article, we will use broad terms like “state and local government sector,” “state and local governments,” “municipal issuers,” and “municipalities” to refer to the vast array of subnational governmental entities in the United States, including states, cities, counties, transit agencies, and school districts, among others.

² This is not to say that such bonds can never be used to help fund current operations. For example, bonding against tobacco settlement payments or pension obligation bonds can be used as means to reduce near-term budget pressures. See Calabrese and Ely (2013) and Johnson (2004). State and localities can also use rainy day funds and accounting maneuvers of various sorts to smooth their spending through recessions.

³ See Bernanke (2020).

⁴ By mid-autumn, unemployment was down to 6.7 percent and it had become clear that the most dire scenario for the sector was less likely.

⁵ Bruce and Fox (2000) point out the relatively heavy taxation of goods versus services in state sales tax systems.

⁶ “Own-source” revenues are those collected by the entity in question, as opposed to those transferred from other governments.

⁷ Indeed, by the end of fiscal year 2021, thanks to an improving economy and aid under the American Rescue Plan, many states and localities were proposing spending increases and/or tax cuts. See the Urban Institute’s “How the COVID-19 Pandemic Is Transforming State Budgets,” <https://www.urban.org/policy-centers/cross-center-initiatives/state-and-local-finance-initiative/projects/state-fiscal-pages-covid-edition>.

⁸ “Running on Fumes: Impact of COVID-19 on County Finances,” Issue Brief, National Association of Counties, April 2020. <https://www.naco.org/sites/default/files/documents/Impact%20on%20County%20Finances-FINAL-v2.pdf>. The Coronavirus Relief Fund component of the CARES Act was intended to help localities fund these expenditures.

⁹ Dadayan (2020).

¹⁰ Alan Cohen and Michael Madowitz, “The Need for Direct Assistance to Local Governments in Response to the Coronavirus,” Center for American Progress, May 26, 2020. <https://www.americanprogress.org/issues/economy/news/2020/05/26/485396/need-direct-assistance-local-governments-response-coronavirus/>.

¹¹ Cipriani et al. (2020).

¹² See Section 4003 of the CARES Act. <https://www.congress.gov/bill/116th-congress/house-bill/748>.

¹³ The MLF was one component of a very broad suite of programs intended to respond to the pandemic’s effects on the economy; some of those programs also provided aid to state and local governments. For example, the CARES Act also established a Coronavirus Relief Fund that provided direct grants to states and large localities. The breadth of these programs increases the challenge of isolating the effect of the MLF, as we will discuss below.

¹⁴ Joseph Mysak, Jr., “For Hiteshew, Fed Muni Backstop Sent Crucial Message,” Bloomberg, April 14, 2021. <https://www.bloomberg.com/news/articles/2021-04-14/for-hiteshew-fed-muni-backstop-sent-crucial-message-joe-mysak>.

¹⁵ Over a quarter of local government revenue in fiscal year 2017 was intergovernmental aid from state governments. This “downstream” funding is also similar in spirit to the support a “proactive” state will give to a financially distressed municipality under its jurisdiction (Gao, Lee, and Murphy 2019). Other states, however, allow unconditional access to Chapter 9 bankruptcy procedure, preferring to leave the municipalities to manage their own affairs in a period of fiscal stress.

¹⁶ Testimony of Kent Hiteshew before the Congressional Oversight Commission, September 17, 2020. <https://coc.senate.gov/municipal-liquidity-facility>, at 59:30.

NOTES (CONTINUED)

¹⁷ See, for example, Aaron Klein and Camille Busette, “Improving the Equity Impact of the Fed’s Municipal Lending Facility,” Brookings Institution report, April 14, 2020. <https://www.brookings.edu/research/a-chance-to-improve-the-equity-impact-of-the-feds-municipal-lending-facility>.

¹⁸ “Federal Reserve Board Announces an Expansion of the Scope and Duration of the Municipal Liquidity Facility,” Federal Reserve Board press release, April 27, 2020. <https://www.federalreserve.gov/newsevents/pressreleases/monetary20200427a.htm>. Last accessed June 25, 2021.

¹⁹ “Federal Reserve Board Announces an Expansion in the Number and Type of Entities Eligible to Directly Use its Municipal Liquidity Facility,” Federal Reserve Board press release, June 3, 2020. <https://www.federalreserve.gov/newsevents/pressreleases/monetary20200603a.htm>. Last accessed June 25, 2021.

²⁰ “Federal Reserve Publishes Updates to the Term Sheet for the Municipal Liquidity Facility,” Federal Reserve Board press release, May 11, 2020. <https://www.federalreserve.gov/newsevents/pressreleases/monetary20200511a.htm>. Ratings were at the issuer level, given as the average of the Nationally Recognized Statistical Rating Organizations.

²¹ See Code of Federal Regulations, 12 C.F.R. 201.4(d)(7). <https://www.ecfr.gov/current/title-12/chapter-II/subchapter-A/part-201/section-201.4>.

²² “Federal Reserve Board Announces Revised Pricing for Its Municipal Liquidity Facility,” Federal Reserve Board press release, August 11, 2020. <https://www.federalreserve.gov/newsevents/pressreleases/monetary20200811a.htm>.

²³ The facility was officially a special purpose vehicle called Municipal Liquidity Facility LLC and was incorporated in Delaware. See “Municipal Liquidity Facility Notice of Interest,” May 11, 2020, at <https://www.newyorkfed.org/medialibrary/media/markets/mlf-notice-of-interest>.

²⁴ Municipal Liquidity Facility, Federal Reserve Bank of New York. See: Vendors. <https://www.newyorkfed.org/markets/municipal-liquidity-facility>.

²⁵ The nationally recognized statistical rating organizations for MLF purposes were S&P Global Ratings, Moody’s Investor Service, Inc., Fitch Ratings, Inc., and Kroll Bond Rating Agency, Inc.

²⁶ See “New York’s MTA Is Saved Less by Fed and More by Kroll,” Bloomberg, August 19, 2020. <https://www.bloomberg.com/opinion/articles/2020-08-19/new-york-s-mta-saved-less-by-fed-and-more-by-kroll>.

²⁷ “New York’s MTA Sells Over \$450M in Debt to Fed’s Municipal Liquidity Facility,” S&P Global Market Intelligence, August 18, 2020. <https://www.spglobal.com/marketintelligence/en/news-insights/latest-news-headlines/new-york-s-mta-sells-over-450m-in-debt-to-fed-s-municipal-liquidity-facility-59983543>.

²⁸ “New Jersey Picks Muni Market Over Fed for \$4 Billion Bond Sale,” Reuters, October 22, 2020. <https://www.reuters.com/article/usa-new-jersey-fed-bonds/new-jersey-picks-muni-market-over-fed-for-4-billion-bond-sale-idUSL1N2HD1ZD>.

²⁹ See letter at <https://home.treasury.gov/system/files/136/letter11192020.pdf>.

³⁰ SIFMA, U.S. Municipal Bonds Statistics. <https://www.sifma.org/resources/research/us-municipal-bonds-statistics/us-municipal-bonds-statistics-sifma/>.

³¹ See, for example, an October 14, 2020, letter to Treasury Secretary Mnuchin and Fed Chair Powell from the Government Finance Officers Association, International City/County Management Association, National Association of Counties, National Association of State Auditors, Comptrollers, and Treasurers, National Association of State Treasurers, National League of Cities, and U.S. Conference of Mayors, at https://gfoaorg.cdn.prismic.io/gfoaorg/55818178-59da-41f8-ba44-383849bc85ed_MLFCoalitionLetter_FINAL.pdf.

NOTES (CONTINUED)

³² “Federal Reserve Takes Additional Actions to Provide up to \$2.3 Trillion in Loans to Support the Economy,” Federal Reserve Board press release, April 9, 2020. <https://www.federalreserve.gov/newsevents/pressreleases/monetary20200409a.htm>.

³³ Congressional Oversight Commission, Hearing on Municipal Liquidity Facility, September 17, 2020. <https://coc.senate.gov/municipal-liquidity-facility>.

³⁴ These few issues were about 44 percent larger than the placebo mean.

³⁵ See “Fed Chair Calls the Economic Recovery ‘Extraordinarily Uncertain,’” *CNN Business*, December 1, 2020. https://lite.cnn.com/en/article/h_56bf6ed733f9c4124446cf991fd94e6e.

REFERENCES

- Appleson, J., A. Haughwout, and E. Parsons.* 2012. “The Untold Story of Municipal Bond Defaults.” Federal Reserve Bank of New York LIBERTY STREET ECONOMICS, August 15. <https://libertystreeteconomics.newyorkfed.org/2012/08/the-untold-story-of-municipal-bond-defaults/>.
- Auerbach, A., W. Gale, B. Lutz, and L. Sheiner.* 2020. “Fiscal Effects of COVID-19.” BROOKINGS PAPERS ON ECONOMIC ACTIVITY, BPEA Conference Draft, Fall. <https://www.brookings.edu/bpea-articles/fiscal-effects-of-COVID-19/>.
- Bernanke, B.* 2020. “I Was Chairman of the Federal Reserve. Save the States.” NEW YORK TIMES, July 15.
- Bi, H., and B. Marsh.* 2020. “Flight to Liquidity or Safety? Recent Evidence from the Municipal Bond Market.” Federal Reserve Bank of Kansas City, Research Working Paper no. 20-19, December. <https://www.kansascityfed.org/documents/7596/rwp20-19.pdf>.
- Bordo, M. D., and J. V. Duca.* 2021. “How the New Fed Municipal Bond Facility Capped Muni-Treasury Yield Spreads in the COVID-19 Recession.” NBER working paper no. 28437. <https://www.nber.org/papers/w28437>.
- Boyarchenko, N., A. Kovner, and O. Shachar.* 2020. “It’s What You Say and What You Buy: A Holistic Evaluation of the Corporate Credit Facilities.” Mimeo, Federal Reserve Bank of New York.
- Bruce, D., and W. Fox.* 2000. “E-Commerce in the Context of Declining State Sales Tax Bases.” NATIONAL TAX JOURNAL 53, no. 4, part 3 (December): 1373-90.
- Calabrese, T. D., and T. L. Ely.* 2013. “Pension Obligation Bonds and Government Spending.” PUBLIC BUDGETING AND FINANCE 33, no. 4 (Winter): 43-65. <https://doi.org/10.1111/j.1540-5850.2013.12022.x>.
- Cipriani, M., A. Haughwout, B. Hyman, A. Kovner, G. La Spada, M. Lieber, and S. Nee.* 2020. “Municipal Debt Markets and the COVID-19 Pandemic.” Federal Reserve Bank of New York LIBERTY STREET ECONOMICS, June 29. <https://libertystreeteconomics.newyorkfed.org/2020/06/municipal-debt-markets-and-the-COVID-19-pandemic/>.
- Dadayan, L.* 2020. “State Revenue Forecasts before COVID-19 and Directions Forward.” Tax Policy Center, Urban Institute and Brookings Institution, April 2. https://www.urban.org/sites/default/files/publication/101962/state-revenue-forecasts-before-covid-19-and-directions-forward_1.pdf.
- Fiedler, M., and W. Powell.* 2020. “States Will Need More Fiscal Relief. Policymakers Should Make that Happen Automatically,” Brookings Institution, April 2. <https://www.brookings.edu/blog/usc-brookings-schaeffer-on-health-policy/2020/04/02/states-will-need-more-fiscal-relief-policymakers-should-make-that-happen-automatically/>.

- Gao, P., C. Lee, and D. Murphy.* 2019. “Municipal Borrowing Costs and State Policies for Distressed Municipalities.” *JOURNAL OF FINANCIAL ECONOMICS* 132, no. 2: 404–26.
- Green, R. C., D. Li, and N. Schürhoff.* 2010. “Price Discovery in Illiquid Markets: Do Financial Asset Prices Rise Faster than They Fall?” *JOURNAL OF FINANCE* 65, no. 5: 1669–1702.
- Haughwout, A., B. Hyman, and O. Shachar.* 2021. “The Option Value of Municipal Liquidity: Evidence from Federal Lending Cutoffs during COVID-19.” Mimeo, Federal Reserve Bank of New York.
- Johnson, C. L.* 2004. “The State of the Tobacco Settlement: Are Settlement Funds Being Used to Finance State Government Budget Deficits? A Research Note.” *PUBLIC BUDGETING AND FINANCE* 24, no. 1: 113–25. <https://doi.org/10.1111/j.0275-1100.2004.02401006.x>.
- Li, T., and J. Lu.* 2020. “Municipal Finance during the COVID-19 Pandemic: Evidence from Government and Federal Reserve Interventions.” Mimeo, University of Florida. https://papers.ssrn.com/sol3/papers.cfm?abstract_id=3637636.
- Li, Y., M. O’Hara, and X. (A.) Zhou.* 2021. “Mutual Fund Fragility, Dealer Liquidity Provisions, and the Pricing of Municipal Bonds.” Mimeo. https://mendoza.nd.edu/wp-content/uploads/2021/01/2-mutual_fund_fragility.pdf.
- McNichol, E., and M. Leachman.* 2020. “States Continue to Face Large Shortfalls Due to COVID-19 Effects.” Center on Budget and Policy Priorities. <https://www.cbpp.org/research/state-budget-and-tax/states-continue-to-face-large-shortfalls-due-to-COVID-19-effects>.
- Moody’s.* 2020. “U.S. Municipal Bond Defaults and Recoveries, 1970–2019.” Moody’s Data Report.

THE MAIN STREET LENDING PROGRAM

David Arseneau, José Fillat, Molly Mahar, Donald Morgan, and Skander Van den Heuvel

OVERVIEW

- The Main Street Lending Program was created in 2020 to support credit to small and medium-sized businesses and nonprofits harmed by the COVID-19 pandemic, particularly those in the “missing middle” in terms of size, which were unsupported by other pandemic-response programs.
- The facility marked the Federal Reserve’s most direct involvement in the business loan market since the 1930s and 1940s and operated by buying 95 percent participations in loans from lenders and sharing the credit risk with them.
- Ultimately, Main Street supported more than 2,400 borrowers and co-borrowers across the U.S. with loans totaling \$17.5 billion, the most of any Federal Reserve credit purchase facility.
- This article describes the facility’s goals and design, the challenges and constraints it faced, and the characteristics of its borrowers and lenders. It also offers lessons learned for future policymakers and facility designers.

In March 2020, it became clear that the COVID-19 pandemic would cause widespread economic disruptions that would harm many U.S. businesses and households. Moreover, there was acute uncertainty about the duration and ultimate severity of the economic and financial harm. Many businesses with the ability to draw down on their existing credit lines did so—either to cover revenue shortfalls or to boost cash holdings as a precautionary measure. At the same time, banks appeared to be tightening the supply of new credit in response to the resulting uncertainty.

These conditions motivated the Federal Reserve and the Department of the Treasury to create the Main Street Lending Program (Main Street), first announced at the end of March 2020. As one of several credit facilities set up in response to the pandemic, Main Street was intended in particular to help those businesses that were too small to benefit from the Federal Reserve’s corporate credit programs but too large to qualify for the loans and grants available through the Paycheck Protection Program (PPP). Filling that support gap was uniquely challenging because the targeted firms depend

David Arseneau is an assistant director and Skander Van den Heuvel an associate director in the Federal Reserve Board’s Division of Financial Stability. Molly Mahar is a senior associate director in the Board’s Division of Supervision and Regulation. José Fillat is a senior economist and policy advisor in the Federal Reserve Bank of Boston’s Research Department. Donald Morgan is a financial research advisor in the Federal Reserve Bank of New York’s Research and Statistics Group. Emails: david.m.arseneau@frb.gov, jose.fillat@bos.frb.org, molly.e.mahar@frb.gov, don.morgan@ny.frb.org, skander.j.vandenheuvel@frb.gov.

The views expressed in this article are those of the authors and do not necessarily reflect the position of the Federal Reserve Bank of New York, the Federal Reserve Bank of Boston, or the Federal Reserve System. To view the authors’ disclosure statements, visit https://www.newyorkfed.org/research/epr/2022/epr_2022_MSLP_arseneau.html.

primarily on bank loans (versus bonds) that are highly differentiated (“bespoke”) and largely untraded. Reaching that corner of credit markets required an entirely new type of credit facility built from the ground up. It was also, incidentally, the Federal Reserve’s most direct intervention in the bank loan market since it lent directly to businesses briefly in the 1930s and 1940s (Sablík 2013). Despite the challenges, Main Street wound up supporting more than 2,400 borrowers and co-borrowers across the United States with loans totaling \$17.5 billion, the most of any Federal Reserve credit purchase facility.¹

This article tells the story of Main Street so far. We first revisit the credit conditions in spring 2020 that motivated the decision by the Federal Reserve and the Treasury to embark on such a program. Second, we describe how Main Street was designed to support credit supply by purchasing loan participations from banks and other lenders and sharing credit risk with them. Third, we analyze the reach of Main Street, including take-up, characteristics of borrowers and lenders, and factors that likely limited its take-up, such as certain program features and much weaker loan demand after a surge in the spring. We conclude with some lessons learned for future policy makers and facility designers. We caution that some of these lessons are preliminary, since most Main Street loans are still outstanding.

1. BANK CREDIT CONDITIONS IN THE SPRING OF 2020

A crucial goal of Main Street was to reach the “missing middle” of firms—those too large for PPP support but too small to benefit from the Federal Reserve’s support of the corporate bond market.² Tens of thousands of U.S. firms have more than 500 employees (the PPP cutoff) but are not rated to issue bonds; these firms instead depend on banks (or other intermediaries) for credit.³ So, the story of Main Street begins with bank credit conditions in the spring of 2020. By most indications, bank credit was tight, with firms demanding additional credit at the same time that banks were contracting supply. And since the missing middle depends on banks, the apparent crunch would likely affect them most.

The need for credit was suggested by the remarkable, if temporary, surge in bank business lending in the spring (Chart 1). Commercial and industrial loans on banks’ books rose by over a half a trillion dollars in the first few months of the pandemic. The Federal Reserve’s Senior Loan Officers Survey (SLOOS) also indicated increasing demand for loans at the time. The surge in demand was important in motivating Main Street, but the eventual reversal figures later in how Main Street played out.

Much of this borrowing reflected firms drawing against their credit lines with banks.⁴ Most large, corporate firms have committed lines from a bank for working capital and to back their commercial paper. Those firms switch between bank and public debt according to which is cheaper; they are not very bank-dependent because they have alternatives. In contrast, more detailed, firm-level data suggested at the time that some of the credit needs of smaller firms might be going unmet, despite the surge in total credit. As shown in Chart 2, commitment borrowing by firms with less than \$5 billion in annual sales (the eventual revenue cutoff at Main Street) grew notably more slowly than for larger firms above that cutoff.⁵

At the same time loan demand was increasing, banks appeared to be contracting supply. The SLOOS revealed that banks raised risk premiums (Chart 3, left panel) and tightened standards for

CHART 1
Business Loans at Banks Surged in the Spring of 2020

C & I loans, all commercial banks (billions of dollars)

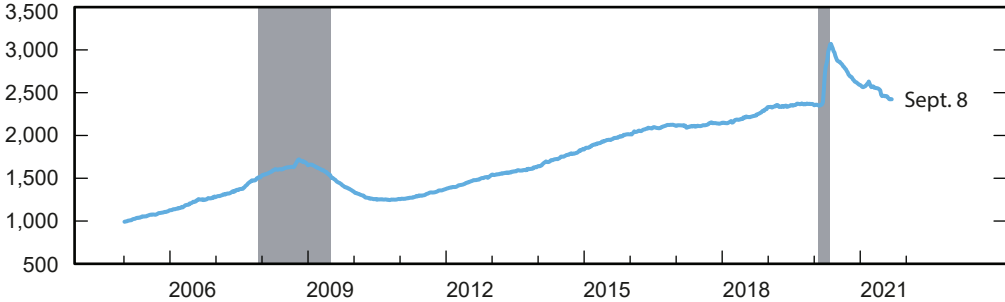

Source: Federal Reserve H.8 Statistical Release, “Assets and Liabilities of Commercial Banks in the United States.”

Notes: C&I is commercial and industrial. Shaded areas indicate periods designated as recessions by the National Bureau of Economic Research.

CHART 2
Lower Commitment Borrowing by Firms with Less Than \$5 Billion in Revenues

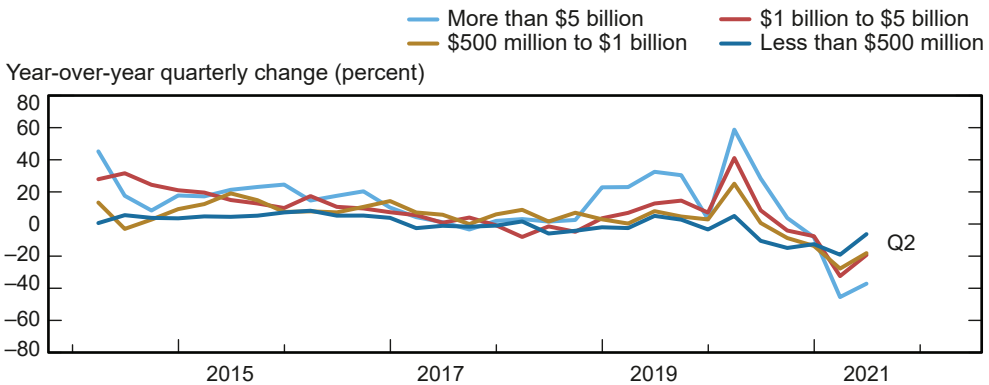

Source: Federal Reserve Report FR-Y14Q, “Capital Assessments and Stress Testing.”

Notes: The chart shows growth in utilized commitments of commercial and industrial (C&I) loans to U.S. nonfinancial firms that report revenue (FR Y-9C category 4).

new loans (right panel) in the first half of 2020. “Standards” includes the sorts of loan terms, such as covenants and collateral requirements, that distinguish loans from less bespoke (“vanilla”) bonds.

While the net fraction of banks that reported tightening credit was about equal for firms of all sizes, it is important to note that bank-dependent firms would be more affected than larger firms with access to public debt markets, supported by the Federal Reserve’s corporate facilities.⁶ The SLOOS in the spring of 2020 also revealed that banks were tightening primarily because of the “less favorable or more uncertain economic outlook” and “reduced tolerance for risk.” While not surprising, that risk aversion and uncertainty informed the design of Main Street.

CHART 3

Banks Tightened Credit Supply in the Spring of 2020

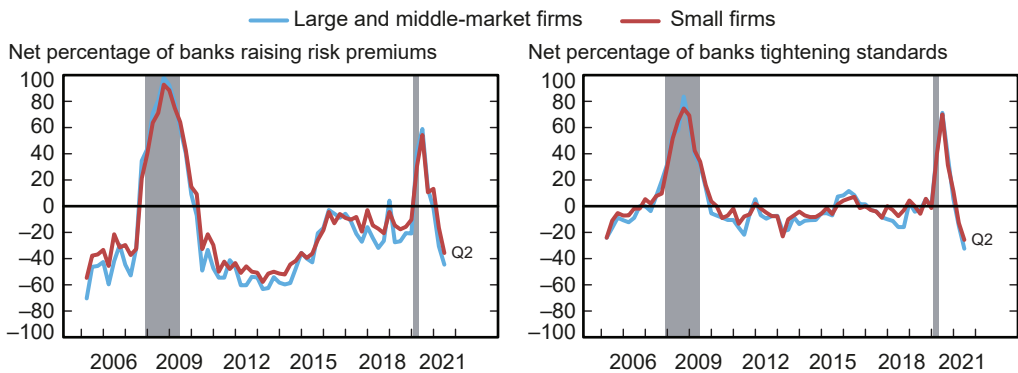

Source: Federal Reserve, Senior Loan Officer Opinion Survey on Bank Lending Practices.

Notes: Large and middle-market firms are those with annual sales above \$50 million. Shaded areas indicate periods designated as recessions by the National Bureau of Economic Research.

It was this picture of surging demand and contracting supply in the spring of 2020 that led the Federal Reserve to declare its intention to create a program to support credit to small and medium-sized firms.⁷ The actual program that emerged in the second half of 2020 is the topic of the next section.

2. THE DESIGN OF MAIN STREET

Designing Main Street was a complex undertaking. This section describes the overall objectives of Main Street, the structure of the program, including key considerations that shaped its design, and its implementation. As policymakers set out to design the program, they focused on creating facilities that would make credit available to a sufficiently wide scope of firms affected by the pandemic but, at the same time, limit risk to taxpayers. While a number of policy, legal, and operational considerations shaped the program, the need to strike this careful balance underpinned all key design decisions.

2.1 Program Objectives and Key Considerations

With Main Street, the Federal Reserve and the Treasury sought to provide credit support to small and medium-sized businesses and nonprofits impacted by the pandemic. The goal of Main Street was to assist businesses and nonprofits that faced credit constraints but were in sound financial condition prior to the pandemic and had good post-pandemic prospects, so that they were in a position to benefit from—and be able to repay—a loan. As already noted,

Main Street was intended to complement the Federal Reserve’s corporate credit and municipal lending facilities that were launched to support larger businesses, states, and municipalities.

Several characteristics of the market for loans to small and medium-sized businesses highlighted above created challenges. These loans are not traded like bonds or securitized like mortgages; such markets (which tend to bring infrastructure, ratings, real-time prices, and a degree of standardization) could otherwise have provided convenient on-ramps for program design. Moreover, loans to small and medium-sized firms are some of the more individually tailored (bespoke) financial contracts—more bespoke than traded bonds or residential mortgages. Owing to the importance of relationship lending for these businesses, policymakers were left without a readily available, standardized set of loan terms or credit metrics that could easily be converted into a program term sheet and quickly scaled for thousands of businesses.

Additionally, while it was difficult to predict the scale and scope of demand for the program from the outset, conditions in the spring of 2020 pointed to large potential demand. Although the Federal Reserve is very experienced in credit analysis for its supervision and monetary policy functions, it would have needed to hire a large number of loan officers to directly originate and process loans to the thousands of companies that could potentially have qualified. Hiring such personnel quickly and in sufficient numbers from the banking sector, which was itself facing unprecedented demand for loans, was impractical—thus necessitating a role for private lenders. The swift onset of the pandemic and the fact that the Federal Reserve lacked previous experience setting up a small and medium-sized business credit support program also created design complications.

The program was authorized under Section 13(3), as amended, of the Federal Reserve Act and was capitalized, in part, by funds appropriated under the CARES Act; each act influenced the specific design of the Main Street facilities. Section 13(3) provides lending authority but prohibits loans to “insolvent” borrowers and requires that the lending Reserve Bank be “indorsed or otherwise secured” to its satisfaction.⁸ (See Box 1 for a brief history of Federal Reserve credit policy directed specifically to businesses under Section 13(3).) The application of the CARES Act set forth eligible borrower criteria and placed limits on borrowers’ ability to distribute capital or set compensation above given thresholds.⁹

2.2 Program Design

With these economic, operational, and legal considerations as a backdrop, policymakers at the Federal Reserve and the Treasury settled on a loan participation program to support the supply of credit. Banks would be able to sell 95 percent stakes in eligible loans at par to the Main Street special purpose vehicle (SPV), with the credit risk shared between the SPV and lenders pro rata.

The loan participation model was chosen for three reasons. First, it leveraged lenders’ existing infrastructure for originating, monitoring, and servicing loans as well as their expertise in assessing and controlling risk—expertise that is often local and specialized.

Second, because the participation model transferred the bulk of the loans and associated risks from the lenders to the Main Street program, it helped mitigate the acute economic uncertainty and risk aversion that was driving the tightening credit supply in the spring. As an added benefit, removing 95 percent of the loan amounts from banks’ balance sheets would also free up bank capital to recognize losses and maintain lending outside the Main Street program.¹⁰

BOX 1

The Federal Reserve's Historical Experience with Direct Lending to Businesses

The Main Street program represented the first time since World War II that the Federal Reserve actively pursued policies to direct bank lending to the nonfinancial business sector. The origins of the Fed's previous experience with direct lending to businesses traces back to the addition of Section 13(3) to the Federal Reserve Act, which occurred during the Great Depression.^a

In January 1932, legislation was passed to create the Reconstruction Finance Corporation (RFC), which was designed to make short-term loans to banks and other financial institutions, collateralized by real bills (short-term debt from businesses). The creation of the RFC was a means of injecting capital into the weakened banking system; however, the RFC's ability to extend loans outside of the banking system was limited. Recognizing this, Congress passed a bill in the summer of 1932 that added Section 13 paragraph 3 to the Federal Reserve Act.

Congress further expanded the lending authority of the Federal Reserve by adding Section 13(b) to the Federal Reserve Act in June 1934.^b Section 13(b) allowed Reserve Banks to directly extend loans to businesses within their districts for periods of up to five years. It also gave the Reserve Banks the ability to participate in loans with lending institutions, provided those lending institutions retained 20 percent of the risk of the loan. In contrast with Main Street, no limitations were placed on the size of an individual loan. This Great Depression-era facility was funded in equal part by the surplus of the Reserve Banks as of mid-1934 and the Treasury. All told, nearly \$280 million (\$5.4 billion in 2020 dollars) was made available for Reserve Bank lending, with each of the twelve Districts being apportioned a partial amount of the total. Relative to the overall size of the economy, this quantity of funding was about 0.5 percent of GDP in 1934. In comparison, Main Street's capacity as a share of 2020 GDP was about six times as large.^c

By May 1935, roughly a year after the passage of Section 13(b), the Federal Reserve System had approved 961 loans issued directly to businesses totaling \$43.9 million (\$847.9 million in 2020 dollars). Interestingly, as a share of contemporaneous GDP, this uptake is nearly identical to Main Street's. Because each Reserve Bank had access to funds, lending was, by design, dispersed geographically across all twelve Districts. In addition, the loans went to a broad range of industries, including construction, lodging, manufacturing, mining, transportation, and wholesale and retail trade—many of the same industries that took Main Street loans.^d All told, loan volume peaked at about \$60 million by the end of 1935 (\$1.2 billion in 2020 dollars). With peak volume amounting to more than 15 percent of the total funds available, utilization was much higher relative to Main Street.^e Main Street's lower utilization likely reflects that it operated for only about six months, and also that the program designs differed notably.

The Federal Reserve's lending activity to nonfinancial businesses gradually declined after 1935 as expanded lending through the RFC made direct loans from the Federal Reserve less attractive.

(CONTINUED ON NEXT PAGE)

^a For an extensive treatment of this history see Hackley (1973).

^b For useful summaries of the history of Section 13(b), see Fettig (2002) and Sablik (2013).

^c With Treasury's equity commitment and the SPV's leverage cap, up to \$600 billion was potentially available through Main Street, about 3 percent of the size of the \$20.9 trillion U.S. economy in 2020.

^d See Sablik (2013) for more details on the industry composition of 13(b) loans as of mid-1935.

^e Main Street loan volume totaled \$17.4 billion at the end of 2020, about 3 percent of the \$600 billion in total available funding.

BOX 1 (CONTINUED)

Section 13(b) remained in place and, in fact, activity peaked again in 1942 when the Federal Reserve was called upon to make industrial loans during World War II. The role of the Federal Reserve in allocating credit to businesses remained a hotly debated issue throughout the 1950s, but ultimately Section 13(b) was repealed in 1958. The 13(3) powers, however, remained part of the Federal Reserve Act and played an important role in implementing Main Street in response to the COVID-19 pandemic.

Third, the participation model allowed for an appropriate balance between reach and risk. The substantial risk-bearing by the Federal Reserve promoted reach, while the residual bank risk-bearing maintained some economic incentives for lenders to control risk. To complement these incentives and further minimize the risk of adverse selection—the possibility that banks would offload their worst new loans to Main Street—the Main Street program also limited borrower leverage and imposed requirements for priority and collateral.

The program was executed through an SPV set up by the Federal Reserve Bank of Boston that was funded with a loss-absorbing tranche of Treasury equity (that is, CARES Act funds), as well as loans from the Reserve Bank. Given the widespread uncertainty at launch, Main Street was created with a sizable maximum capacity of up to \$600 billion in participations, in case that much support would be needed.

Main Street officially began purchasing loan participations on July 6, 2020. It offered to purchase participations in three distinct types of loans—new loans, priority loans, and expanded loans—through three separate facilities: Main Street New Loan Facility (MSNLF), Main Street Priority Loan Facility (MSPLF), and Main Street Expanded Loan Facility (MSELF), respectively. While certain terms were common across all three loan types, there were also important differences, including loan size, permissible leverage levels, and collateralization requirements to accommodate a range of borrower and lender circumstances. The term sheets were posted for public feedback and were adjusted in response to such feedback several times, both before and after the start of operations, as discussed below. The final loan terms for the for-profit facilities are shown in Table 1.

Loan terms

While the terms for small and medium-sized business loans are generally tailored to the facts and circumstances of the borrower, some Main Street loan terms were standardized to allow the program to function while balancing reach and risk. For example, standardized interest rates and loan maturities enabled Main Street to purchase participations at par without the need to develop a complex loan pricing model. An interest rate of LIBOR plus 300 basis points with zero prepayment penalty implemented the Regulation A requirement that Federal Reserve emergency lending be extended at a sufficiently high rate of interest relative to non-stressed conditions to provide an incentive for rapid repayment when conditions normalize. In keeping with the

TABLE 1

Key Main Street Loan Terms of Facilities for For-Profit Borrowers (Final Terms)

	New Loan Facility	Priority Loan Facility	Expanded Loan Facility
Loan term	5 years		
Principal payments	Principal deferred for two years. Years 3-5: 15 percent, 15 percent, 70 percent, respectively		
Interest payments	Deferred for one year		
Interest rate	1- or 3-month LIBOR + 3 percent		
Loan size	\$100,000 to \$35 million	\$100,000 to \$50 million	\$10 million to \$300 million
Maximum combined debt to adjusted 2019 EBITDA (including principal amount of Main Street loan)	4 times	6 times	6 times
Lender participation rate	5 percent		
Federal Reserve participation rate	95 percent		
Prepayment allowed	Yes, without penalty		
Business size limits	15,000 employees or fewer, or 2019 revenues of \$5 billion or less		

Source: Board of Governors of the Federal Reserve System. <https://www.federalreserve.gov/monetarypolicy/mainstreetlending.htm>.

objective of helping borrowers bridge the pandemic, Main Street loans were given an amortization schedule that back-loaded loan repayment, deferral of interest and principal payments for a year (principal payments were later deferred for two years), and a five-year loan term. The deferral was intended to alleviate short-term financial strain on Main Street borrowers.

Lenders had discretion over loan size up to a limit, either a nominal dollar limit or a leverage limit, whichever was smaller. The leverage limit, which turned out to be more binding, was a primary mechanism for limiting risk to the program. When added to the borrower's existing debt, the Main Street loan could not exceed four (MSNLF) or six (MSPLF, MSELF) times the borrower's 2019 adjusted earnings before interest, taxes, depreciation, and amortization (EBITDA). In addition to limiting the size of Main Street loans for participants, these leverage limits also had the effect of excluding some highly levered or unprofitable firms altogether. The choice to use 2019 EBITDA was motivated by the program's goal to help borrowers that were temporarily suffering from the pandemic but that had been fundamentally solvent prior to the onset of the pandemic.

In addition to the leverage limits and the lender's risk retention, the tradeoff between risk and reach was also managed through security and priority requirements. All Main Street loans were prohibited from being contractually subordinated to any existing borrower debt in terms of priority in bankruptcy. While priority and expanded loans allowed higher leverage than new loans, they were required to be senior to, or *pari passu* with, all existing borrower debt in terms of collateral securing the loans, except for mortgage debt (as defined by the program). Lenders were ultimately responsible for determining that borrowers were in sound condition prior to the crisis and had strong post-pandemic prospects that would enable repayment of the Main Street loan.

Finally, the program allowed borrowers to refinance existing debt, but only in a single facility, the MSPLF, and only debt owed to a different lender, to avoid the risk that lenders would shift poorly performing debt on their own books to the program.

Borrowers

To target small and medium-sized businesses, the program limited eligibility to firms with fewer than 15,000 employees or less than \$5 billion in annual revenues (including affiliates).¹¹ To help those businesses that lacked access to an alternative support program, these caps were deliberately set above those used for the PPP (500 employees) or other Small Business Administration (SBA) lending (with size thresholds that vary by industry) but lower than the level at which a company might generally have access to financing in capital markets and thus be supported by the Federal Reserve's corporate credit facilities. The aforementioned nominal loan size limits, all well above the \$10 million maximum for the PPP, played a similar role. In other words, Main Street was intended to fill a gap in credit support for the "missing middle."

In defining eligibility criteria, the Board also referenced the SBA's exclusion of "ineligible businesses"—a list of categories formulated especially to place reasonable limits on the types of companies that could receive government-backed business lending.¹² This framework, particularly the definition of ineligible business, was designed to mitigate fraud risk and limit evasion of facility restrictions.¹³ Further, Main Street program borrowers were subject to the requirements for participants in direct loan programs set forth in the CARES Act. In particular, a borrower needed to commit to follow compensation, stock repurchase, and capital distribution restrictions under Section 4003(c)(3)(A)(ii) of the Act. These requirements would remain in place until a year after the Main Street loan was fully repaid.

Lenders

All Main Street facilities relied on private lenders and their existing underwriting infrastructure to apply appropriate expertise and enable the program to scale rapidly. In contrast to the PPP, which allowed a broad set of eligible lenders to supply its forgivable loans, the Main Street program limited eligible lenders to federally regulated and supervised organizations, including banks and credit unions, to ensure that Main Street lenders' underwriting standards and "know your customer"/anti-money laundering practices were subject to strong and ongoing supervisory oversight.¹⁴ While a wider set of eligible lenders might have extended the reach of the program, the use of established and well-regulated banking organizations and credit unions was viewed as an important way to control potential taxpayer risks in the program. As it turns out, virtually all of the participating lenders were commercial banks (as we discuss later), so for brevity we will often refer to eligible lenders simply as "banks."

Under the program terms, lenders were expected to underwrite Main Street loans using their existing underwriting practices. Subsequent program guidance provided through FAQs also clarified supervisory expectations. Lenders were directed to underwrite Main Street loans by looking at borrowers' pre-pandemic financial condition and post-pandemic prospects.¹⁵

Lender incentives and the participation agreement

Several incentives for banks to participate were built into the program, since, to be successful, Main Street required the active participation of lenders. First, as discussed above, the risk-sharing with Main Street allowed banks to help existing and new customers without taking on much new credit risk or needing to significantly expand their own balance sheets. Second, to cover lenders' loan origination and servicing costs and further boost incentives, lenders were able to benefit from fees: an origination fee of up to 1 percent (on the full principal) and an annual servicing fee of 0.25 percent of the Main Street SPV's loan share.¹⁶ Given the banks' limited initial investment, these fees, together with banks' 5 percent share in interest and principal repayments, in principle, enabled a lender to receive reasonable returns even under the most adverse credit scenarios considered (discussed further below). That said, for loans with significant origination or servicing costs, the lender's return would be lower. While data on origination and servicing costs are scant, commercial and industrial (C&I) loan fees can be significant, possibly suggesting that such costs are also significant. For example, in the market for syndicated term loans to businesses, upfront fees (where observed) average about 80 basis points, with considerable variation around that average (Berg, Saunders, and Steffen 2016). In addition, lender incentives in the MSELF were complicated due to interactions with the loan that was being expanded, including the possibility that the collateral on the existing loan was diluted.¹⁷

To operationalize the loan participation model, the Federal Reserve created a loan participation agreement based on market-standard models, with adjustments for certain features of the program. The market-standard provisions were generally familiar to lenders that use participations or engage in syndicated lending; this was intended to help smooth the on-ramp for many potential lenders. While these documents were less familiar to the program's smaller borrowers, they played an important function in the program because their provisions were generally viewed as facilitating a "true sale," which (among other things) enabled lenders to move 95 percent of the loan amounts off their balance sheets for purposes of bank capital rules, thus promoting lender participation by freeing up regulatory capital.

In comment letters and outreach, lenders expressed concerns that the Federal Reserve would "put back" nonperforming loans to the lenders by arguing that the loans were originated imprudently. To alleviate such concerns and promote participation, the Federal Reserve added a clause to the agreement preventing put-backs. The Federal Reserve also waived and disclaimed its rights to special priority in bankruptcy among unsecured lenders to enhance the efficacy of the program and provide certainty to lenders and borrowers.

Income and loss projections during the design phase

Section 13(3) of the Federal Reserve Act and the CARES Act required that the Federal Reserve's investment be appropriately secured and that taxpayers be protected. Accordingly, when deciding on loan terms, risk-sharing arrangements, and fees, the Federal Reserve and Treasury had to gauge the effect of these choices on the potential gains or losses from Main Street's operations. To do so, staff projected bounds for the SPV's net income under various credit risk scenarios and design choices, akin to a stress test. Multiple scenarios, with varying degrees of adversity, were used, both to ensure that the statutory taxpayer-protection

requirement would be satisfied under a range of adverse conditions and because at the time that the program was being designed the economic outlook was extremely uncertain. The appendix describes the scenarios and projections in more detail.

The results of these projections also guided the decision to cap SPV “leverage” at 8-to-1. Given Treasury’s planned \$75 billion equity investment, the net leverage cap dictated a maximum program size of \$600 billion. With that cap, even under adverse scenarios, the Federal Reserve was projected to incur zero losses.

Infrastructure

Once the design was generally decided on, the next step was to build, from the ground up, the technological infrastructure and risk control mechanisms needed to operate the program. The loans in which Main Street would be participating could not simply be purchased “in the market” as with the corporate credit programs, so the Federal Reserve Bank of Boston (which operates the program) had to create an electronic portal through which banks could register and submit loans for participation. To address the risk of fraud or processing mistakes, multi-step processes that would verify lender registrations and loan documents had to be developed. All told, building this infrastructure from scratch was a complicated task given the lack of an existing blueprint, and this complexity slowed the launch relative to other credit facilities implemented by the Federal Reserve or loan programs in other countries that were built on existing infrastructure. (See Box 2 for more details on how other central banks and governments facilitated the flow of credit to small and medium-sized businesses).

When submitting a loan, lenders uploaded the loan agreements and other relevant loan documents to the portal. Automated eligibility checks were augmented by a manual review for adherence to certain core program requirements; the review was done by Federal Reserve Bank of Boston staff and hired vendors, including the Main Street credit administrator and external counsel. Importantly, the SPV did not re-underwrite Main Street loans.

Additional program adjustments

In an effort to respond to the credit needs of nonprofit organizations and smaller borrowers, a need that became increasingly apparent in summer and early fall 2020, Main Street was amended to introduce two facilities for small and medium-sized nonprofit organizations—the Nonprofit Organization New Loan Facility (NONLF) and the Nonprofit Organization Expanded Loan Facility (NOELF)—and to enable the facilities’ participation in smaller loans.

The nonprofit sector was hit particularly hard by the social-distancing requirements put in place to slow the pace of the pandemic. Demands for their services (for example, care for COVID-19 patients, online learning, and social services) spiked at the same time key sources of income (such as elective surgical procedures, tuition, and donations) declined or were at risk of declining. Designing a program for this sector presented additional challenges, given that many nonprofits were designed to minimize rather than maximize earnings, making it difficult to meet the program’s pre-pandemic leverage thresholds, and many had limited experience

Box 2

Lending Programs to Support Nonfinancial Businesses During the Pandemic: The International Experience

The COVID-19 pandemic had a significant effect on small- to medium-sized businesses not only in the United States but in countries throughout the world. Accordingly, an important aspect of the policy response in many countries involved creating lending programs, some of which were similar to Main Street, to support the flow of credit to households and nonfinancial businesses.

The most similar international programs were the Bounce Back Loan Scheme (BBLS) and the Coronavirus Business Interruption Loan Scheme (CBILS), both implemented in the United Kingdom, and the Prêt Garanti par l'État (PGE), implemented in France. In the broadest sense, the intent of these programs was to facilitate lending to nonfinancial businesses that were hit hard by the pandemic and that, absent support, could potentially be forced to reduce employment and economic activity.^a One common feature of all three of these programs is that the loans were either fully or partially backed by government guarantees of repayment in the event that the borrower defaults. This feature significantly reduces the amount of exposure a bank faces and, as a result, makes participation more attractive. In contrast, the strong desire to protect taxpayers by not guaranteeing loans made the Main Street program different from the BBLS, the CBILS, and the PGE.

Beyond these lending programs, many central banks acted unilaterally (that is, not in conjunction with the country's Treasury or the Ministry of Finance) to promote credit to certain segments of the credit market. In this regard, the most common policy response was to establish a funding-for-lending scheme, whereby the central bank provides low-cost funding to banks that then use those funds to extend loans to a targeted set of borrowers (small and medium-sized enterprises, or SMEs).^b Examples of targeted funding-for-lending programs introduced by foreign central banks include those implemented by the Bank of England (the Term Funding Scheme with Additional Incentives for SMEs), the Bank of Japan (the New Fund-Provisioning Measure to Support Financing Mainly of Small and Medium-Sized Firms), the European Central Bank (the modified Targeted Longer-Term Refinancing Operations III), the Reserve Bank of Australia (the Term Funding Facility), and the Sveriges Riksbank (Loans to Banks for Onward Lending to Companies).

The Main Street Lending Program is very different from a funding-for-lending scheme. In the simplest terms, the difference boils down to what creates the incentive for a participating bank to increase lending to a targeted set of borrowers. Under a funding-for-lending scheme this incentive comes from low-cost funding provided by the central bank, while under Main Street it comes from the opportunity to originate a loan and sell a large portion of the risk to the Federal Reserve while still retaining the servicing rights.

^a See Briggs and Walker (2020) for a fuller discussion.

^b See Cantu et. al., (2021) and Cavallino and DeFiore (2021).

managing longer-term debt. The terms of the nonprofit facilities sought to balance these challenges by setting out different and additional eligibility requirements to capture those for which a loan product would be most beneficial.¹⁸

Similarly, policymakers received repeated feedback during the life of the program that some small businesses and nonprofits would benefit from a loan smaller than the minimum size permitted originally. In response, the program was adjusted to allow for loans as low as \$100,000 in the MSNLF, MSPLF, and NONLF. The program fees were also adjusted upward for the smallest loans, in order to compensate lenders for the proportionally larger potential cost associated with originating small loans.

4. MAIN STREET ACTIVITY

Over its six-month run, Main Street purchased 1,830 loans with a combined principal amount of \$17.5 billion, more than any of the Federal Reserve's other debt-purchase programs. Its volume, although small relative to capacity, was a meaningful addition to the flow of credit—roughly comparable, for example, to the amount of lending by the largest banks (those with consolidated assets greater than \$100 billion) over the second half of 2020 to borrowers with similar characteristics, that is, within the eligibility parameters but outside the Main Street program. This section describes in detail Main's Street activity and its limits, including loan, lender, and borrower characteristics.

A look at the portfolio yields the following high-level observations. The average loan was \$9.5 million, substantially larger than the average PPP loan, suggesting the program supported firms too large for PPP loans. Loan size was often dictated by the program's leverage limits defined above (of four and six times EBITDA). The lenders were nearly all commercial banks. Most active lenders were in the \$250 million to \$10 billion asset-size range, although the largest banks (those with assets of more than \$1 trillion) also participated to some extent. The program's reach was wide, with borrowers from nearly all states, and state-level activity tended to correlate positively with COVID-19 cases and increases in a state's unemployment rate. Borrowers were, on average, somewhat riskier than the typical borrower found in the portfolios of the largest banks, possibly reflecting differences between the types of borrowers that seek loans from the largest banks and those that seek loans from other banks (that is, those with assets of less than \$1 trillion).

4.1 Overall Activity

The program began accepting participations on July 6, 2020, and ended on January 8, 2021. Activity grew modestly but steadily until early December, when it surged in advance of the December 14 deadline for submitting new participations (see Chart 4, left panel). Roughly half of the overall volume of the program occurred in the final month of the program.¹⁹ All told, the late surge in loan purchases pushed Main Street's volume above that of any debt purchase (versus liquidity) facility created by the Federal Reserve during the pandemic (right panel).²⁰

CHART 4

Loan Purchases at Main Street and Other Credit Facilities

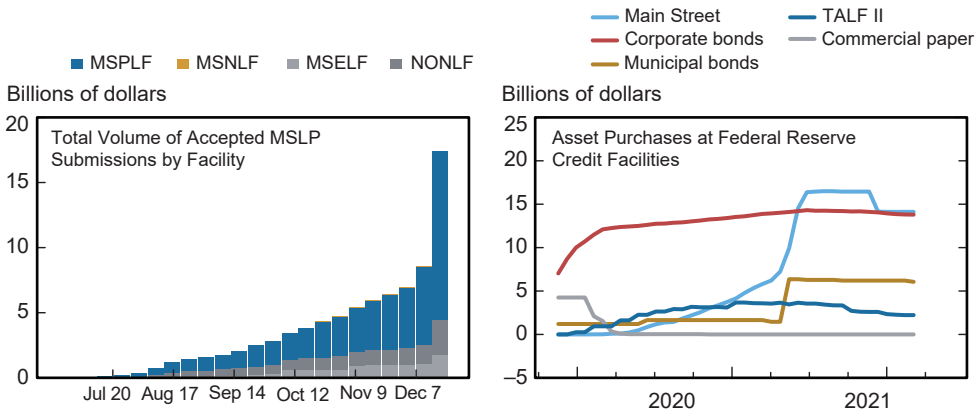

Sources: MSLP data; Federal Reserve, H.4.1 Statistical Release, “Factors Affecting Reserve Balances.”

Main Street loans also constituted a meaningful addition to the overall flow of credit during the program’s active phase. As shown by Bräuning and Paligorova (2021), the cumulative volume of Main Street lending was about 60 percent of the volume of term loans originated during the same time span by large banks (FR Y-14Q filers) to borrowers of similar size and leverage (that is, borrowers with less than \$5 billion in annual revenues and leverage below six times EBITDA). Moreover, when considering smaller firms (those with less than \$50 million in EBITDA), Main Street lending substantially exceeded the supply of credit by the largest banks to borrowers of comparable size. When also imposing the six times EBITDA leverage limit in the Y-14Q data, Main Street lending was about twice as large as lending by the largest banks to comparable borrowers.²¹

At the same time, Main Street volumes were low when compared with the surge in C&I lending from credit line drawdowns in March 2020, or when compared with the maximum capacity of the program, as noted. In part, this reflected much weaker loan demand after the launch of the program in July 2020, as discussed in Section 2. Reach was likely also constrained by certain program features, a theme we return to below.

Table 2 summarizes the Main Street purchases by loan type and size. The bottom line shows that priority loans and new loans turned out to be more in demand than expanded loans. The 1,173 priority loans accounted for nearly three-quarters (74 percent) of total volume while the 616 new loans made up 15.5 percent. The 26 expanded loans accounted for the balance. As stated above, expanded loans entailed modifying existing credit agreements, which may have reduced demand for these loans. The Nonprofit New Loan Facility (NONLF) was very small both in the number and volume of loans, and the Nonprofit Extended Loan Facility (NOELF) was not used at all.

Table 3 summarizes the size distribution of loans made across the different facilities. Most loans were in the range of \$1 million to \$50 million, with an average of \$9.5 million and median of about \$4 million. In comparison, the average PPP loan was just \$101,000, suggesting that Main Street succeeded in targeting firms that were too large for the PPP but too small to access the bond market. At the program’s inception, the minimum loan size was

TABLE 2

Loan Volume (in Millions) and Count, by Loan Type and Size

Loan Size (Dollars)	Expanded Loans		New Loans		Priority Loans		Nonprofit Loans		Total	
	Volume	Count	Volume	Count	Volume	Count	Volume	Count	Volume	Count
≤250K			4	19	0.3	2	0.2	1	5	22
250-500K			26	68	12	28	0.9	2	39	98
500K-1M			95	118	65	82	1	2	161	202
1-10M	20	2	1,221	350	3,034	671	40	10	4,314	1,033
10-35M	238	10	1,349	61	5,809	304			7,396	375
35-50M	81	2			3,997	86			4,078	88
>50M	1,466	12			0	0			1,466	12
All loans	1,805	26	2,695	616	12,917	1,173	42	15	17,459	1,830

Source: Authors' calculation using MSLP and Call Reports data.

Note: Entries may not sum to total due to rounding.

TABLE 3

Main Street Loan Size Distribution, by Type

	Loan Size (in Millions)							
	Mean	Min	p10	p25	p50	p75	p90	Max
Expanded loans	69.4	10.0	11.0	22.0	40.5	90.0	148.0	300.0
New loans	4.4	0.1	0.4	0.8	2.0	4.5	10.0	35.0
Priority loans	11.0	0.1	1.1	2.4	6.0	14.8	30.0	50.0
Nonprofit loans	2.8	0.2	0.4	0.6	2.5	5.0	5.0	8.5
All facilities	9.5	0.1	0.7	1.5	4.0	10.6	25.0	300.0

Source: Authors' calculation using MSLP and Call Reports data.

\$250,000, but this threshold was lowered to \$100,000 for certain facilities on October 30 to better target support for small businesses. There were, however, only 22 loans smaller than or equal to \$250,000 at the end of the program. On the other end of the size distribution, there were a small number of loans made through the MSELF that were larger than \$50 million, together totaling \$1.5 billion—almost 10 percent of the overall Main Street volume. The largest loan made through this facility was \$300 million, the maximum loan size for expanded loans.

4.2 Borrower Characteristics

Altogether, 2,453 borrowers and co-borrowers took out a total of 1,830 loans.²² Table 4 profiles borrowers in terms of revenue, leverage, and assets as of 2019. The average revenue was

TABLE 4

Main Street Borrower Financial Characteristics

Metric	Mean	p25	p50	p75	Count
2019 Revenue (millions of dollars)	33.9	3.9	11.5	31.8	1,830
2019 Leverage (multiple of EBITDA)	1.1	0.0	0.6	1.8	1,830
Assets (millions of dollars)	26.2	1.5	6.3	21.6	1,830

Source: Authors' calculation using MSLP and Call Reports data.

\$33.9 million. The pre-pandemic levels of leverage were relatively low, with the average being just above one multiple of EBITDA. Borrowers' average asset size was \$26.2 million, consistent with the program's target of reaching medium-sized firms. Moreover, Main Street borrowers saw an average revenue decline of about \$7 million during the first two quarters of the pandemic, relative to their most recent pre-pandemic reporting in 2019. This illustrates that Main Street helped many borrowers that were hit hard by the pandemic but were solvent and viable businesses before the crisis started.

Main Street supported borrowers across a diverse range of industries (see Table 5). The top industries by loan volume were accommodation and food services; manufacturing; real estate and rental and leasing; mining, quarrying, and oil and gas extraction; and transportation and warehousing. By loan count, professional services was second to accommodation and food services, with manufacturing third and construction firms fourth. The least active industries in terms of both loan volume and counts were utilities, agriculture and forestry, and public administration.

The geographic reach of Main Street borrowers was also wide, with borrowers in nearly every state. The most active states by volume were Texas (\$3.1 billion), Florida (\$2.1 billion), California (\$2.1 billion), New York (\$700 million), and Missouri (\$700 million).²³ It is also useful to look at loan volumes relative to state GDP, as shown in Exhibit 1. Using this normalization, the top five states were Oklahoma, Arkansas, Missouri, Florida, and Texas.

Chart 5 provides further evidence suggesting that Main Street reached borrowers in industries and regions that were hit hard by the pandemic. The left panel shows that 72 percent of total Main Street lending went to COVID-affected industries.²⁴ The right panel shows that state-level Main Street borrowing in any month was positively correlated with the previous month's COVID-19 positivity rate in the borrower's state, controlling for state GDP per capita and time fixed effects.²⁵

4.3 Lender Characteristics

A total of 643 lenders successfully registered to participate in the Main Street Program, all but 27 of which were commercial banks. That represents about 1 in 7 of all FDIC-insured banks, a

TABLE 5

Main Street Borrowers by Industry

Industry	Volume (Millions of Dollars)	Percentage of Volume	Loan Count	Percentage of Loan Count
Accommodation and food services	2,182	12.5	268	14.6
Manufacturing	1,711	9.8	169	9.2
Real estate	1,659	9.5	141	7.7
Mining, oil and gas extraction	1,468	8.4	90	4.9
Transportation	1,397	8.0	107	5.8
Arts and recreation	1,242	7.1	117	6.4
Professional services	1,159	6.6	171	9.3
Construction	1,132	6.5	166	9.1
Wholesale trade	961	5.5	112	6.1
Information	907	5.2	92	5.0
Health and social care	837	4.8	71	3.9
Administrative support services	796	4.6	60	3.3
Retail trade	618	3.5	92	5.0
Other services	352	2.0	64	3.5
Educational services	307	1.8	26	1.4
Finance and insurance	237	1.4	49	2.7
Management	230	1.3	18	1.0
Utilities	186	1.1	8	0.4
Agriculture and forestry	76	0.4	8	0.4
Public administration	1	0.01	1	0.1
Total	17,459	100	1,830	100

Source: Authors' calculation using MSLP and Call Reports data.

Note: Entries may not sum to total due to rounding.

meaningful share for a six-month program. About half of these banks (316) sold loans to Main Street, while 327 did not actively participate despite being registered.

Chart 6 shows that Main Street lending activity was dominated by banks that were small to medium-sized in terms of total assets. Most active banks were in the \$250 million to \$750 million range or the \$1 billion to \$50 billion size range (left panel). The share of registered lenders increases with each size group (right panel, blue and gold portions of the bars). Very small banks (less than \$250 million in assets) were underrepresented.

Chart 7 shows lending intensity by bank asset size. Banks in the \$1 billion to \$10 billion asset-size category account for 34 percent of the total number of loans and 34 percent of the total volume of loans; banks in the \$10 billion to \$50 billion asset-size group account for 29 percent of loans and 21 percent of volume; and banks in the \$250 million to \$500 million and \$500 million to \$750 million size groups together account for 17 percent of loans and volume. While the volume of Main Street loans issued by banks with assets of \$1 billion or

EXHIBIT 1
Main Street Loan Volume Divided by State GDP

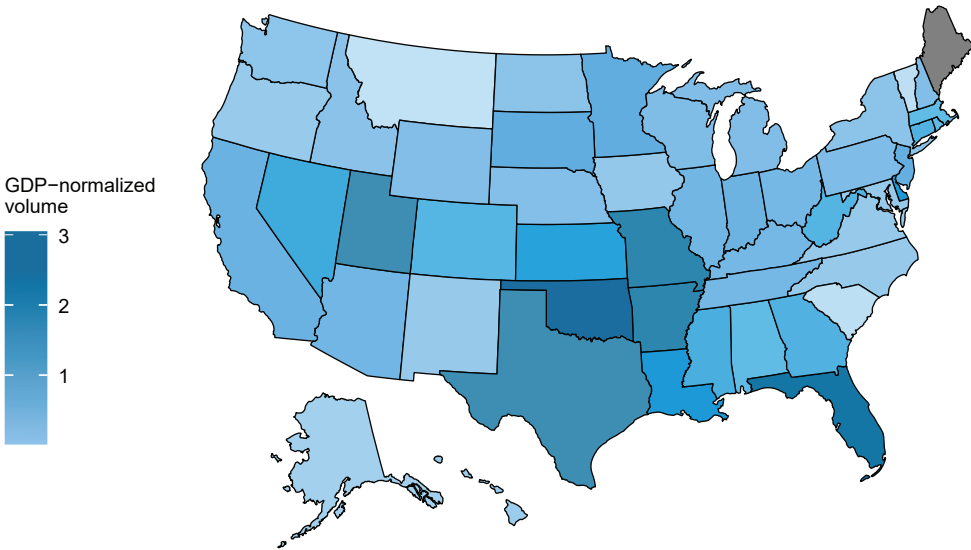

Source: MSLP data.

more account for 55 percent of the total Main Street lending, these banks’ total assets represent 95 percent of the U.S. banking system’s assets.

Most banks active in the program sold just one or two loan participations (Chart 8). The banks that sold multiple participations tended to sell fewer than 10, though several lenders sold more than 20, and there were a few extremely active participants that sold more than 30 loans, suggesting once a lender had experience with the loan process, scale was possible.

Registered banks tended to have a higher concentration in C&I lending than nonregistered banks, regardless of their size. The left panel of Chart 9 shows that differences in C&I concentration between registered and nonregistered lenders are significant for any size bin. Moreover, the panel on the right shows that the intensive margin is positively correlated with the concentration. Banks that were more active in the Main Street program tended to have a higher concentration in C&I lending measured before the pandemic.

4.4 Program Features and Take-up

Many of Main Street’s features were chosen to balance the tradeoff between the reach of the program and the riskiness of the loans made to borrowers. This section takes a very preliminary look at how the program performed in terms of striking that balance—preliminary since the ultimate credit performance of the Main Street loans is not yet known.

Regarding determinants of reach, Table 6 shows that loan size was more often limited by the leverage cap than by the nominal maximum loan size. About 30 percent of borrowers were within 5 percent of the relevant leverage limit. In addition, on the extensive margin, the

CHART 5

Main Street Credit Reached Highly Affected Industries and States

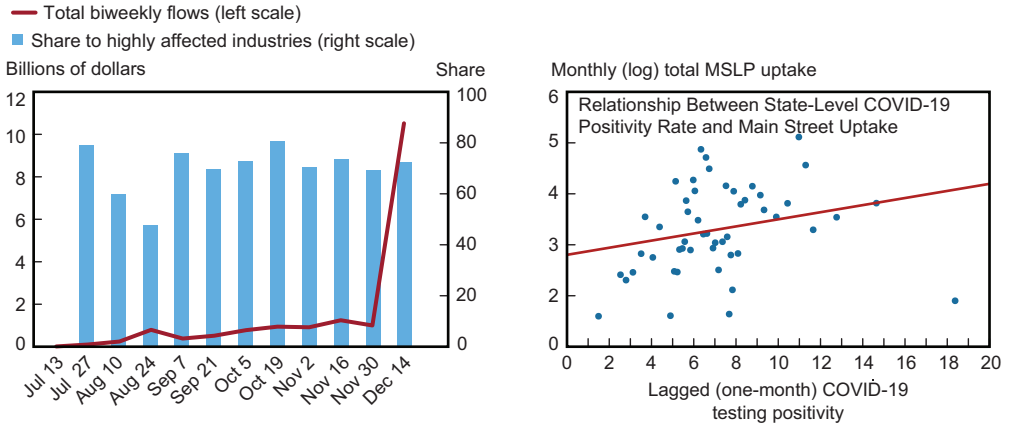

Sources: Authors' calculation using MSLP data (left panel). Authors' calculation using MSLP data, Bureau of Economic Analysis, and Opportunity Insights data (right panel).

Notes: COVID-affected industries include entertainment and recreation, oil and gas, real estate, retail, and transportation services. Data in right panel are orthogonalized with respect to calendar month and state GDP per capita. Each dot represents a U.S. state.

CHART 6

Lenders Size Distribution by Registration Status

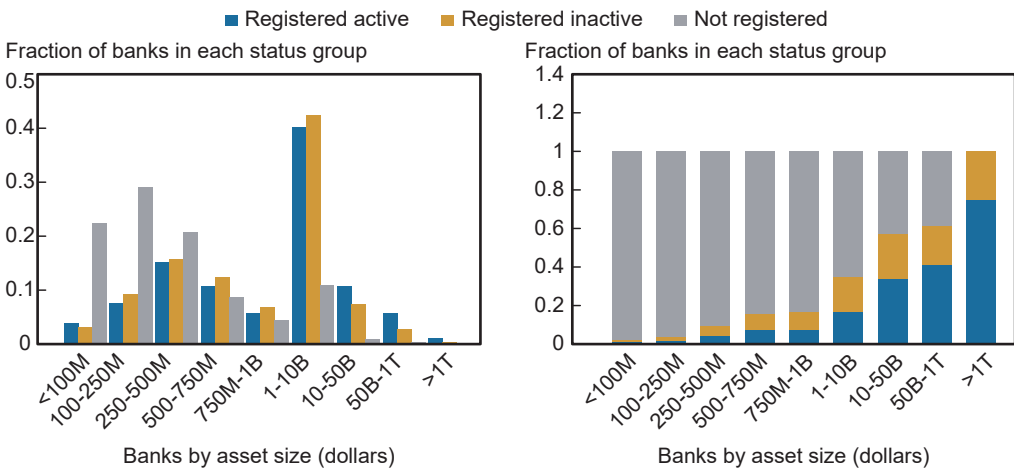

Source: Authors' calculation using MSLP and Call Reports data.

Notes: Registered active banks are those with accepted special-purpose vehicle (SPV) loans. Registered inactive banks have either zero or rejected submissions to the SPV.

CHART 7
Main Street Lending Activity by Lender Size

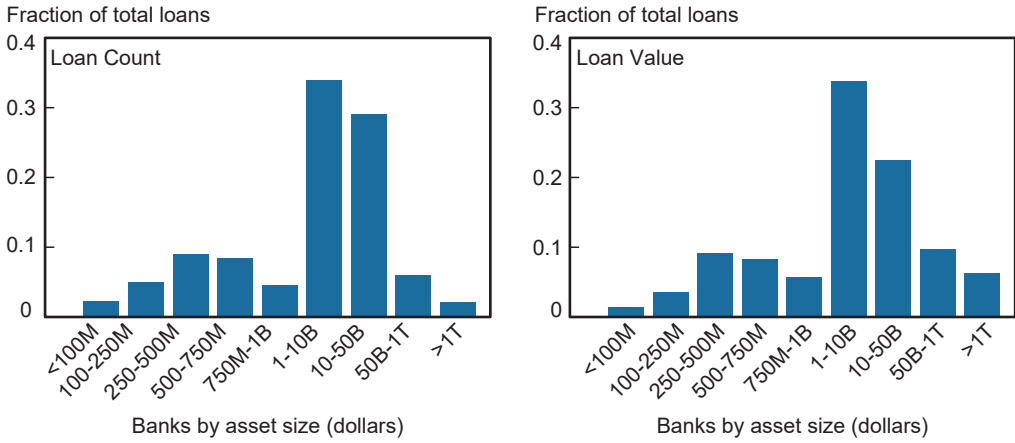

Source: Authors' calculation using MSLP and Call Reports data.

CHART 8
Number of Loans Sold per Bank

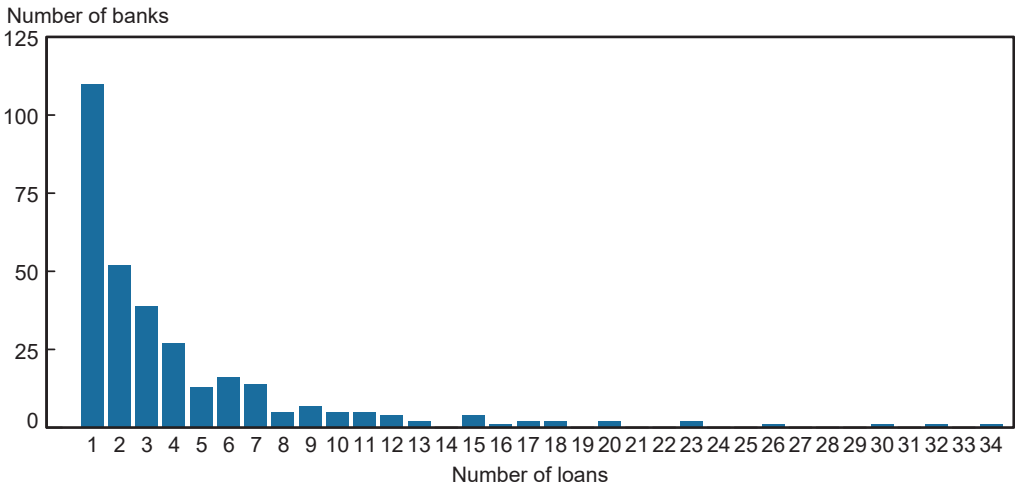

Source: MSLP data.

Note: Selected banks were excluded for legibility.

leverage limits also completely excluded some potential borrowers with high leverage. Conversely, less than 4 percent of borrowers were within 5 percent of the loan size upper limit, also across all three facilities.

Although it is still too early to fully assess the riskiness of loans made through the Main Street program, it is nonetheless informative to compare the characteristics of Main Street

CHART 9
C&I Loan Concentration by Lender Registration and Activity

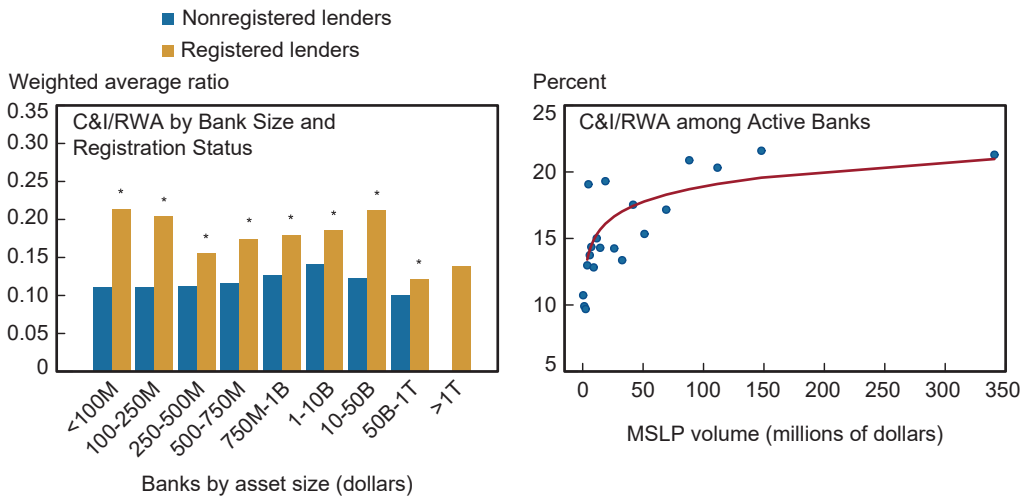

Source: Authors' calculation using MSLP and Call Reports data.

Notes: Left panel: Ratios as of 2019:Q4 are weighted by risk-weighted assets (RWA). * denotes statistically significant difference in mean of registered versus unregistered lenders, by asset size, at the 95 percent confidence level. Right panel: Selected banks were excluded for legibility.

loans with those of a set of similar loans made outside the program. For loans made outside the program, we use loan-level data from the Federal Reserve's Y-14Q (Y-14) data covering the largest banks that were subject to stress tests over the same time period as the Main Street program.²⁶

Chart 10 (left panel) shows that Main Street borrowers tended to be smaller and more leveraged than a large bank's typical C&I borrower.²⁷ About half of Main Street loans went to firms with total assets in the range of \$5 million to \$100 million, very comparable to the fraction of large bank C&I lending to firms of that size. However, 25 percent of large bank C&I loan volume went to borrowers with total assets exceeding \$100 million, whereas Main Street borrowers of that size represent only 4.3 percent of the loan volume. The right panel shows that Main Street borrowers also tended to be more leveraged. Almost half of Y-14 borrowers had leverage between zero times and two times EBITDA. In contrast, almost 90 percent of Main Street loans went to borrowers with leverage between two times and six times EBITDA. While most large-bank borrowers tended to have leverage within program limits, the fraction with leverage exceeding those limits (that is, exceeding six times EBITDA, or with zero or negative EBITDA) was still significant (16.9 percent).

For a deeper analysis, we name-matched Main Street borrowers to those also present in the Y-14 to come up with a set of 149 borrowers that have a loan both in the Y-14 (as of the fourth quarter of 2019) and through the Main Street program. This matched dataset, though small, provides a more detailed understanding of the borrower risk profile and terms for loans made through Main Street compared with loans made outside of Main Street but to the same borrower.

TABLE 6

Share of Loans by Distance from the Leverage and (Nominal) Loan Size Limits

Facility	Leverage Limit			Loan Size Limit		
	At Limit	Within 1%	Within 5%	At Limit	Within 1%	Within 5%
Expanded loans	3.8	11.5	26.9	3.8	3.8	3.8
New loans	5.7	21.6	31.7	2.1	2.1	2.1
Priority loans	5.9	18.6	29.2	3.8	4.1	4.4
Nonprofit loans	0.0	0.0	0.0	0.0	0.0	0.0
All facilities	5.8	19.5	30.0	3.2	3.4	3.6

Source: Authors' calculation using MSLP and Call Reports data.

Chart 11 compares internal bank ratings for our matched sample of Main Street borrowers that are also found in the Y-14 (green bars) and borrowers from the Y-14 more generally (blue bars).²⁸ The left panel shows that the distribution of ratings for the two groups was roughly similar before the pandemic. The panel on the right shows that during the pandemic, the distribution of ratings for Main Street borrowers was considerably skewed toward worse credit quality relative to Y-14 borrowers more generally. Moreover, Chart 12 shows the evolution of ratings after origination for Main Street-matched borrowers compared with the rest of Y-14 borrowers. Main Street borrowers show a significantly faster deterioration of credit quality according to the banks' own internal rating systems. As a caveat, note that the internal rating given by the Y-14 bank may not coincide with the Main Street lender's rating of that same borrower.

Because the Y-14 has data on loan spreads, we can compare the pricing of loans made outside Main Street to the uniform pricing (LIBOR + 300) on all Main Street loans. Table 7 shows (unsurprisingly) that smaller, more leveraged Y-14 firms paid higher spreads on average prior to the onset of the pandemic, with an interquartile range of 150 to 255 basis points over LIBOR. Spreads were slightly higher in the second quarter of 2020, when restrictive health policy measures were in effect. Before the pandemic, 13.5 percent of the bank loans paid a spread over LIBOR higher than 300 basis points, rising to 16.5 percent in the second quarter of 2020. This rise occurred despite tighter (non-price) lending standards and the shift to safer borrowers by banks during the spring and summer, as noted previously. Most Y-14 borrowers were able to secure lending below 300 basis points even during the crisis, which may explain the initial slow pace of uptake in the Main Street facilities by companies that already had banking relationships with large financial institutions (Y-14 lenders). However, the lack of comparable data from smaller lenders that do not file Y-14 data and the lack of data indicating the number of loan requests denied by lenders make it difficult to draw conclusions about the impact of Main Street pricing on program demand.

The profile so far suggests that Main Street borrowers were, on average, riskier than comparable Y-14 borrowers. This is not entirely surprising, as higher-quality borrowers were probably able to secure credit at a lower rate through their already established relationship with a Y-14 lender. These conclusions also need to be taken with caution, as the matched sample represents a small fraction of all Main Street borrowers and a tiny fraction of Y-14 borrowers overall. The

CHART 10
Main Street and 14Q Borrower Size and Leverage

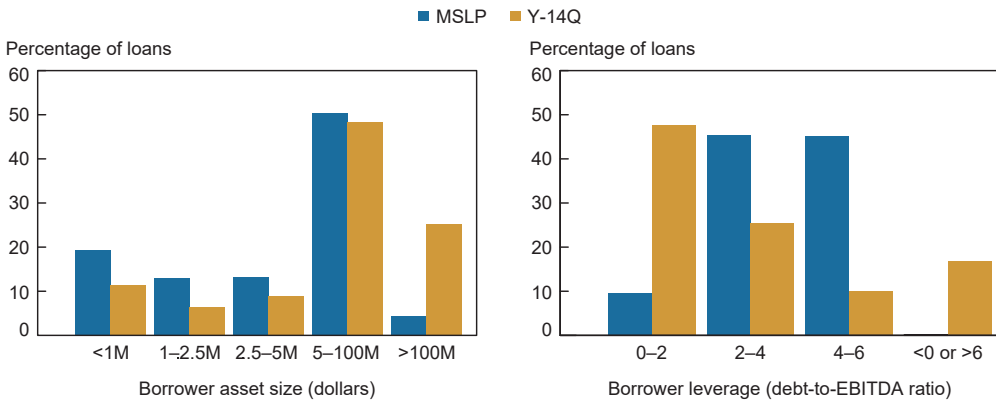

Source: Authors' calculation using MSLP and FR Y-14Q (H.1) data.

CHART 11
Ratings of MSLP Borrowers in the Y-14 and All Y-14 Borrowers

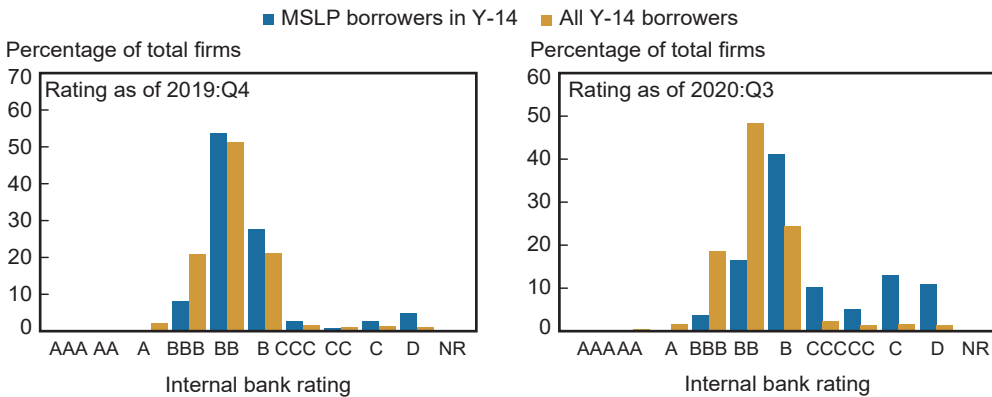

Source: Authors' calculation using MSLP and FR Y-14Q (H.1) data .

differences noted may also reflect differences between the types of borrowers at small and medium-sized banks (that were most active in Main Street) relative to the types of borrowers at the large banks covered in the Y-14.

In sum, Main Street borrowers historically paid higher spreads for bank loans and experienced more severe rating downgrades than a comparable reference group (Y-14). Additionally, the fact that riskier borrowers were able to obtain credit from Main Street facilities can be interpreted as consistent with program objectives, since the goal of Main Street was to share risk with banks during the severe economic downturn caused by the pandemic. In the initial months, borrowing was driven by more highly levered firms, but the scope of lending increased over time to reach less levered firms. However, leverage ended up being the binding constraint for most of the

CHART 12

Changes in Credit Risk Ratings for Main Street Borrowers in the Y-14 and All Y-14 Borrowers

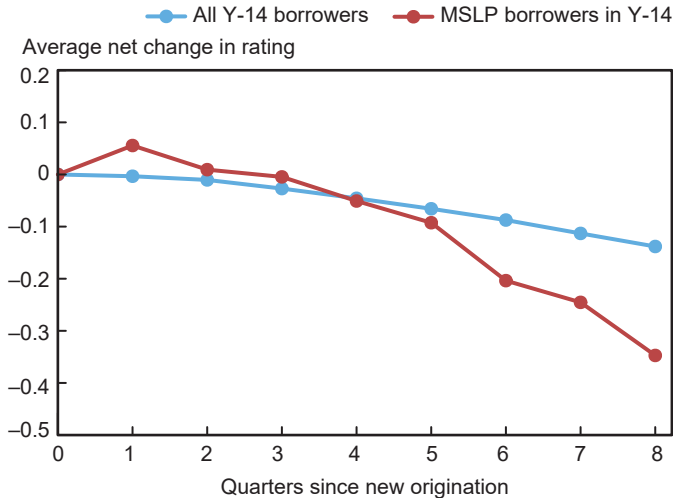

Source: Authors' calculation using MSLP and FR Y-14Q (H.1) data.

borrowers, and this was true across all industries. Finally, the program reached industries and geographies that were most affected by the economic effects of the pandemic.

4.5 Capital Channel

Main Street loans allowed banks to preserve capital buffers, since banks are required to maintain capital against only their retained (5 percent) share. An implication is that, apart from risk-sharing, Main Street might have also supported lending through a capital channel whereby banks benefit from originating loans but do not pay the full capital cost of carrying those loans on their balance sheets.

Chart 13 shows that registered banks tended to have lower capital ratios than nonregistered banks across all but the smallest size category. These differences are statistically significant for all but the smallest size groups. Moreover, there is a significant difference in capital ratios between banks that actively participated and those that did not register or registered but were not active. To investigate the capital channel further, we calculated the aggregate reduction in required capital facilitated by the Main Street program for all active banks and found it to be a modest 0.24 percent.²⁹ The median capital savings across banks is 1.1 percent, the average is 10.2 percent (reflecting outliers), and the interquartile range is 0.23 to 6.8 percent. Looking across bank size groups, the largest percentage reductions in required capital were at smaller banks. For example, the 43 active banks in the \$100 million to \$250 million size group save 53 percent on average, with a median saving of 12.8 percent. For the largest banks (more than \$50 billion), the reductions are insignificant.

TABLE 7
Loan Spreads Relative to LIBOR on Newly Originated Y-14 Term Loans, by Date and Size-Eligible Borrower Characteristics

	2019:Q4					2020:Q2						
	Mean	Median	p25	p75	Percent of Total Loans >300 BPS	Percent of Total Loans >300 BPS	Mean	Median	p25	p75	Percent of Total Loans >300 BPS	Percent of Total Volume >300 BPS
<i>Panel A: Total Assets</i>												
Less than \$1M	2.47	2.25	1.75	2.78	17.4%	10.5%	2.09	2.14	1.27	2.63	4.3%	3.4%
Between \$1M and \$2.5M	2.38	2.20	1.75	2.75	11.3%	5.1%	2.75	2.30	2.01	2.93	8.3%	1.3%
Between \$2.5M and \$5M	2.43	2.27	1.75	2.86	14.1%	15.0%	2.62	2.45	2.00	3.00	23.1%	17.5%
Between \$5M and \$100M	2.26	2.00	1.64	2.75	15.2%	18.8%	2.44	2.20	1.50	2.75	18.2%	26.6%
Greater than \$100M	1.96	1.63	1.36	2.25	9.5%	11.2%	2.22	1.85	1.50	2.50	15.8%	14.3%
Total (Size of Assets)	2.21	2.00	1.50	2.55	13.5%	13.8%	2.35	2.00	1.58	2.75	16.5%	16.4%
<i>Panel B: Leverage</i>												
Between 0 and 2	2.16	2.00	1.50	2.60	12.4%	11.3%	2.15	2.00	1.52	2.50	10.8%	13.0%
Between 2 and 4	2.11	1.97	1.50	2.50	10.5%	15.1%	2.48	2.25	1.83	2.98	13.5%	19.0%
Between 4 and 6	2.29	2.25	1.59	2.50	13.6%	10.2%	2.20	1.75	1.50	2.50	17.9%	5.6%
Less than 0 or greater than 6	2.38	2.00	1.60	2.75	19.7%	17.7%	2.57	1.88	1.25	3.50	31.6%	31.2%
Total (Leverage)	2.20	2.00	1.50	2.54	13.4%	13.4%	2.32	2.00	1.50	2.75	16.5%	16.9%
Total (Aggregate)	2.21	2.00	1.50	2.57	13.8%	14.2%	2.30	2.00	1.56	2.61	15.6%	15.9%

Source: Authors' calculation using MSLP and Call Reports data.

Note: Size-eligible borrowers are firms with annual revenue up to \$5 billion.

CHART 13

Capital Ratios by Registration Status and Lender Size

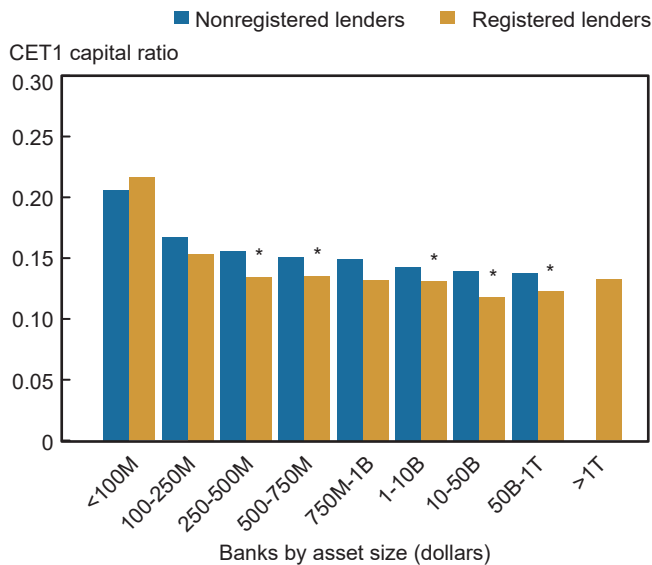

Source: Authors' calculation using MSLP and Call Reports data.

Notes: CET1 is common equity tier 1. Ratios are weighted by riskweighted assets. * denotes statistically significant difference in mean of registered versus unregistered lenders, by asset size, at the 95 percent confidence level.

All told, the evidence presented here supports the capital channel. For the largest banks, the capital channel may have provided an incentive to actively participate, but, in practice, capital savings were likely modest. In contrast, the capital savings for smaller banks that used the program more intensely were estimated to be more substantial. Minoiu et al. (2021) also find evidence in favor of the capital channel using a more sophisticated multivariate regression framework.

5. LESSONS LEARNED AND CONCLUSIONS

With most Main Street loans still outstanding, it is too early to discuss definitive lessons. In particular, the credit performance of the loans is not yet known. However, now that Main Street has stopped purchasing loan participations, we attempt to outline a few conclusions and preliminary lessons learned.

The program helped many borrowers hit hard by the pandemic.

Main Street facilitated more than 1,800 loans to businesses across the nation, representing a wide range of industries. Volume, at about \$17 billion in total, was modest relative to the maximum size of the program, but it represented a meaningful addition to the flow of bank credit while the program was in operation, leading Main Street to become the largest credit

purchase facility operated by the Federal Reserve.³⁰ Moreover, many Main Street borrowers were hit hard by the pandemic, and lenders indicated that they made loans they would not otherwise have made, in line with the goals of the program.

Speed is essential, but setting up a novel loan purchase program takes months.

Loan demand was most pronounced in the spring of 2020, before Main Street was operational. Looking at the experience across PPP and similar programs abroad, about half to three-fourths of the uptake occurred by the end of the second quarter of 2020.³¹ This pattern suggests that, in a crisis, speed of execution may need to be prioritized to ensure that support is available when needed. With Main Street, about four months passed between its announcement and the first loan purchase, longer than other emergency lending programs of the Federal Reserve (Morgan and Clampitt 2021).

The length of the rollout time reflected the unprecedented nature of the program: The Federal Reserve had not operated a credit program for small and medium-sized businesses since the 1940s, and it had never deployed a program to purchase loan participations. So there was no blueprint, as there was for most other emergency programs rolled out by the Federal Reserve in response to the pandemic. In addition, the program was operationally complex, reflecting the bespoke nature of the C&I loan market for small and medium-sized businesses, and necessitated development of many legal agreements and roughly 100 pages of FAQs in coordination with the Treasury. The program also required the development of information-technology, credit-risk, and accounting systems to execute the purchase of loan participations, all of which took time to build. Even with this experience, any future loan participation program (or direct lending program) would likely require more time to operationalize than other market-based emergency lending programs. Finally, policymakers made several adjustments along the way to refine the program in response to feedback and evolving conditions. These changes meant lenders had to incorporate new aspects of the program in their origination process, which created some delays in underwriting. The changes also introduced new operational elements that required time to incorporate.

The program's structure and complexity limited its attractiveness to lenders and borrowers.

The program's participation structure, which was designed to be consistent with Federal Reserve authorities and to give banks an incentive to undertake a degree of risk-screening through banks' risk retention, likely limited lender appetite to underwrite loans to riskier borrowers, compared with, for example, a full loan guarantee program. Most lenders entered the pandemic with stronger balance sheets and more lending capacity than in past economic downturns. This cushion prevented a more severe reduction in loan supply than might otherwise have occurred and reduced demand for programs without loan forgiveness.³² Additionally, the complexity of the program likely made origination and servicing costs large, and hence the lender's return may have been attractive only for larger loans, safer borrowers, or at high volumes. Indeed, many banks indicated that they preferred to lend outside the program when possible to avoid its administrative and operational complexities, including the program's certifications and covenants as well as perceived uncertainty about partnering with the government in the event of future workout situations. Further, lenders cited the reporting requirements over the life of the loan, necessary to track credit quality, as a significant deterrent to smaller borrowers not accustomed to providing regular quarterly financial statements as part of a lending arrangement. Finally, for

lenders who did participate, the program's complexity necessitated an investment in new processes that delayed underwriting. The surge at the close of the program provides some evidence that the program pipeline among participating lenders had been building up over time.

Binding leverage limits, relatively inflexible loan terms, security and priority requirements, and limits on refinancing all limited risk, but did so at the expense of the program's reach.

Leverage limits were a binding constraint on loan size for many borrowers and likely excluded some vulnerable borrowers with an ability to repay, such as those with higher leverage levels that traditionally relied on asset-based borrowing. This was particularly true for the nonprofit facilities, where potential borrowers, which operate with low earnings in normal times, were required to meet a large number of financial and operational thresholds to be eligible for the program. In addition, the loan terms offered little flexibility, including no allowance for revolving credit facilities. Allowing some flexibility on the loan interest rate might have created room for more risk-based pricing—that is, loan rates that reflected lenders' assessment of borrowers' risk.³³ Credit programs in the United Kingdom and France allowed for more flexibility on rates than Main Street. At the same time, such flexibility would have increased complexity further, and high interest rates may not have been viewed as consistent with the program's goals. The requirement at some Main Street facilities that loans be senior to or *pari passu* with the borrower's other loans may also have discouraged lenders from expanding credit to their existing borrowers. Finally, lenders and borrowers repeatedly asked for greater flexibility to refinance existing loans through the program, particularly those that were maturing in the near term. While refinancing limits were important in reducing the risk that lenders would simply shift their existing exposure to risky borrowers to Main Street, additional options for lenders to roll over maturing debt would likely have fostered broader program reach.

APPENDIX: INCOME AND LOSS PROJECTIONS DURING THE DESIGN PHASE

To ensure compliance with the requirements of Section 13(3) of the Federal Reserve Act, the Federal Reserve had to assess potential gains and losses from Main Street's operations. These projections were akin to a stress test, starting with the development of several credit risk scenarios. At the time the program was being designed, still early in the pandemic, the economic outlook was extremely uncertain. It was impossible to know how long the economic disruptions would last or how deep the economic damage would be. Against that background, staff considered a range of loan-loss scenarios. As in a stress test, some of the scenarios were intended to be fairly conservative—severe yet plausible.

One approach was to consider the worst cumulative gross charge-off rates on bank C&I loans that had been historically observed over any four- or five-year period. This resulted in elevated projected loss rates.³⁴ Still, in light of the unprecedentedly severe nature of the downturn, Main Street's goal of helping borrowers hit hard by the pandemic, and the risk of adverse selection in the program's portfolio, it seemed prudent to consider more severe scenarios with loss rates two to three times the (historically) worst case.

A second approach relied on results from severely adverse scenarios in the Federal Reserve's stress tests of large banks in 2018 and 2019.³⁵ Staff used the projected loss rates on unsecured and non-investment-grade loans, which seemed consistent with Main Street's targeting of small and medium-sized business borrowers, for which an investment-grade rating is less common than for large corporate borrowers. In addition, staff also considered the 75th percentile of loan losses across all unsecured, non-investment-grade business loans, which suggested substantially higher loss rates, in the range of 10 to 20 percent.³⁶

A third approach employed forecasts of default rates by a major credit rating agency for the institutional leveraged loan market. These forecasts incorporated early estimates of the effects of COVID-19–related disruptions on credit performance. Leveraged lending is generally riskier than the broad class of lending eligible for Main Street, so this approach was also plausibly conservative. After some adjustments, this resulted in a scenario with a 14 percent default rate over the term of the loans. To obtain loan-loss rates from default rates, assumptions for the loss-given-default (LGD) were needed. Given the likelihood of stressed economic conditions, at least for the coming months or years, the projections assumed relatively high LGDs, in the 60 to 90 percent range.³⁷ Again, multiples ultimately up to two times the default rates were also considered for robustness (holding LGDs constant).

With these credit scenarios in hand, staff was able to project gains and losses for Main Street under alternative design choices for the loan terms, fees, and risk-sharing arrangement. Defaults were assumed to be concentrated at the end of year two of the loan, when the first principal repayment becomes due. The less adverse scenarios, including the worst historically observed C&I loan charge-off rate and the stress testing portfolio-average losses, were projected to result in net gains for the Main Street SPV, with interest income outweighing credit losses. However, the more adverse scenarios were projected to result in net losses to the Main Street SPV and therefore to the Treasury's equity investment.

APPENDIX (CONTINUED)

These projections guided the decision to cap SPV “leverage” at 8-to-1. Given the Treasury’s planned \$75 billion equity investment, the leverage cap dictated a maximum program size of \$600 billion. With that leverage, even under the more adverse scenarios, the Federal Reserve was projected to incur zero losses.

NOTES

Acknowledgments: The authors thank, without implicating, William Bassett, Steffanie Brady, Jie Chen, Julian Di Giovanni, Michael Kiley, Andreas Lehnert, Kelley O'Mara, Joe Peek, Mark Van Der Weide, and an anonymous referee for valuable input. Jake Faber, Frankie Lin, and Mary Zhang provided expert research assistance.

¹ See “Funding, Credit, Liquidity, and Loan Facilities,” <https://www.federalreserve.gov/funding-credit-liquidity-and-loan-facilities.htm>. The comparison excludes liquidity facilities, some of which had larger peak outstanding amounts, for example the Paycheck Protection Program Liquidity Facility, the Money Market Mutual Fund Liquidity Facility, and the Primary Dealer Credit Facility.

² We use “missing middle” as short-hand for medium-sized firms that depend on banks (or other intermediaries) for credit and that are too large for PPP loans. Note, though, that there is no standard cross-industry definition of “small,” “medium-sized,” or “mid-sized,” and the definitions in our analysis vary somewhat according to the data we cover. The cutoffs for Main Street are discussed in the next section.

³ Based on 2018 Census data, firms with between 500 and 5,000 employees employ about 23 million people. Most of these firms are private and cannot access public debt markets. Even among the publicly traded firms covered in the Compustat database, the smaller firms (which are still larger than most private firms) rely more on bank financing (Rauh and Sufi 2010). Calomiris, Himmelberg, and Wachtel (1995) find that only 20 percent of manufacturing firms in the Compustat database have a bond or a commercial paper rating.

⁴ The later phase of this lending surge also reflected PPP lending by banks.

⁵ Chodorow-Reich et al. (2020) find that this difference reflects the reality that smaller firms were less likely to have credit lines or faced stricter (pre-COVID) terms that limited their takedowns.

⁶ The SLOOS defines small firms as those with annual sales of less than \$50 million. Large and middle-market firms have sales greater than \$50 million.

⁷ See “Federal Reserve Announces Extensive New Measures to Support the Economy,” Federal Reserve Board press release, March 23, 2020, <https://www.federalreserve.gov/newsevents/pressreleases/monetary20200323b.htm>. Note that the Board announced its intention to establish Main Street before the passage of the Coronavirus Aid, Relief, and Economic Security Act (CARES Act), and Congress, in the CARES Act, expressly gave the Board wide discretion in designing a program to “support lending to small and mid-sized businesses on such terms and conditions as the Board may set consistent with Section 13(3).” 15 U.S.C. § 9042(c)(3)(D)(ii).

⁸ 12 U.S.C. § 343(3).

⁹ See 15 U.S.C. § 9042, 9054.

¹⁰ Lack of regulatory capital or lack of funding at banks were not considered the primary constraints on lending at the time. Had either been, a very different type of program might have been deemed appropriate, such as a funding-for-lending initiative. However, these factors did not appear to be as important as heightened risk aversion. Although more bank capital, or a greater distance from regulatory capital requirements, can generally help reduce banks’ risk aversion somewhat, it is far from clear that this could have overcome the extreme uncertainty encountered in 2020.

¹¹ As noted previously, there is no standard U.S. definition of “small or “medium-sized.”

¹² By using the SBA’s framework, the Board was able to quickly implement definitions that had been promulgated pursuant to notice-and-comment rulemaking, tested in bank-intermediated government lending, and elucidated through SBA guidance. Further, these definitions were familiar to many lenders and had been recently incorporated into provisions of the PPP established under the CARES Act.

¹³ Borrowers certified their eligibility for program loans through the Borrower Certifications and Covenants. The use of certifications for purposes of borrower compliance with program requirements has a foundation in the statutory text of both the Federal Reserve Act and the CARES Act. (12 U.S.C. § 343(3)(B)(ii); 15 U.S.C. § 9042(c)(3)(D)(ii), 9054(c)). In general, the Borrower Certifications require the borrowers to establish their own eligibility, although lenders had an obligation to conduct due diligence with respect to the borrower’s formation under law.

NOTES (CONTINUED)

¹⁴ The following organizations could be an eligible lender: a U.S. federally insured depository institution (including a bank, savings association, or credit union), a U.S. branch or agency of a foreign bank, a U.S. bank holding company, a U.S. savings and loan holding company, a U.S. intermediate holding company of a foreign banking organization, or a U.S. subsidiary of any of the foregoing. These entities all have existing supervisory relationships with the Federal Reserve or other federal regulators.

¹⁵ Lenders generally had to establish their eligibility at the time of their registration through Lender Registration Certifications and Covenants, while the Lender Transaction-Specific Certifications and Covenants primarily required lenders to establish that a particular loan was eligible for sale to the Main Street SPV.

¹⁶ MSNLF and MSPLF loans under \$250,000 were permitted to have an origination fee of up to 2 percent, while MSELF loans (which entailed a \$10 million minimum loan size) featured an origination fee of up to 75 basis points.

¹⁷ Analysis predicted that MSELF participation would generally still be attractive to the lender provided the loan expansion reduced the borrower's probability of default. This proviso was broadly in line with the program's goal of helping borrowers hit hard by the pandemic but otherwise in sound financial condition.

¹⁸ The terms for the nonprofit facilities can be found at <https://www.federalreserve.gov/newsevents/pressreleases/files/monetary20201229a4.pdf> and <https://www.federalreserve.gov/newsevents/pressreleases/files/monetary20201229a5.pdf>.

¹⁹ It is unclear whether the rush was a function only of the impending closure or whether it also reflected the time required by lenders to originate Main Street loans. Discussions with lenders active in the program indicated that familiarizing themselves and their clients with the legal and operational elements of the program required a considerable investment in time. Both factors likely contributed to a backloading of the loan participations, with by far the largest volumes occurring in the program's waning days.

²⁰ The announcements of the corporate credit and municipal facilities had significant real-time effects on prices, and thus yields, of existing corporate and municipal bonds. Because such bonds are actively traded in secondary markets, announcement effects can be observed. Notably, price impact was seen even outside the range of bonds that would later be purchased by the facilities. In contrast, there is no active secondary market for business loans of the type targeted by Main Street. Thus, there is no way to gauge the announcement effect of Main Street in a similar fashion.

²¹ The comparison is not perfect since loans with balances below \$1 million are not required to be reported in the FR Y-14Q schedule. In addition, very small firms are more likely to borrow from smaller banks. However, as Chodorow-Reich et al. (2020) show, FR Y-14Q loans represent 82 percent of the total C&I bank credit.

²² The number of borrowers exceeds the number of loans because some Main Street loans had multiple borrowers that, in most cases, consisted of subsidiaries of the same parent firm.

²³ Conversely, the U.S. Virgin Islands, Maine, Montana, and Vermont all had volumes totaling less than \$10 million.

²⁴ COVID-affected industries include entertainment and recreation, oil and gas, real estate, retail, and transportation services.

²⁵ We find similar results when we use other measures of economic slowdown, such as unemployment claims, and population mobility measures as shown by Bräuning, Fillat, and Wang (2021).

²⁶ Banks with \$100 billion or more in consolidated assets are required to submit these data. The Y-14 data contain extensive supervisory information about the borrowers and about the loans, allowing us to compare the distribution of lending to Main Street borrowers and the rest of Y-14 borrowers along several dimensions. Information on borrower and loan characteristics is limited in the Main Street data, but it is much more comprehensive in the Y-14.

²⁷ We consider only potentially eligible borrowers in the Y-14 data, for comparability. Hence, the largest firms, those with revenue greater than \$5 billion, are excluded from our comparison.

NOTES (CONTINUED)

²⁸ Regarding the risk profile, Main Street participants are (by design) too small to have access to market finance and therefore to be rated by rating agencies. However, Y-14 banks are required to disclose borrower-level internal ratings as well as the correspondence to a common scale for comparison purposes. In our matched sample of 149 borrowers, we find that 139 Main Street borrowers had loans outstanding with internal (bank) ratings in the third quarter of 2020.

²⁹ We compute the reduction in risk-weighted assets (RWA) as the volume of Main Street loans removed from the banks' balance sheets through the sale of participations (that is, 95 percent of their total Main Street volume). Because risk-based capital requirements are expressed as fractions of RWA, the percentage reduction in RWA also equals the percentage reduction in required capital (CET1, tier 1, and total).

³⁰ See Chart 4 and "Funding, Credit, Liquidity, and Loan Facilities," <https://www.federalreserve.gov/funding-credit-liquidity-and-loan-facilities.htm>. The comparison excludes liquidity facilities, some of which had larger peak outstanding amounts.

³¹ The U.K.'s Coronavirus Business Interruption Loan Scheme (CBILS) and Bounce Back Loan Scheme (BBLs), France's Prêt Garanti par l'État (PGE), and the U.S.'s Paycheck Protection Program saw, respectively, 48 percent, 63 percent, 76 percent, and 65 percent of their total uptake by the end of the second quarter of 2020. See, for CBILS, <https://www.gov.uk/government/collections/hm-treasury-coronavirus-covid-19-business-loan-scheme-statistics#Coronavirus-Business-Interruption-Loan-Scheme>; for BBLs, <https://www.gov.uk/government/collections/hm-treasury-coronavirus-covid-19-business-loan-scheme-statistics#Bounce-Back-Loan-Scheme>; for PGE, <https://www.data.gouv.fr/fr/datasets/donnees-relatives-aux-prets-garantis-par-letat-dans-le-cadre-de-lepidemie-de-covid-19/> and for PPP, <https://www.sba.gov/funding-programs/loans/covid-19-relief-options/paycheck-protection-program/ppp-data>.

³² In a special Senior Loan Officer Opinion Survey on Main Street, a vast majority of nonregistered banks cited their ability to address the credit needs of Main Street-sized borrowers without participating in the program as an important or very important reason for not registering. See <https://www.federalreserve.gov/data/sloos/sloos-202009.htm>

³³ English and Liang (2020) have argued for more flexibility in Main Street's loan terms, including their interest rates and banks' risk retention share.

³⁴ Maximum cumulative gross charge-off rates amounted to 7.4 percent for a four-year period (2007:Q2 through 2011:Q1) and 8.7 percent for a five-year period (2006:Q3 through 2011:Q2). These rates were calculated using FFIEC Call Reports, where the relevant data are available from 1985 onward. Gross rates, which exclude recoveries, were used for robustness.

³⁵ From each of these stress tests, staff used the portfolio-average loss rate on unsecured, non-investment-grade business loans, taking the weighted average of financial and nonfinancial borrowers, which resulted in loan-loss rates of 8.3 and 5.4 percent for the 2018 and 2019 CCARs, respectively. The weights used are the shares of each sector of the stress-tested banks' total unsecured non-investment-grade business loans. See "Dodd-Frank Act Stress Test 2019: Supervisory Stress Test Methodology," Board of Governors of the Federal Reserve, March 2019, <https://www.federalreserve.gov/publications/files/2019-march-supervisory-stress-test-methodology.pdf>, and "Dodd-Frank Act Stress Test 2020: Supervisory Stress Test Methodology," Board of Governors of the Federal Reserve, March 2020, <https://www.federalreserve.gov/publications/files/2020-march-supervisory-stress-test-methodology.pdf>.

³⁶ Specifically, the loan-loss rates calculated from the 2018 and 2019 stress tests were 17.2 and 11.5 percent, respectively.

³⁷ Reflecting the higher priority and security embedded in the terms of the PLF and ELF facilities, LGDs were set as 90 percent for NLF, 75 percent for PLF, and 60 percent for ELF. This implied loss rates ranging from 8.4 to 12.7 percent.

REFERENCES

- Berg, T., A. Saunders, and S. Steffen. 2016. “The Total Cost of Corporate Borrowing in the Loan Market: Don’t Ignore the Fees.” *JOURNAL OF FINANCE* 71: 1357-92.
- Bräuning, F., and T. Paligorova. 2021. “Uptake of the Main Street Lending Program.” Federal Reserve Bank of Boston, *CURRENT POLICY PERSPECTIVES*, March 19.
- Bräuning, F., J. L. Fillat, and J. C. Wang. 2021. “A Helping Hand to Main Street Where and When It Was Needed.” Federal Reserve Bank of Boston, *CURRENT POLICY PERSPECTIVES*, May 27.
- Briggs, J., and B. Walker. 2020. “US Daily: Supporting Small Businesses in a Pandemic: Lessons from Other Countries.” Goldman Sachs Economic Research, November 17.
- Calomiris, C. W., C. P. Himmelberg, and P. Wachtel. 1995. “Commercial Paper, Corporate Finance, and the Business Cycle: A Microeconomic Perspective.” *CARNEGIE-ROCHESTER CONFERENCE SERIES ON PUBLIC POLICY* 42, no. 1: 203-50, June.
- Cantu, C., P. Cavallino, F. De Fiore, and J. Yetman. 2021. “A Global Database on Central Banks’ Monetary Responses to COVID-19.” BIS Working Paper no. 934.
- Cavallino, P., and F. De Fiore. 2021. “Central Banks’ Response to COVID-19 in Advanced Economies.” BIS Bulletin no. 21.
- Chodorow-Reich, G., H. Cooperman, O. Darmouni, S. Luck, and M. Plosser. 2020. “Weathering the Storm: Who Can Access Credit in a Pandemic?” Federal Reserve Bank of New York *Liberty Street Economics*, October 13. <https://libertystreeteconomics.newyorkfed.org/2020/10/weathering-the-storm-who-can-access-credit-in-a-pandemic.html>
- English, W. B., and J. N. Liang. 2020. “Designing the Main Street Lending Program: Challenges and Options.” Hutchins Center Working Paper #64, Brookings Institution.
- Fettig, D. 2002. “Lender of More Than Last Resort.” Federal Reserve Bank of Minneapolis.
- Hackley, H. H. 1973. “Lending Functions of the Federal Reserve Banks: A History.” Washington, D.C.: Board of Governors of the Federal Reserve System.
- Minoiu, C., R. Zarutskie, and A. Zlate. A. 2021. “Motivating Banks to Lend? Credit Spillover Effects of the Main Street Lending Program.” Working paper.
- Morgan, D. P., and S. Clampitt. 2021. “Up on Main Street.” Federal Reserve Bank of New York *Liberty Street Economics*, February 5. <https://libertystreeteconomics.newyorkfed.org/2021/02/up-on-main-street.html>.

REFERENCES (CONTINUED)

Rauh, J. D., and A. Sufi. 2010. “Capital Structure and Debt Structure.” *REVIEW OF FINANCIAL STUDIES* 23, no. 12 (December): 4242–80.

Sablik, T. 2013. “Fed Credit Policy during the Great Depression.” Federal Reserve Bank of Richmond *ECONOMIC BRIEF* 13-03 (March).

THE FED'S CENTRAL BANK SWAP LINES AND FIMA REPO FACILITY

Mark Choi, Linda Goldberg, Robert Lerman, and Fabiola Ravazzolo

OVERVIEW

- The onset of the COVID-19 pandemic in early 2020 led to simultaneous supply and demand shocks in global U.S. dollar funding markets, with banks and nonbanks cutting back on dollar intermediation just as market participants rushed to build up precautionary cash balances.
- Toward the same end, some foreign official sector investors sold off large volumes of U.S. Treasury securities, exacerbating liquidity strains in that market as well.
- To address these pressures, in March 2020 the Federal Reserve eased the terms on its standing swap lines in collaboration with other central banks, reactivated temporary swap agreements, and introduced the Foreign and International Monetary Authorities (FIMA) Repo Facility.
- This article provides key insights into the design and operation of the swap lines and FIMA Repo Facility, highlighting evidence that they can reduce strains in global dollar funding markets and the U.S. Treasury market during extreme stress events.

The severe global economic impact of the rapid spread of COVID-19 in early 2020 prompted a quick and broad policy response from fiscal authorities and central banks. This article focuses specifically on the policy actions taken by the Federal Open Market Committee (FOMC) in March 2020 to address pressures in offshore dollar funding markets and U.S. Treasury market dislocation.¹ These actions included expanding and enhancing dollar liquidity swap line arrangements with selected foreign central banks (hereafter CB dollar swaps) and establishing a new repurchase operation (repo) facility with foreign and international monetary authorities (FIMA) that hold accounts at the Federal Reserve—the FIMA Repo Facility.

This article provides details on the conditions that spurred the creation and use of these facilities, descriptions of their operational elements, and evidence of their effectiveness in containing strains in credit and offshore dollar funding markets. We begin with a review of developments in the offshore dollar funding market and their effects on broader markets, such as the U.S. Treasury market and foreign exchange (FX) swap market. We then discuss the details of the Federal Reserve's CB dollar swaps and FIMA

Linda Goldberg is a financial research advisor for Financial Intermediation Policy Research in the Federal Reserve Bank of New York's Research and Statistics Group. Mark Choi, Fabiola Ravazzolo, and Robert Lerman are policy advisors in the Bank's Markets Group. Emails: mark.choi@ny.frb.org, linda.goldberg@ny.frb.org, robert.lerman@ny.frb.org, fabiola.ravazzolo@ny.frb.org.

The views expressed in this article are those of the authors and do not necessarily reflect the position of the Federal Reserve Bank of New York or the Federal Reserve System. To view the authors' disclosure statements, visit https://www.newyorkfed.org/research/epr/2022/epr_2022_FIMA-repo_choi.html.

Repo Facility actions, measures aimed at enhancing the provision of U.S. dollar liquidity internationally to address strained market conditions and support credit provision abroad and in the United States. Historically, CB dollar swaps have been a means of facilitating the flow of dollars through foreign central banks to financial institutions in their respective jurisdictions. The new FIMA Repo Facility provides broader access to a dollar liquidity backstop than CB dollar swaps, enabling foreign official institutions to temporarily exchange their U.S. Treasury holdings in custody at the Federal Reserve for short-term dollar liquidity.

The article also provides perspective on the efficacy of these backstop facilities. Dollar settlements through these facilities helped stabilize financial markets and sustain the flow of credit to borrowers, thus dampening the amplification effects of the pandemic shock. The new FIMA Repo Facility, still not broadly used as of this publication, should likewise provide stabilizing effects in future periods of turmoil, whether they center on specific countries or affect funding markets more broadly. The article concludes by highlighting lessons learned about the design of such facilities. Operational readiness, agility, and a network of strong central banking relationships continue to be important features given the ever-changing dollar funding landscape.

1. GLOBAL U.S. DOLLAR FUNDING MARKETS

Offshore dollar funding markets are one element of the extensive global use of the U.S. dollar in international trade and financial transactions (Goldberg and Lerman 2019). A large amount of dollar funding flows through different types of financial intermediaries and a variety of market instruments.² The interconnectedness of markets worldwide can quickly transmit both favorable conditions and strains across financial markets and institutions, affecting financial conditions, credit provision, and monetary policy transmission in the United States and around the world.³

Under normal conditions, the broad participation and high volume of activity in U.S. dollar funding markets mean that borrowers incur relatively low funding rates. International capital flows and global dollar liquidity respond relatively smoothly to changes in risk and returns across markets, without excessive price impact. When conditions are stressed, price dispersion occurs, as gaps widen between the cost of funds for some market participants and the price that other market participants are willing to pay. Global liquidity flows, the more volatile part of international capital flows, can retrench and redirect, particularly as global banks and financial institutions realign and redeploy scarce funds via their internal capital markets.

In the decade following the global financial crisis (GFC), the U.S. dollar funding landscape underwent significant structural changes. Largely attributed to post-GFC reforms of banking regulations, these changes included a reduction in currency mismatches, smaller global footprints for weaker banks, and shifts in the business models and geographic reach of different intermediaries (BIS CGFS 2020). Dollar funding flows shifted somewhat from a concentration in Europe toward institutions in Japan and some emerging market economies (EMEs).⁴ Moreover, the capacity of banks to engage in market-making activity appears to have become more constrained because of changes in the regulatory environment, helping drive an increase in participation by nonbanks as providers and users of U.S. dollar funding (BIS CGFS 2021).

Strong global risk appetite and historically low levels of U.S. Treasury yields supported cross-border U.S. dollar investment flows to EMEs and increased demand for dollar-denominated borrowing in those countries. During this period, foreign central banks, particularly those in many EMEs, increased the size of their FX reserves, including U.S. dollars, to better manage local dollar funding needs in the event of sizable capital outflows.

In March 2020, extreme uncertainty amid coronavirus-related lockdowns and expectations of a severe global economic downturn led to simultaneous supply and demand shocks in global U.S. dollar funding markets. Greater risk aversion and a desire to hold precautionary cash balances led banks and nonbank financial institutions to reduce dollar intermediation in funding markets. Corporations, faced with tightened access to U.S. dollar funding markets amid an uncertain economic outlook, drew heavily on their committed credit lines with banks. Some of these committed credit line draws were concentrated in the U.S. branches of foreign banking organizations (FBOs), resulting in significant increases in bank loans and new dollar funding needs. Some non-U.S. banks and corporations sought to build extra liquid dollar balances. Non-U.S. asset managers with sizable U.S. securities holdings, particularly Japanese insurance companies, increased hedging demand for U.S. dollars in light of the significant volatility in the FX market and some U.S. financial markets, especially U.S. Treasury and agency MBS markets.⁵ Some countries, including EMEs, experienced capital outflows as international investors decreased holdings of local currency and dollar-denominated sovereign assets (FSB 2020) and sold U.S. dollar-denominated assets out of their FX reserves.

One standard metric that reflects the gap in the cost of funds is the FX swap basis spread (sometimes referred to as the basis), constructed by comparing the implied cost of U.S. dollar funding from an FX swap transaction of a specific tenor to a direct U.S. dollar interest rate. A positive FX swap basis spread reflects a premium to borrow U.S. dollars in the FX swap market, meaning that borrowers pay a higher cost for obtaining funds than the relevant U.S. dollar unsecured rates would suggest.⁶

At the onset of the pandemic in March 2020, the strains initially were most pronounced in shorter-term funding markets, generally with tenors under three months, across both advanced economies and EMEs. Conditions had started to deteriorate at the end of February and became particularly strained around mid-March for short tenor transactions (Chart 1). The premium to obtain U.S. dollar funding in the FX swap market increased to levels last seen in 2008, particularly in the dollar-yen currency pair, reflecting the recent growth in dollar activity among Japanese banks and in holdings of U.S. assets among Japanese nonbank financial entities (BIS CGFS 2020). Across EME currency pairs, the premium to obtain U.S. dollars in the FX swap market also significantly increased in March 2020. However, basis spreads of EME currency pairs remained narrower than peaks reached during the GFC, reflecting a decline in vulnerabilities associated with the dollar funding activities of banks in these countries following post-GFC banking sector reforms (EMEAP 2020).

These strains can also show up in the volume of cross-border funding flows. The flow of funds between branches of FBOs operating in the United States and their home-country parent organizations responded quickly to the pattern of funding needs both within the United States and in foreign markets. The U.S. branches of FBOs received greater net internal capital flows from their parent banks (or reduced outflows went from the

CHART 1
 Three-Month FX Swap Basis Spreads for Selected Currencies against the U.S. Dollar

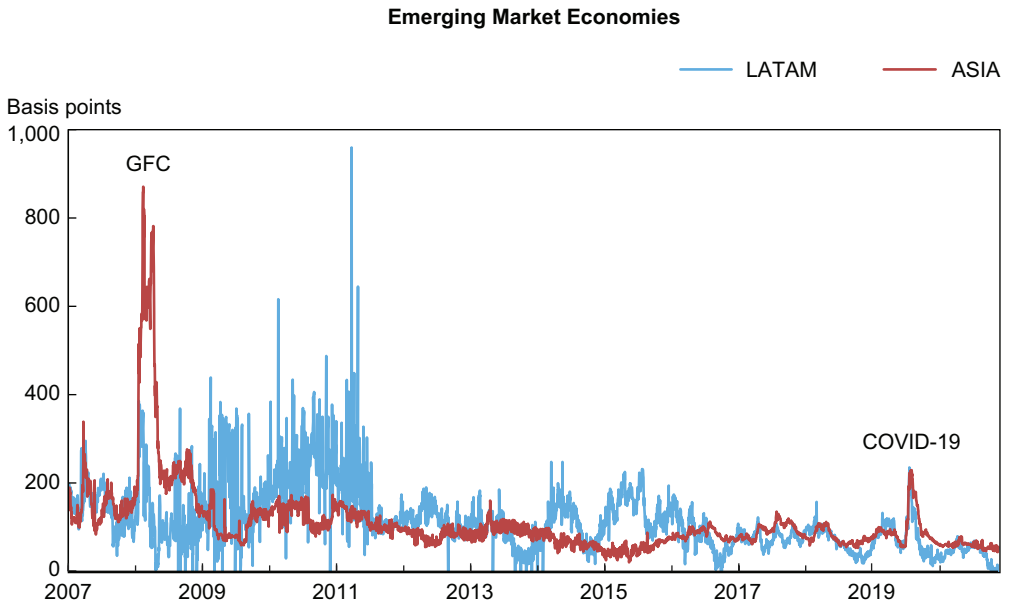
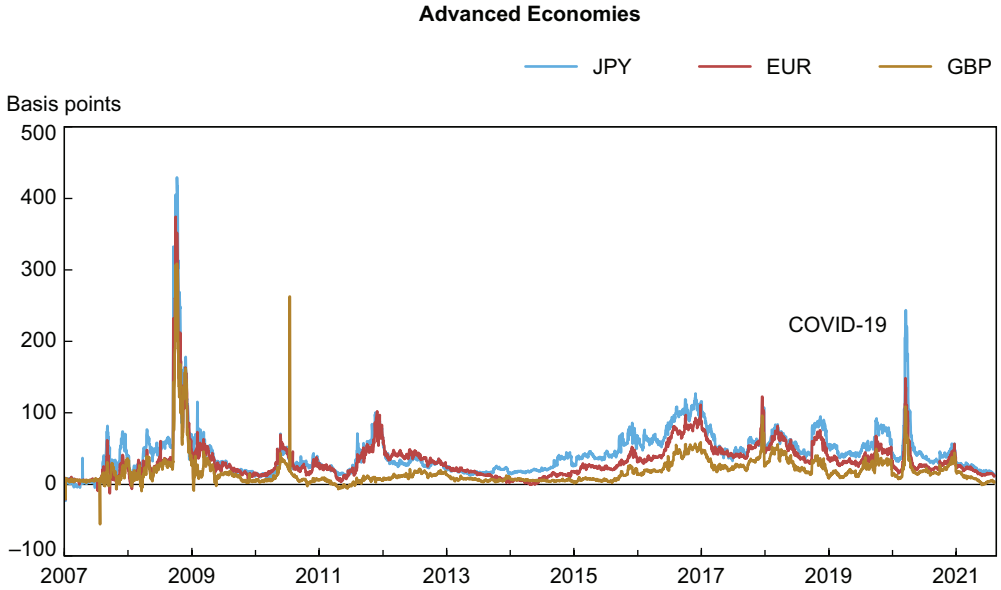

Sources: Bloomberg L.P.; authors' calculations.

Notes: Data are as of 11:00 a.m., London time, and are based on overnight unsecured funding rates (OIS) along with bilateral spot and forward exchange rates. A positive number reflects a premium to borrow or hedge U.S. dollars. JPY is Japanese yen, EUR is euro, GBP is British pound sterling. LATAM series shows the simple average of FX swap basis spreads for the Brazilian real, the Chilean peso, the Colombian peso, and the Mexican peso. ASIA series shows the simple average of FX swap basis spreads for the Hong Kong dollar, the South Korean won, the Singapore dollar, and the Taiwan dollar.

CHART 2

FIMA Treasury Holdings and the Fed's Foreign Repo Pool

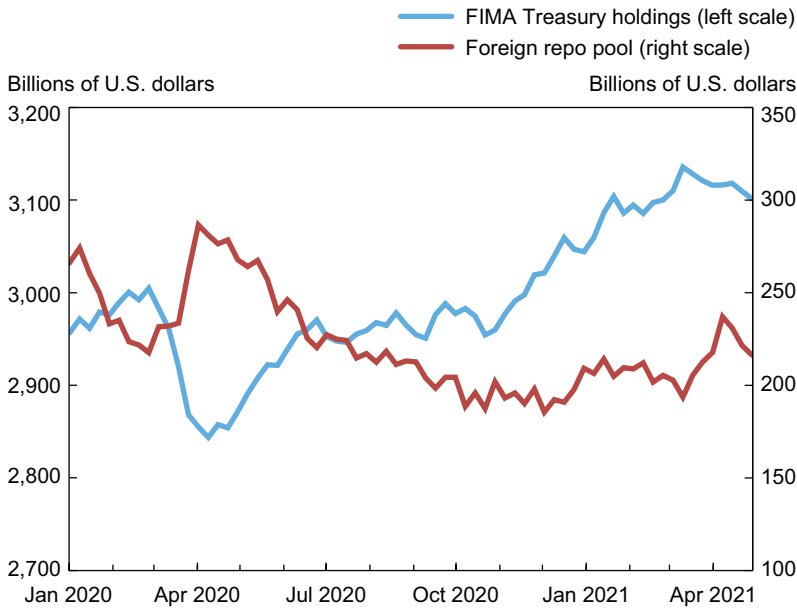

Source: Federal Reserve Bank of New York.

U.S. branches to the parent organizations). Cetorelli, Goldberg, and Ravazzolo (2020b) show that these adjustments corresponded to a combination of increased loan demand by their clients and decreased dollar funding supply in private capital markets in March. Banks thereafter met their excess funding needs by also using dollars their parent organizations accessed through the CB dollar swaps. This directional flow of dollars through FBOs differed from that which occurred in the early stages of the GFC, when European banking organizations were particularly strained and obtained dollar funding from their U.S. branches through internal capital market transfers (Goldberg and Skeie 2011, and Cetorelli and Goldberg 2011).

Amid tighter conditions in dollar funding markets, a sudden shift in global risk sentiment triggered significant capital outflows from some EMEs, reflecting reduced investor interest in holding EME currencies and facing EME counterparties. Some foreign official sector investors sold U.S. Treasury securities, held as part of their official foreign currency reserves, to build precautionary dollar liquidity buffers, address the dollar funding needs of local institutions, and facilitate FX intervention. The significant volume of these foreign official sales was widely seen as exacerbating strained liquidity conditions in the U.S. Treasury market. Foreign official holdings of Treasury securities declined by nearly \$150 billion in March 2020 and by another \$70 billion in April 2020 (Chart 2). Consistent with the precautionary liquidation motive, cash balances held by foreign official investors at the Federal Reserve and invested overnight in the foreign repo pool spiked by nearly \$70 billion in March to a near-record high of approximately \$300 billion.

2. CENTRAL BANK DOLLAR SWAPS AND FIMA REPO

The Federal Reserve met the March 2020 strains with important facility changes. Before detailing these, we note the long history of central bank operations in markets for dollar liquidity, highlighting changes in institutional features and objectives over time. We then explain and compare the features, operational aspects, and relevant usage of the CB dollar swaps and complementary FIMA Repo Facility from the vantage point of developments since March 2020.

2.1 The Central Bank U.S. Dollar Swap Arrangements

Swap agreements were established in the early 1960s between the Federal Reserve and a number of other central banks. The primary purpose of CB dollar swaps was to fund FX interventions, but they were also used to help some central banks in Europe manage shocks on the Eurodollar market by providing temporary liquidity funding in dollars (McCauley and Schenk 2020). The nominal value of the swap line limits increased in 1973, when the Bretton Woods system ended, and again in 1978, after the dollar exchange rate crisis. However, the facility was seldom used after the early 1980s and eliminated in 1998 in anticipation of the adoption of the euro. The FOMC maintained swap lines with Canada and Mexico. As discussed in Bordo, Humpage, and Schwartz (2014) and Truman (2016), many FOMC participants instead favored a mechanism capable of providing emergency dollar liquidity in the event of a payments system meltdown.

CB dollar swaps were redeployed in late 2007, providing U.S. dollar liquidity to help smooth strains in global U.S. dollar funding markets (Goldberg, Kennedy, and Miu 2011). These swaps were solely intended to provide U.S. dollar liquidity on a temporary basis and not to fund FX intervention, as had been the case in the past. The Federal Reserve initially entered into U.S. dollar liquidity swap arrangements with the European Central Bank (ECB) and Swiss National Bank, further expanding agreements during 2008 to include a total of fourteen central banks.⁷ In early 2010, as the GFC subsided, CB dollar swaps for all counterparties were briefly discontinued. In May 2010, in the wake of the euro-area sovereign and banking crisis, swap arrangements were reintroduced between the Federal Reserve and five other central banks in countries with large dollar financial centers (Bank of Japan, European Central Bank, Bank of England, Swiss National Bank, and Bank of Canada). These arrangements have also been reciprocal between central banks in this network since November 2011, meaning any central bank in the network can draw local currency liquidity from another in the event of funding disruptions in any of the participating currencies. The swap lines among this network were initially implemented on a temporary basis. However, given their effectiveness as a backstop liquidity facility to stabilize offshore dollar funding markets, they were converted into standing facilities in October 2013 and central banks in the network are referred to as standing swap line central banks (SSCBs).

Main developments in CB dollar swaps during the COVID-19 outbreak

In mid-March 2020, as funding conditions deteriorated globally, the network of SSCBs took a series of steps to ease access to the swap lines. On March 15, the network lowered the price

CHART 3

Peak U.S. Dollar Swaps Outstanding during 2020 and the Global Financial Crisis

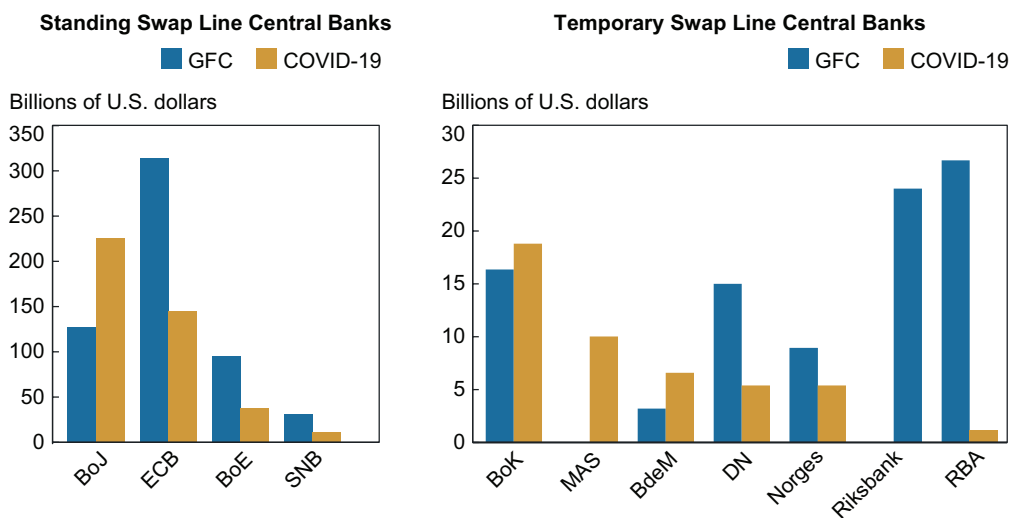

Source: Federal Reserve Bank of New York.

Notes: The Bank of Canada, Central Bank of Brazil, and Reserve Bank of New Zealand never used the facility. Standing swap line central banks are the Bank of Japan (BoJ), the European Central Bank (ECB), the Bank of England (BoE), and the Swiss National Bank (SNB). Temporary swap line central banks are the Bank of Korea (BoK), the Monetary Authority of Singapore (MAS), Banco de México (BdeM), Danmarks Nationalbank (DN), Norges Bank (Norges), Sveriges Riksbank (Riksbank), and the Reserve Bank of Australia (RBA).

from a spread of 50 basis points to a spread of 25 basis points over overnight indexed swaps and added an operation for eighty-four-day term funding to its existing weekly operation for seven-day funds. On March 20, it increased the frequency of the operations for seven-day funds from weekly to daily. In addition, the FOMC granted temporary swap lines to nine other central bank counterparties (temporary swap line central banks, hereafter TSCBs), all of which had received dollar swap lines during the GFC (March 19). Originally authorized until September 30, 2020, swap line access for the TSCBs was extended twice for six months and then for another three months, with planned expiration on December 31, 2021.

Swap line usage peaked at \$449 billion in late May 2020, compared with \$598 billion drawn during the GFC. Aggregate Bank of Japan and ECB usage accounted for about 82 percent of the total peak. The Bank of England and the Swiss National Bank had lower usage than during the GFC (Chart 3), while the Bank of Canada did not draw on its swap line. In 2020, aggregate usage by TSCBs peaked at less than \$50 billion, compared with a peak of \$96 billion during the GFC. This lower usage reflected a decline in vulnerabilities associated with bank dollar funding activity in these countries following banking sector reforms undertaken after the GFC (EMEAP 2020). Among TSCBs, there was no usage by the Central Bank of Brazil, the Riksbank, and Reserve Bank of New Zealand, and relatively small usage by the Reserve Bank of Australia and the other Scandinavian central banks.⁸ The Monetary Authority of Singapore used the facility, a step it had not taken during the GFC, reflecting Singapore’s increased role as a dollar financial intermediation center in Asia (EMEAP 2020). Among the TSCBs, the Bank

of Korea had the largest usage and Banco de México's use exceeded GFC levels, reflecting increased hedging of U.S. dollar-denominated investment and trade financing by nonfinancial entities in these countries.

What are the operational mechanics of the CB dollar swaps?

The Federal Reserve's CB dollar swap network is designed to contain deterioration in dollar funding markets by providing foreign central banks with U.S. dollar liquidity, which they can supply to financial institutions in their respective jurisdictions. By providing dollar liquidity directly to the foreign central bank, the CB swaps are structured to help limit credit risk to the Federal Reserve. The Federal Reserve transacts directly only with the foreign central bank, which then distributes dollar liquidity to counterparties that are eligible for access to the facilities. The CB swaps are also priced as backstop facilities to help ensure that they are used largely in times of acute stress and are not replacements for private market activity in normal times.

When a foreign central bank draws on its CB dollar swaps, dollar liquidity is typically distributed by the drawing central bank to financial institutions through local dollar operations. Exhibit 1 illustrates the flow of liquidity with an authorized central bank through several steps: (1) The foreign central bank holds a dollar operation on a schedule preapproved with the Federal Reserve, typically in the format of a repurchase agreement (repo) in which dollars are exchanged for local-currency collateral. Eligible counterparties in the foreign central bank's dollar operation are typically the same as those which participate in regular local currency operations. (2) When the operation of the foreign central bank concludes, the central bank makes a request to draw dollars from the Federal Reserve through the swap line arrangement and both formally agree to a draw. (3) The foreign central bank swaps an equivalent amount of local currency for dollars at the tenor of the operation (for example, seven days or eighty-four days) and then provides those dollars to local institutions which bid in the offered operation. The Federal Reserve charges a fee to the foreign central banks based on the relevant U.S. dollar OIS plus a spread, currently 25 basis points.⁹ (4) The foreign central bank passes that fee on to its counterparties, though it is not required to do so. Local institutions that bid at the dollar auction can use the proceeds to meet their own liquidity needs or those of their overseas branches, provide dollar intermediation to end users, and/or build precautionary liquidity buffers (generally deposited at the Federal Reserve).¹⁰ (5) At maturity, local institutions return dollars to the foreign central bank and receive back the securities originally purchased. (6) The foreign central bank then returns the dollars it drew, plus the aforementioned fee, to the Federal Reserve and receives back its local currency. The Federal Reserve does not bear FX risk since the same amount of dollars is exchanged at the settlement and maturity of the swap transaction with the foreign central bank.

2.2 The Temporary FIMA Repo Facility

Another key facility development was the Federal Reserve's establishment of the FIMA Repo Facility on March 31, 2020. Originally authorized to operate until September 30, 2020, the

EXHIBIT 1

Tracing Liquidity Flows through Central Bank Swap Lines

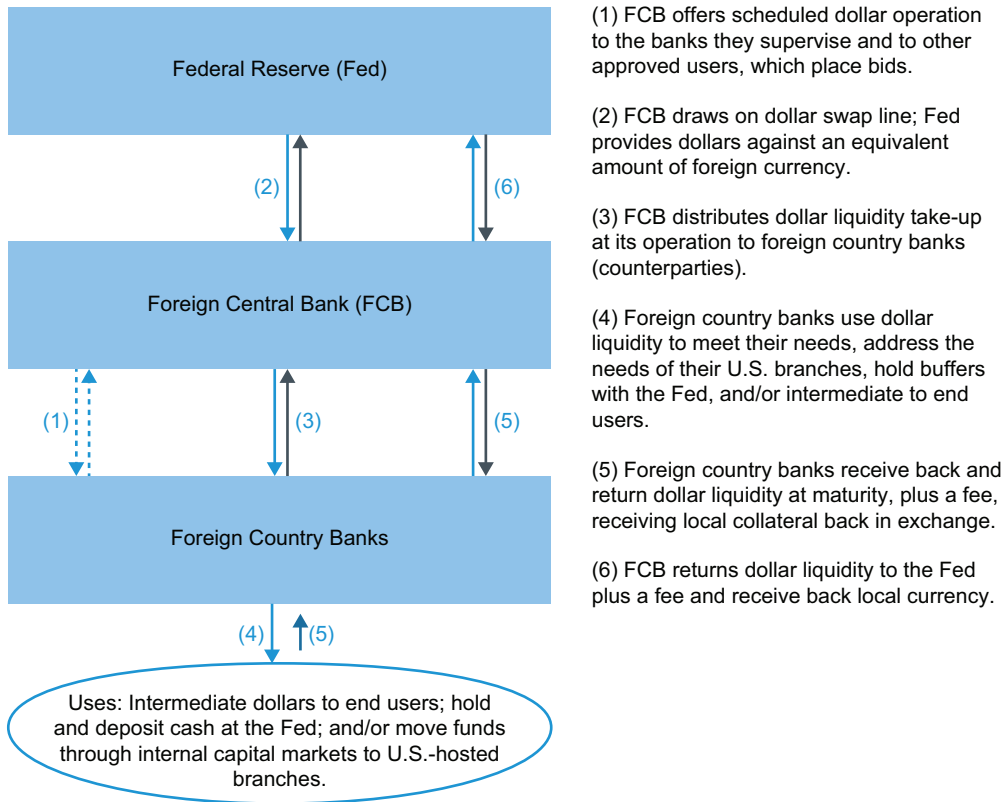

Source: Federal Reserve Bank of New York.

Note: Solid lines indicate flows of dollars and dotted lines indicate a step without flows.

facility was twice extended for six months and then converted to a standing facility on July 28, 2021. In the event that dollar liquidity becomes scarce, this facility serves to backstop the smooth functioning of the U.S. Treasury market, reassuring FIMA account holders of their ability to secure dollar liquidity through repo transactions with the Federal Reserve in times of unusual market stress, rather than by selling their Treasury securities or financing Treasury securities in the private repo market. The facility complements the CB dollar swaps in helping to ease strains in global dollar funding markets by providing temporary dollar liquidity to a much broader range of foreign official institutions (FIMA account holders) at a backstop interest rate. The extent of central bank access to dollar liquidity had been a point of debate with respect to the structure of the international monetary system, given the extensive international role of the dollar.

Market participants welcomed the announcement of the FIMA Repo Facility as part of a broader set of measures implemented by the Federal Reserve. The facility eased pressure on foreign official institutions to sell Treasury securities for precautionary reasons, but actual usage was minimal in the period soon after introduction and has remained so in 2021.¹¹

Nevertheless, central banks' increased confidence in their ability to raise dollar liquidity through the facility likely contributed to a strong return to Treasury investments by the second week of April 2020 and a drawdown of the large accumulations of precautionary cash balances seen in the Federal Reserve's foreign repo pool (Chart 2).

Tracing liquidity flows through the FIMA Repo Facility

The FIMA Repo Facility allows foreign official institutions to temporarily raise dollars by selling U.S. Treasury securities to the Federal Reserve's System Open Market Account (SOMA) and agreeing to buy them back at the maturity of the repurchase agreement. The term of the agreement at the time of the facility's establishment and subsequent renewals is overnight with an option for account holders to roll over as needed. Transactions are conducted at a rate designed to generally be above market repo rates when the Treasury market is functioning well, therefore positioning the facility as a backstop.¹² Most FIMA account holders, which consist of foreign central banks and other foreign monetary authorities with custodial accounts at the Federal Reserve of New York, are eligible to apply to use the facility, but applications for usage of the facility must be approved by the Federal Reserve.¹³

Once approved to use the facility, a FIMA account holder can draw on it at any time. The operational process and flow of liquidity is illustrated in steps (1) to (9) in Exhibit 2. The process begins with a FIMA account holder sending a trade request to the Federal Reserve (1). If the terms of the requested trade are within facility parameters, the Federal Reserve sends back a trade confirmation (2).¹⁴ The foreign central bank then temporarily sells U.S. Treasury securities to the Federal Reserve (3), which first involves the movement of U.S. Treasury holdings in an amount equivalent to the value of the repo agreement (minus a haircut) from the foreign central bank's main custody account to another specially designated custody account under its control and then to a SOMA custody account at the Federal Reserve. Once the foreign central bank's U.S. Treasury holdings are in the Federal Reserve's custody account, the Federal Reserve sends the cash value of the repo to the foreign central bank's specially designated custody account (4). The foreign central bank decides how to remit the dollar proceeds of the repo, which generally results in a transfer of dollars to local institutions with funding needs and/or funding of FX spot interventions (5, 6).¹⁵ Should the duration of the foreign central bank's dollar liquidity need exceed one day, it has the option to roll over the repo. In this event, the U.S. Treasury securities held in custody in the Federal Reserve's account as part of the repo are revalued (that is, repriced and given a haircut again) and the amount of Treasury securities held as accordingly.¹⁶ Local institutions return the dollars they borrowed to the foreign central bank at maturity (7). Likewise, the foreign central bank repurchases its U.S. Treasury securities at maturity (8) and returns the dollars to the Federal Reserve (9).

The Federal Reserve is responsible for all aspects of post-trade clearing, settlement, and collateral management in contrast with commercial tri-party repo arrangements in which the clearing agent performs these functions. This reliance on the Federal Reserve's back-office infrastructure for FIMA repos has had important implications for operational readiness, which will be discussed later.

EXHIBIT 2

The Stylized Flow of Liquidity through the FIMA Repo Facility

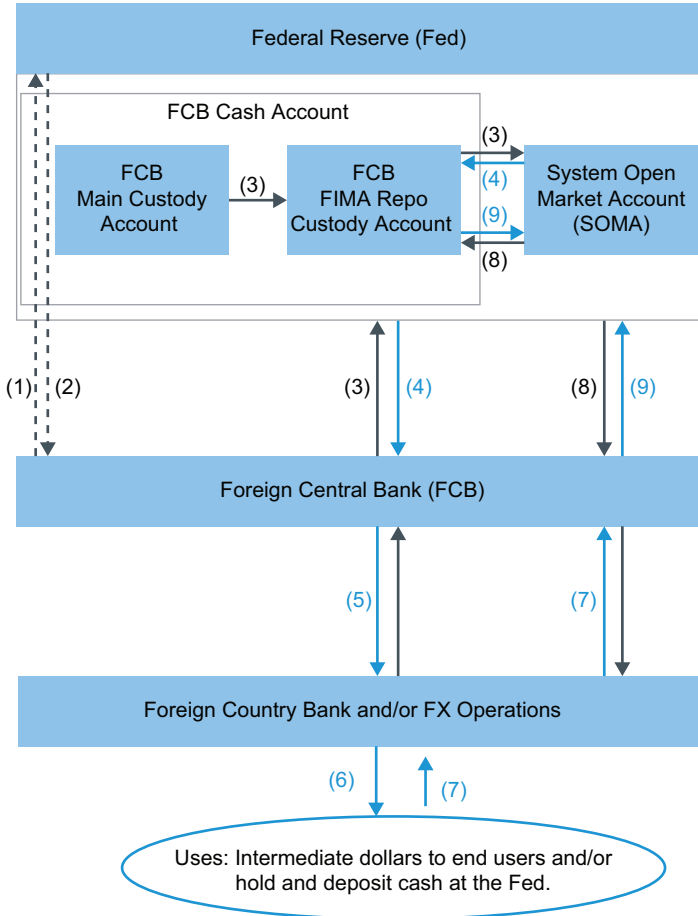

- (1) FCB requests a trade.
- (2) Fed confirms trade.
- (3) FCB temporarily sells U.S. Treasury securities to the Fed, with the FCB moving the securities from its main custody account to a SOMA account.
- (4) Fed sends cash value of the repo to the FCB.
- (5) FCB provides obtained funds to local institutions and/or funds FX operations against local collateral or currency.
- (6) Foreign country banks use dollar liquidity to meet their needs, intermediate to end users, and/or hold and deposit cash at the Fed.
- (7) At maturity, foreign country banks receive back dollars from their counterparties, return funds to the FCB.
- (8) FCB repurchases U.S. Treasury securities at maturity.
- (9) FCB returns dollars to the Fed.

Source: Federal Reserve Bank of New York.

Notes: Solid blue lines indicate flows of U.S. dollars. Solid gray lines indicate exchange of U.S. Treasury securities in steps (3), (4), and (8) or local securities in steps (5) and (7). Dotted lines indicate a step without flows.

Similarities and differences with the Fed's CB swaps

There are similarities and differences across the dollar facilities with respect to objectives, counterparties, and operational constraints (Table 1).

The FIMA Repo Facility is offered to a broader range of foreign official institutions compared with the narrower set of central bank swap counterparties and offers a lower level of credit risk to the Federal Reserve. For example, if a counterparty fails to return the dollars to the Federal Reserve, the Federal Reserve is left with U.S. Treasury securities. By contrast, in the event that dollars are not repaid in a swap transaction, the Federal Reserve would be left holding the local currency of the foreign jurisdiction, which may entail a higher risk of value loss.¹⁷

TABLE 1
Key Features of the FIMA Repo Facility and Central Bank Dollar Swaps

Feature	FIMA Repo Facility	CB Dollar Swaps
Backstop tool	Yes	Yes
Objective(s)	Dollar liquidity provision and U.S. Treasury market function support	Dollar liquidity provision
Federal Reserve Counterparty	Foreign and international monetary authority account holders at the Federal Reserve/New York Fed (e.g., foreign central banks)	Selected foreign central banks
Asset exchanged for U.S. dollars	U.S. Treasury securities	Foreign currency
Custodian of exchanged asset	Federal Reserve	Foreign central banks
Format	Standing facility	Five standing swap lines and nine temporary swap lines
Transaction request	Ad hoc at the request of approved FIMA account holders	Pre-approved schedules of operations
Transaction maturity	Overnight	Up to 88 days
Maximum position size	U.S. Treasury holdings at the New York Fed, subject to internal counterparty limits communicated bilaterally to applicants	Unlimited for standing swap lines; capped at \$30 or \$60 billion for temporary swap lines
Pricing	For the temporary facility, the offering rate was the Fed's IOER plus a spread. For the standing facility the rate was set at 25 basis points (the top range of the Fed's effective federal funds target rate).	Term U.S. dollar OIS plus a spread (currently 25 bps)

Source: Federal Reserve Bank of New York.

Notes: *Format* means the time duration of the facility, *Term* is a transaction with a maturity longer than one day, *U.S. dollar OIS* is a U.S. dollar overnight indexed swap, *IOER* is the interest rate paid on excess reserves, and *intermediation* refers to the entity providing U.S. dollars to a private market counterparty. All central bank transaction instructions sent to the Federal Reserve (and the Federal Reserve Bank of New York) for use of both facilities are screened for sanctions compliance.

The new FIMA Repo Facility fills a gap in many foreign central banks' dollar liquidity management toolkits by providing a way to obtain dollar liquidity temporarily during periods of acute market stress without having to liquidate U.S. dollar asset holdings. By being able to temporarily exchange their security holdings instead of selling assets, central banks with access to the FIMA Repo Facility can avoid fire sales of U.S. dollar assets that may otherwise be required to generate dollar liquidity.

The amount of dollar liquidity available via the FIMA Repo Facility for any FIMA account holder is limited to the smaller of two quantities: the U.S. Treasury securities held at the Federal Reserve by the FIMA account holder or the counterparty limit, set bilaterally. In comparison, the standing swap lines have no specific limits, while the temporary swap lines are capped at \$30 or \$60 billion, depending on the central bank.¹⁸ Another difference is that in a CB swap transaction, unlike the FIMA repo, the reserve assets of the foreign central bank are unencumbered.

The CB swap and FIMA Repo facilities also differ in the tenor of dollar liquidity provided. Dollar funding through FIMA Repo facilities can only be obtained on an overnight basis. By contrast, the swap lines currently offer up to eighty-eight days of funding or such other periods the parties may agree on, though the current scheduled period for the standing swap lines is seven days. Although the FIMA Repo Facility does not offer additional longer-term funding, its existence provides reassurance of access to overnight liquidity, which can be rolled over. In this way, the facility can dampen precautionary asset sales and the associated cross-market amplification effects.

3. EFFECTS OF THE CENTRAL BANK DOLLAR SWAP AND FIMA REPO FACILITY

CB dollar swaps work through a number of channels to mitigate market strains. The dollars provided through swap central bank counterparties enable foreign commercial banks to access U.S. dollar liquidity at a lower cost than in the stressed private market, obviating the need to bid up rates excessively in the market. Moreover, these more favorable dollar liquidity terms allow foreign commercial banks to continue providing private credit when markets are strained. This credit provision spans direct lending by their branches in the United States as well as those in their home economies, including to nonbank financial intermediaries and other private borrowers. Having adequate access to dollar liquidity also enables FBOs to meet precautionary funding needs. The FIMA Repo Facility allows central banks without swap lines to gain access to backstop dollar liquidity, thus reducing the need of other foreign official institutions to sell their U.S. dollar reserve assets, which can help limit the amplification of stress in U.S. credit and other financial markets.

Research conducted around the introduction and expansion of CB dollar swaps during the GFC has shown that these facilities significantly reduced strains in U.S. dollar funding markets, as demonstrated by comparing FX swap basis spreads for directly covered currencies with those of other currencies after CB dollar swaps were employed in late 2007 and expanded during 2008 (see, for example, Baba and Packer [2009], Goldberg, Kennedy, and Miu [2011], and Bahaj and Reis [forthcoming]). The reduced funding strains occurred for the currencies and terms associated with dollar provision, but then extended to broader dollar funding markets.

Newer research shows that the suite of policy actions taken by the FOMC in 2020, including those related to the swap lines and the FIMA Repo Facility, helped stabilize U.S. dollar funding markets, supporting the continued flow of credit to the U.S. economy and beyond. These types of conclusions, by Cetorelli, Goldberg, and Ravazzolo (2020a, 2020b) and Goldberg and Ravazzolo (2021), are obtained by applying various methods that evaluate the effects of facility-related announcements on the settlement of dollar flows, and explore the effects of settlement and operationalization of dollars through these facilities on a range of funding and international credit indicators. The analytics also explore the effects of shifts in risk sentiment on FX swap basis spreads and international flows.

One method focuses on feedback from market observers. According to market participants, in mid-March 2020, banks became less interested in intermediating dollar flows to nonbanks, especially for term funding, given lingering uncertainty over the path and duration of the

coronavirus. It was only when banks had accumulated sizable excess dollar balances through take-up of central bank dollar operations funded through the swap lines network that they began to intermediate dollars to other regional banks and nonbanks. Overall, market participants were positive on the effects of access to dollars through central bank swap facilities and later offered positive feedback on the FIMA facility introduction.

Quantitative evidence comes from examining indicators of strains in dollar funding markets, international Treasury holdings, cross-border global liquidity flows, and exchange market pressure. The actual settlement of dollars through the facilities was key, obviating the need for banks to secure dollar funds in already stressed private markets. In March 2020, these funds were being used in part to support continued credit provision in the United States and abroad, helping to contain pandemic-induced contractions in credit supply. International capital flows largely reverted to pre-pandemic levels, as did exchange market pressures, after markets stabilized.

No matter the quality and quantity of the data we process, it is challenging to isolate the effects of particular facilities, especially given rapid shifts in market conditions and sentiment amid multiple official interventions. Subject to this caveat, below we provide key lessons based on our analysis of the available data.

Settlement of dollars through CB swap operations calmed funding strains, even more than announcements of facility-related developments.

Cetorelli, Goldberg, and Ravazzolo (2020a) analyze changes in selected FX basis spreads around key facility announcements and auction settlements: (1) the March 15 SSCB announcement, (2) the March 19 TSCB announcement, (3) the March 20 announcement of daily seven-day SSCB auctions, and (4) the March 31 FIMA Repo Facility announcement. The announcement window includes the day of and, in some cases, the day following the announcement. The FX swap basis spread changes over this window are compared with the average spread during the two days prior to the announcement.

On average across currencies, the TSCB activation, the daily SSCB auction analyses, and the FIMA Repo announcements corresponded with average reductions in FX swap basis spreads. Relative to other currencies, currencies with announcements related to SSCBs and TSCBs did not have significantly narrower FX swap basis spreads on and after announcement dates. By contrast, the announcement of the increased frequency of seven-day U.S. dollar operations lowered the rate of increase in the FX swap basis spreads for currency pairs of countries with SSCBs, as compared with the changes observed in FX swap basis spreads of other currency pairs. One causal interpretation of this pattern is that the latter announcement improved market conditions on the announcement day, relative to conditions over the prior two days. However, we caution that these results have no controls to benchmark what the respective changes in FX swap basis spreads would have been without the announcements.

The actual settlement of funds from U.S. dollar operations has had materially different effects on the FX swap basis spreads of currency pairs of the standing swap central banks versus those of all other currencies. After controlling for the effects of concurrent equity market volatility, the settlements of daily seven-day auctions on one-week FX swap basis spreads improved market conditions. In contrast, settlements of seven-day and eighty-four-day operations were not associated with immediate improvements in three-month swap basis spreads. Our interpretation is that initially the term liquidity obtained by banks was only partially channeled beyond the banking system and the relief provided to broader markets was delayed.

Over longer horizons, strains in dollar funding markets were reduced by access to CB swaps and later to the FIMA Repo Facility, while risk sensitivity also declined.

Goldberg and Ravazzolo (2021) conduct further analysis of how CB swaps and the FIMA Repo Facility influenced FX swap basis spreads over longer time horizons, using daily data on FX swap basis spreads for twenty-one currencies from January 2, 2020, through June 30, 2020. Three periods are compared: Period 1 covers February 1, 2020, through March 10, 2020; Period 2 covers March 19, 2020, through April 4, 2020; and Period 3 covers May 21, 2020, through June 30, 2020. All currencies on average exhibited an increase in FX swap basis spreads in the initial stress Period 2 compared with the pre-pandemic Period 1, but those currencies with access to CB swaps showed significantly lower strains. In the latter period, after the activation of the FIMA Repo Facility, those currencies recorded significantly greater declines in FX swap basis spreads compared with the pandemic stress period. On net and on average, all of these FX swap basis spreads returned to pre-pandemic levels by the third period.

Related regression analytics of the daily data show that, while both groups of currencies exhibited increased risk sensitivity from Period 1 to Period 2, the increase in sensitivity was significantly lower for currencies with access to swap lines. Comparing Period 3 with Period 2, the currencies that were instead associated with FIMA repo accounts experienced significantly larger reductions in the sensitivity of FX swap basis spreads to daily changes in risk sentiment as proxied by the VIX index (Chicago Board of Exchange Volatility Index).

Credit provision in the United States and abroad is supported by dollars settled through CB swap lines and potentially FIMA Repo Facility.

The COVID-19 shock had a significant impact on U.S. FBO branch balance sheets beginning in late February 2020. Cetorelli, Goldberg, and Ravazzolo (2020b) show that, as funding strains became evident, deposits began to decline and the net funding U.S. FBOs received from parent organizations rose. Other borrowings rose as well, including those secured through the fed funds market, the repo market, and the Federal Reserve's discount window.

Greater changes occurred in the third week of March, when FBO branch balance sheets registered a combined sharp decline in deposits, a marked increase in lending, further increases in other borrowing, and a substantial jump in funding received on net from their parent organizations. The sharp increase in lending was likely due to large customer draws on the sizable credit commitments in place with the branches rather than a reflection of new loan extensions. The freezing up of the corporate credit market led customers to draw on those lines, resulting—all else equal—in U.S. FBOs facing an increase in funding needs to match the increase in loans on their balance sheets. U.S. branches of FBOs with access to dollar liquidity through the dollar operations of SSCBs borrowed more internally from their parent organizations.

Following the increase in dollar availability through the standing swap lines, the share of net internal borrowing among U.S. branches of FBOs grew significantly more for U.S. branches that had access to these dollars and had larger needs for such funding. The swap dollars supported the flow of funds back to the United States, where hosted branches of foreign banks met needs generated by draws on committed credit lines when corporate funding markets were strained. U.S. branches of FBOs also held precautionary liquidity demanded by their banking organizations. The activation of internal funding channels within these banking organizations in response to the shock was more than sufficient to

support the balance sheet needs of FBO branches and continue the flow of credit to borrowers in the United States. The fact that the increase in internal borrowing was larger than what was immediately needed suggests that dollars obtained from parent companies were also used to boost overall precautionary liquidity or to support some of the liquidity needs of related intermediate holding companies.¹⁹

Goldberg and Ravazzolo (2021) provide additional insights through analysis of Treasury TIC data and BIS Locational Banking Statistics. In the initial stage of the pandemic, U.S. Treasury holdings of foreign entities declined broadly. These declines, sometimes described as part of a dash for cash, on average initially were not proportionately larger for countries without swap lines. Some of the dollars were placed in the Federal Reserve's foreign repo pool. On average, the individual countries that set up FIMA repo accounts further reduced U.S. Treasury holdings through May 2020, then rebuilt those holdings, eventually surpassing pre-pandemic values.

International capital flows, captured through the asset and liability data reported in BIS Locational Banking Statistics, show that banking systems with access to swap lines continued to provide credit in the early part of the pandemic, including to banking sector borrowers abroad, at a higher rate than other groups of countries. Cross-border lending through banks to both bank and nonbank borrowers was strongest for banking systems where central banks had swap line access. Differential patterns across countries declined after country access to the FIMA Repo Facility was established.

The facilities helped lower funding costs, support capital flows, and reduce the sensitivity of funding costs and capital flows to changes in risk sentiment. The speed and degree of normalization of conditions in offshore funding markets and in cross-border bank and international capital flows were dependent on access to different types of facilities, with strains normalizing at a slower pace and to a lesser extent in countries without access to standing swap arrangements.

4. POLICY CONSIDERATIONS

During the GFC and the COVID-19 pandemic, the Federal Reserve showed a commitment to well-functioning U.S. dollar funding and credit markets. The dollar liquidity that it made available in the early stages of the pandemic helped calm global dollar funding markets, support the provision of credit, and limit the disruptive financial amplification effects of the worldwide shock. The Federal Reserve, working in conjunction with other monetary authorities, demonstrated operational readiness, agility, and common purpose as the frequency of dollar operations was adjusted, auctions of longer funding tenors were added, and temporary swap lines were extended to additional central banks. Expertise previously developed during the GFC, both within the Federal Reserve and within some of its foreign counterparts, supported the swift introduction of the FIMA Repo Facility.

However, despite operational readiness around the CB dollar swaps, the announcement of facilities did not immediately eliminate all funding strains. The costs of dollar funding, such as three-month FX swap basis spreads, remained relatively elevated for some time despite sizable usage of CB dollar swaps. In some cases, market segmentation and intermediation frictions may have prevented U.S. dollar liquidity from reaching entities in need of liquidity, particularly nonbank financial intermediaries and corporations without access to the dollar operations of

swap central banks. For example, foreign banks appear to have met their own institutional needs, including for liquidity buffers, before passing funds through to other end-users. This raises a policy question about how to reduce the potential for funding market strains *ex ante* and then how to best respond to the range of institutional needs.

Indeed, some new vulnerabilities of the post-GFC dollar funding landscape stem from the increased role played by nonbank financial institutions, a point discussed in BIS CGFS (2021). Nonbanks have access to a narrower range of U.S. dollar funding sources, including central bank backstop facilities. In periods of stress, the large footprint of nonbank financial institutions in some markets also increases the risk of possible fire sales of dollar assets, potentially amplifying market volatility. Some of these dynamics were evident in March 2020, raising questions about how to reduce such vulnerabilities and the extent of dollar liquidity availability from backstop tools at local central banks.

Additionally, history informs us that not all crises unfold in similar ways. Compared with the GFC, an interesting novelty around the March 2020 take-up of swap central bank dollar operations is that foreign banks' parent companies helped cover the new dollar funding needs of their U.S. branches. Some of the dollar liquidity provided through the swap lines made its way back to the United States instead of remaining in offshore funding markets. This type of dynamic arises in part through the structure of regulation and also through the design of the swap agreements. U.S. branches of foreign banks are ultimately supervised by their respective home country central banks and supervisory authorities, which ensure their compliance with local capital and liquidity requirements.²⁰ The CB swaps are structured in a way that exposes foreign central banks to the credit risk of their local institutions and leverages foreign central bank expertise in distributing dollar liquidity. This design, built into the structure of regulation and into the central bank swaps themselves, allowed liquidity flows from swap lines to reach the most stressed parts of institutions, limiting the consequences for the rest of these organizations in the spring of 2020.

Finally, the COVID-19 experience highlights that, even though central banks held more FX reserves after the GFC, providing insulation to some of them, there were still potential amplification effects in a coordinated shock that gave rise to concentrated asset liquidation. The new FIMA Repo Facility, deployed in late March of 2020, should help address such strains in a future crisis by at least partially attenuating the need of reserve managers to sell U.S. Treasury holdings. Though the FIMA Repo Facility has seen minimal usage through 2021, its introduction provided a backstop that offers entities with accounts at the New York Fed the capacity to convert U.S. Treasury holdings into cash overnight, if needed. This may reduce precautionary (contingency) selling of U.S. Treasury securities and make U.S. Treasury assets more attractive to reserve managers by reducing holding costs (reflected in a reduction of liquidity premiums or convenience yields).

Overall, the CB swaps and the new FIMA Repo Facility are important tools for managing global dollar funding markets and are consistent with U.S. financial stability and economic objectives.

NOTES

Acknowledgments: For helpful comments, the authors thank colleagues at the Federal Reserve Bank of New York and the Federal Reserve Board, as well as the editor and an anonymous referee.

¹ To support market function and address dislocations in the U.S. Treasury market, the FOMC took other and more relevant direct actions. For details, see the following articles elsewhere in this special issue: “The Primary Dealer Credit Facility” and “The Federal Reserve’s Market Functioning Purchases.”

² Intermediaries that might provide U.S. dollars through one instrument, for example a loan, also need to fund that asset by borrowing U.S. dollars, for example, a U.S. dollar deposit. Intertwined in this process is the need to hedge risks, including those related to exchange rate, interest rate, and maturity, for which certain instruments, such as FX forwards and swaps, tend to be used. For a list of instruments and their characteristics, see Table 1, “U.S. Dollar Funding: An International Perspective,” <https://www.bis.org/publ/cgfs65.htm>.

³ For an interactive mapping of U.S. dollar funding flows, see Afonso, Ravazzolo, and Zori (2019), https://www.newyorkfed.org/research/blog/2019_LSE_Markets_Interactive_afonso.

⁴ For example, banks headquartered in Japan, the United Kingdom, France, Switzerland, and Canada engage in significant dollar lending, especially to other advanced foreign economies. Chinese and some other banks of East Asia’s emerging economies are significant suppliers of dollar-denominated credit, especially to other EMEs, as noted in EMEAP (2020).

⁵ Liao and Zhang (2020) show that there was a larger rise in the cost of dollar funding through FX swaps for currencies whose home jurisdictions had more positive net international investment positions (that is, their investment in foreign assets was larger than their foreign debts), corresponding with more demand for hedging of dollar investments. See <https://www.federalreserve.gov/econres/ifdp/files/ifdp1283.pdf>.

⁶ The relevant U.S. dollar unsecured rates in this paper are Overnight Indexed Swap (OIS) rates. The formula below provides an example based on the cost of borrowing euros in unsecured markets and converting them to U.S. dollars via the FX swap market and then comparing that with the rate paid to borrow U.S. dollars directly in the unsecured market:

$$EURUSD \text{ Swap Basis Spread} = \left[\frac{360}{tenor} \left(\left(\frac{forward(tenor)}{spot} \right) \left(1 + EurOIS(tenor) \frac{tenor}{360} \right) \right) - 1 \right] - USD \text{ OIS}(tenor)$$

where *spot* is the FX spot rate at time *t*, *forward(tenor)* is the FX forward rate contracted at time *t* for delivery at time *t+tenor*, and *EUROIS(t, tenor)* or *USD OIS(t, tenor)* is the uncollateralized euro or dollar interest rate from time *t* to time *t+tenor*, which in this case is the overnight interest swap rate.

⁷ See Goldberg, Kennedy, and Miu (2011) for details about central bank counterparties of standing and temporary swap arrangements in the global financial crisis period. Baba and Packer (2009) provide initial insights into smoothed strains in U.S. dollar funding markets. In addition to the Bank of Japan, European Central Bank, Bank of England, Swiss National Bank, and Bank of Canada, the counterparties to the nine temporary swap lines are the central banks of Australia, Brazil, Denmark, Mexico, New Zealand, Norway, Singapore, South Korea, and Sweden.

⁸ Gislén, Hansson, and Melander (2021) argue that lower usage of the dollar operations of the ECB and Scandinavian central banks most likely reflects the fact that European and Scandinavian banks had higher initial liquidity, higher capital, and lower dollar exposure than they did during the GFC.

⁹ Before being reduced on March 15, 2020, the price of CB dollar swaps had been set at U.S. dollar OIS plus 50 basis points as of November 30, 2011, during the euro-area financing turmoil, when the price was reduced from U.S. dollar OIS plus 100 basis points. For details on the 2011 price announcement, see <https://www.federalreserve.gov/newsevents/pressreleases/monetary20111130a.htm>.

¹⁰ See step (2) in the stylized balance sheet mechanics of central bank swap lines, Graph 2 in Aldasoro et al. (2020).

NOTES (CONTINUED)

¹¹ Aggregate volumes are reported in the weekly H.4.1 data release on the Federal Reserve's balance sheet under the repo line item "foreign official." See <https://www.federalreserve.gov/releases/h41/>.

¹² For the temporary facility, the rate was set at interest on excess reserves plus 25 basis points. When converted into a standing facility on July 28, 2021, the rate was set at 25 basis points.

¹³ See Choi, Nemeth, and Potter (2020) on central bank services. The Federal Reserve Bank of New York maintains cash and custody accounts for nearly every central bank in the world and the FIMA Repo Facility adds to a suite of Federal Reserve dollar-based correspondent banking and custody services.

¹⁴ For example, within transaction size limits and priced at the correct facility pricing.

¹⁵ FX intervention funded in this way would only be in the direction of currency sales to strengthen the domestic currency vis-à-vis the U.S. dollar.

¹⁶ That is, should the value of the purchased Treasury securities fall below the outstanding FIMA repo, additional Treasury securities are moved from the FIMA repo custody account to the SOMA and vice versa if the mark-to-market valuation (minus haircut) exceeds the amount of the outstanding FIMA repo.

¹⁷ Absent default, neither party in the swap transaction faces market risk because the spot and forward legs of the transaction are at the same exchange rate and the same dollar amount as for the FIMA repo transaction.

¹⁸ The temporary CB dollar swap facilities support the provision of U.S. dollar liquidity in amounts up to \$60 billion each for the Reserve Bank of Australia, the Banco Central do Brasil, the Bank of Korea, the Banco de México, the Monetary Authority of Singapore, and the Sveriges Riksbank, and \$30 billion each for the Danmarks Nationalbank, the Norges Bank, and the Reserve Bank of New Zealand. See <https://www.federalreserve.gov/newsevents/pressreleases/monetary20200319b.htm>.

¹⁹ See <https://www.federalreserve.gov/newsevents/pressreleases/bcreg20140218a.htm>.

²⁰ U.S. branches are subject to certain liquidity requirements (see, for example, 12 C.F.R. 252.157[c] at <https://www.ecfr.gov/current/title-12/chapter-II/subchapter-A/part-252>). Depending on their organizational form, they may also be subject to certain capital requirements.

REFERENCES

- Afonso, G., F. Ravazzolo, and A. Zori. 2019. "From Policy Rates to Market Rates—Untangling the U.S. Dollar Funding Market." Federal Reserve Bank of New York LIBERTY STREET ECONOMICS, July 8.
- Aldasoro, I., C. Cabanilla, P. Disyatat, T. Ehlers, P. McGuire, and G. von Peter. 2020. "Central Bank Swap Lines and Cross-Border Bank Flows." Bank for International Settlements BIS BULLETIN, no. 34.
- Baba, N., and F. Packer. 2009. "From Turmoil to Crisis: Dislocations in the FX Swap Market before and after the Failure of Lehman Brothers." JOURNAL OF INTERNATIONAL MONEY AND FINANCE 28, no. 8 (December): 1350-74.
- Bahaj, S., and R. Reis. Forthcoming. "Central Bank Swap Lines: Evidence on the Effects of the Lender of Last Resort." REVIEW OF ECONOMIC STUDIES.
- Bank for International Settlements, Committee on the Global Financial System (BIS CGFS). 2020. "U.S. Dollar Funding: An International Perspective." BIS CGFS Paper No. 65. <https://www.bis.org/publ/cgfs65.htm>.
- BIS CGFS. 2021. "Changing Patterns of Capital Flows." BIS CGFS Paper No. 66. <https://www.bis.org/publ/cgfs65.htm>.
- Bordo, M., O. Humpage, and A. Schwartz. 2014. "The Evolution of the Federal Reserve Swap Lines since 1962." NBER WORKING PAPERS, No. 20755, December.
- Cetorelli, N., and L. Goldberg. "Global Banks and Their Internal Capital Markets during the Crisis." Federal Reserve Bank of New York LIBERTY STREET ECONOMICS, July 11. <https://libertystreeteconomics.newyorkfed.org/2011/07/global-banks-and-their-internal-capital-markets-during-the-crisis/>.
- Cetorelli, N., L. Goldberg, and F. Ravazzolo. 2020a. "Have the Fed Swap Lines Reduced Dollar Funding Strains during the COVID-19 Outbreak?" Federal Reserve Bank of New York LIBERTY STREET ECONOMICS, May 22. <https://libertystreeteconomics.newyorkfed.org/2020/05/have-fed-swap-lines-reduced-dollar-funding-strains-during-the-covid-19-outbreak/>.
- Cetorelli, N., L. Goldberg, and F. Ravazzolo. 2020b. "How Fed Swap Lines Supported the U.S. Corporate Credit Market amid COVID-19 Strains." Federal Reserve Bank of New York LIBERTY STREET ECONOMICS, June 12. <https://libertystreeteconomics.newyorkfed.org/2020/06/how-fed-swap-lines-supported-the-us-corporate-credit-market-amid-covid-19-strains/>.
- Choi, M., M. Nemeth, and S. Potter. 2020. "Central Banks as Bankers to Each Other." In J. BJORHEIM, ed., ASSET MANAGEMENT AT CENTRAL BANKS AND MONETARY AUTHORITIES. New York: Springer.
- Executives' Meeting of East Asia-Pacific Central Banks (EMEAP). 2020. "Study on U.S. Dollar Liquidity and Funding Dynamics in the EMEAP Region." EMEAP Working Group on Financial Markets, August.

REFERENCES (CONTINUED)

- Gislén, M., I. Hansson, and O. Melander.* 2021. “Dollar Liquidity from the Federal Reserve to Other Central Banks.” *SVERIGES RIKSBANK ECONOMIC REVIEW* 1, March: 27-51.
- Goldberg, L., C. Kennedy, and J. Miu.* 2011. “Central Bank Dollar Swap Lines and Overseas Dollar Funding Costs.” Federal Reserve Bank of New York *ECONOMIC POLICY REVIEW* 17, no. 1 (May): 3-20. https://www.newyorkfed.org/research/staff_reports/sr429.html.
- Goldberg, L., and R. Lerman.* 2019. “The U.S. Dollar’s Global Roles: Where Do Things Stand?” Federal Reserve Bank of New York *LIBERTY STREET ECONOMICS*, February 11. <https://libertystreeteconomics.newyorkfed.org/2019/02/the-us-dollars-global-roles-where-do-things-stand/>.
- Goldberg, L., and F. Ravazzolo.* 2021. “The Fed’s International Dollar Liquidity Facilities: New Evidence on Effects.” Federal Reserve Bank of New York *STAFF REPORTS* 997 (December). https://www.newyorkfed.org/research/staff_reports/sr997.html.
- Goldberg, L., and D.R. Skeie.* 2011. “Why Did U.S. Branches of Foreign Banks Borrow at the Discount Window during the Crisis?” Federal Reserve Bank of New York *LIBERTY STREET ECONOMICS*, April 13. <https://libertystreeteconomics.newyorkfed.org/2011/04/why-did-us-branches-of-foreign-banks-borrow-at-the-discount-window-during-the-crisis/>.
- Liao, G., and T. Zhang.* 2020. “The Hedging Channel of Exchange Rate Determination,” Board of Governors of the Federal Reserve System *INTERNATIONAL FINANCE DISCUSSION PAPERS*, no. 1283. <https://www.federalreserve.gov/econres/ifdp/files/ifdp1283.pdf>.
- McCauley, R. N., and C. R. Schenk.* 2020. “Central Bank Swaps Then and Now: Swaps and Dollar Liquidity in the 1960s.” *BIS WORKING PAPERS*, no. 851. <https://www.bis.org/publ/work851.pdf>.
- Truman, E.* 2016. “The Federal Reserve Engages the World (1970-2000): An Insider’s Narrative of the Transition to Managed Floating and Financial Turbulence.” In M. Bordo and M. Wynne, eds., *THE FEDERAL RESERVE’S ROLE IN THE GLOBAL ECONOMY*. Cambridge: Cambridge University Press.

THE COMMERCIAL PAPER FUNDING FACILITY

Nina Boyarchenko, Richard K. Crump, Anna Kovner, and Deborah Leonard

OVERVIEW

- The Federal Reserve announced the Commercial Paper Funding Facility (CPFF 2020) in March 2020 to support market functioning and to provide a liquidity backstop for the commercial paper market in light of the market disruptions related to the outbreak of COVID-19 and its associated shutdowns.
- Anecdotally, commercial paper investors were unwilling to extend credit to issuers except at very short maturities. This reduction in the availability of credit coincided with increases in yield spreads even for the highest-rated issuers across the maturity spectrum.
- CPFF 2020 marked the reestablishment of a facility that originally operated from October 27, 2008, through February 1, 2010, in response to the global financial crisis (GFC). In both 2008 and 2020 there were concerns about companies' need to fund operations.
- This article focuses on differences in the commercial paper market relative to the last decade and explains the lessons learned from the COVID-19 shock, which had very different dynamics from those of the GFC, when the CPFF was originally used.

In March 2020, commercial paper markets experienced disruptions related to the outbreak of COVID-19 and its associated shutdowns. Investor flows out of money market funds were exacerbated by uncertainty about the impact of COVID-19 on businesses. Anecdotally, commercial paper investors were unwilling to extend credit to issuers except at very short maturities (less than five days). This reduction in the availability of credit coincided with increases in yield spreads even for the highest-rated issuers across the maturity spectrum. The shock to the market negatively affected companies that needed to refinance their maturing commercial paper, exacerbated in 2020 by an increase in the liquidity needed to fund operations disrupted by the pandemic.

In light of these events, on March 17, 2020, the Federal Reserve announced the Commercial Paper Funding Facility (CPFF 2020), designed to support market functioning and to provide a liquidity backstop for the commercial paper market.¹ The CPFF 2020 was a temporary liquidity facility authorized under Section 13(3) of the Federal Reserve Act and backed by \$10 billion in equity from the U.S. Treasury using the Exchange Stabilization Fund. CPFF 2020 marked the re-establishment of a facility that originally operated from October 27, 2008, through February 1, 2010, in

Nina Boyarchenko is head of Macrofinance Studies, Richard K. Crump a financial research advisor, and Anna Kovner the director of Financial Stability Policy Research in the Federal Reserve Bank of New York's Research and Statistics Group. Deborah Leonard is a director in the Bank's Markets Group. Emails: nina.boyarchenko@ny.frb.org, richard.crump@ny.frb.org, anna.kovner@ny.frb.org, deborah.leonard@ny.frb.org.

The views expressed in this article are those of the authors and do not necessarily reflect the position of the Federal Reserve Bank of New York or the Federal Reserve System. To view the authors' disclosure statements, visit https://www.newyorkfed.org/research/epr/2022/epr_2022_CPFF_boyarchenko.

response to the global financial crisis (GFC). In both 2008 and 2020 there were concerns about companies' need to fund operations. However, in 2020, the chief concerns were about the ability of nonfinancial companies to issue commercial paper to fund operations; in 2008, the rollover of asset-backed commercial paper was a key concern.

The CPFF 2020 began its purchase operations on April 14, 2020. Over the course of its life, the facility purchased a total of \$4.285 billion in three-month commercial paper from a range of nonfinancial, financial, and asset-backed commercial paper issuers who used the facility primarily in the first few weeks of its operation. The CPFF 2020's active purchase period ended on March 31, 2021, with no outstanding commercial paper holdings. The facility was dissolved on July 8, 2021, after returning the full sum of the Treasury's equity contribution (plus \$4.8 million in interest earnings) and distributing the facility's \$49.1 million in profits to the Treasury and the New York Fed. Conditions in the commercial paper market improved considerably in the weeks following the announcement that the CPFF 2020 would be established. Spreads returned to more normal levels and companies were once again able to issue paper at longer maturities. The boost to confidence provided by the CPFF 2020, as well as other actions taken by the Federal Reserve in March, appears to have contributed to this improvement in market functioning.

Adrian, Kimbrough, and Marchioni (2011) offer an extensive discussion of the 2008 CPFF, including background on the commercial paper market and the economics of the facility. In this article, we focus on differences in the commercial paper market relative to the last decade, and we elucidate lessons learned from the COVID-19 shock, which had very different dynamics from those of the GFC when the CPFF was originally used. Despite the different origins of the 2008 and 2020 disruptions, as in 2008, the CPFF 2020 served to stabilize conditions in the commercial paper market by providing a backstop to issuers who felt the strains of liquidity shortages in the marketplace. This article proceeds as follows: Section 2 offers background on the commercial paper market, Section 3 on the operation and design of the facility, and Section 4 concludes.

1. BACKGROUND OF THE COMMERCIAL PAPER MARKET

As explained in Adrian, Kimbrough, and Marchioni (2011), the commercial paper (CP) market is used by banks, nonbank financial institutions, and nonfinancial corporations. In addition, some municipalities also issue commercial paper. Although commercial paper is a short-term instrument, it is typically issued as part of an ongoing program. It is often used to finance cash needs that change throughout the year, for example, to fund a large equipment purchase or to smooth lumpy payments from customers. Since CP is traditionally unsecured and not backed by collateral, typically only high-credit-quality firms are able to fund through this market.² Investors in the CP market include prime money funds and other buyers who seek assets with short maturities.

1.1 Recent Evolution of the Commercial Paper Market

Chart 1 reviews the historical patterns of commercial paper outstanding across different types of commercial paper issuers. The commercial paper market peaked in the middle of 2007 with

CHART 1

Commercial Paper Outstanding by Issuer Type

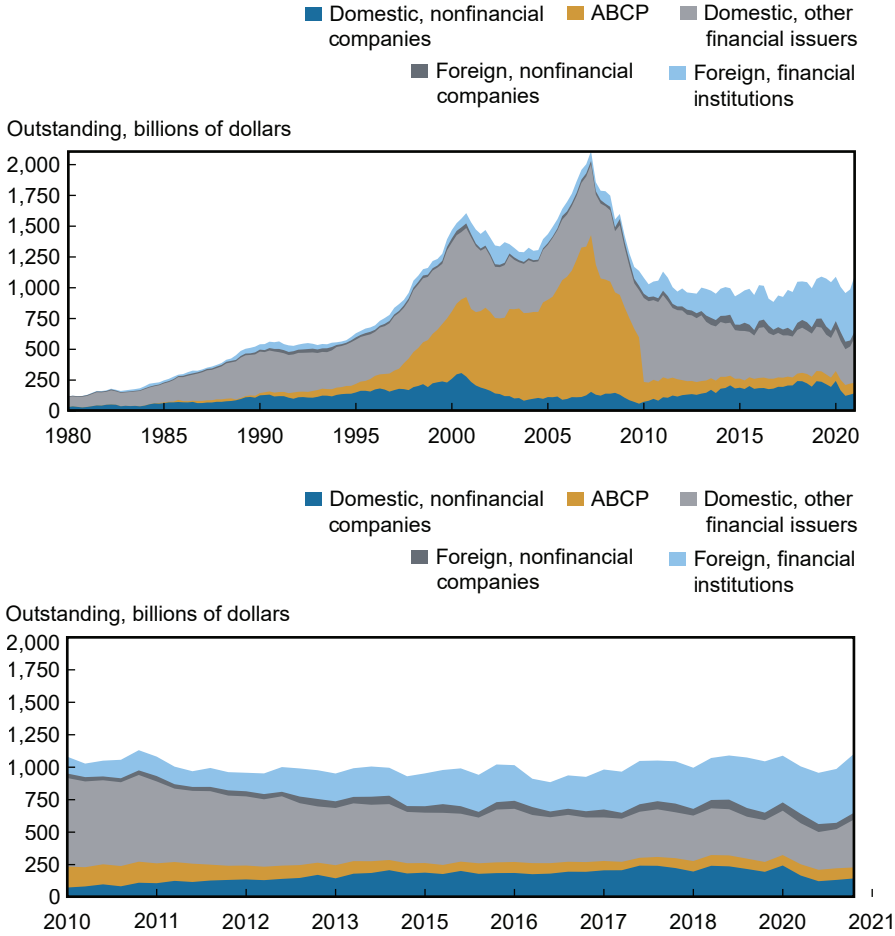

Source: Board of Governors of the Federal Reserve System, Statistical Release Z.1, “Financial Accounts of the United States: First Quarter 2021, Table L.209.”

outstanding paper of \$2.1 trillion. Subsequently, the market has declined substantially, with approximately \$1.1 trillion outstanding in the first quarter of 2020. The biggest change since the financial crisis is the sharp fall in the issuance of asset-backed commercial paper (ABCP), which no longer makes up a large share of the market. Since most ABCP was arranged to provide funding to financial institutions, this means that the share of bank and other financial issuers is much smaller than it was in 2007. In contrast, foreign issuers, in particular, foreign financial institutions, have become an increasingly larger share of the market. Issuance by domestic nonfinancial companies has continued to expand but remains somewhat below the peak of the early 2000s.

Focusing on commercial paper outstanding over the last ten years, the top panel of Chart 2 shows the distribution of the amount outstanding by issuer credit rating. Although the

CHART 2

Commercial Paper Outstanding by Credit Rating and Maturity

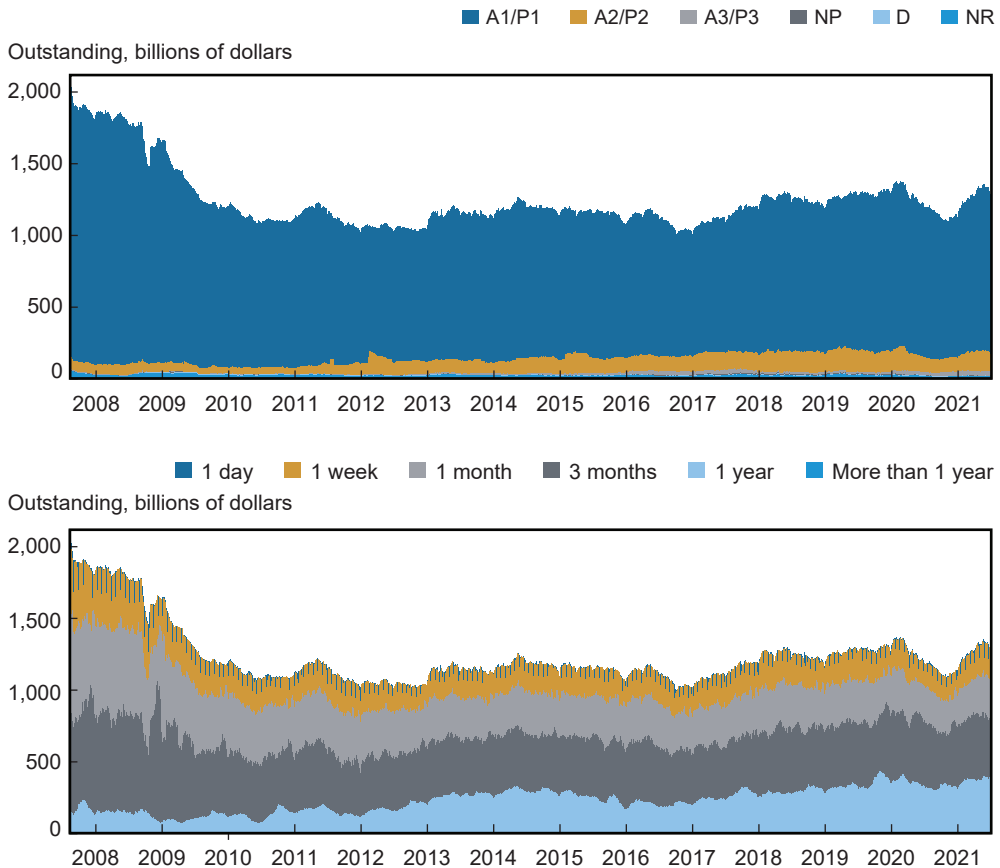

Source: Depository Trust and Clearing Corporation.

Notes: An issuer is designated A1/P1 if its short-term rating is A1/P1/F1 according to at least one major rating agency. Consistent with the eligibility criteria for CPFF 2020, if the issuer is rated by multiple rating agencies, the issuer must receive a short-term rating of A1/P1/F1 from at least two agencies to be included in the ratings category in this chart.

highest-rated category—A1/P1/F1—represents the largest portion of the amount outstanding throughout, the amount outstanding in the slightly riskier A2/P2/F2 credit rating category has been increasing subsequent to the GFC.

The bottom panel of Chart 2 focuses on the amount outstanding by remaining time to maturity. Generally, most issuance has a one-day maturity.³ Outstanding CP at any point in time tends to be mostly of a three-month maturity, and Chart 2 shows that the profile of the commercial paper outstanding had shifted more toward riskier issuers and to longer maturity contracts in the period between the GFC and the start of the pandemic. The largest portion of the amount outstanding in 2020 had remaining time to maturity between one month and three months.

CHART 3
Commercial Paper Holdings by Institution Type

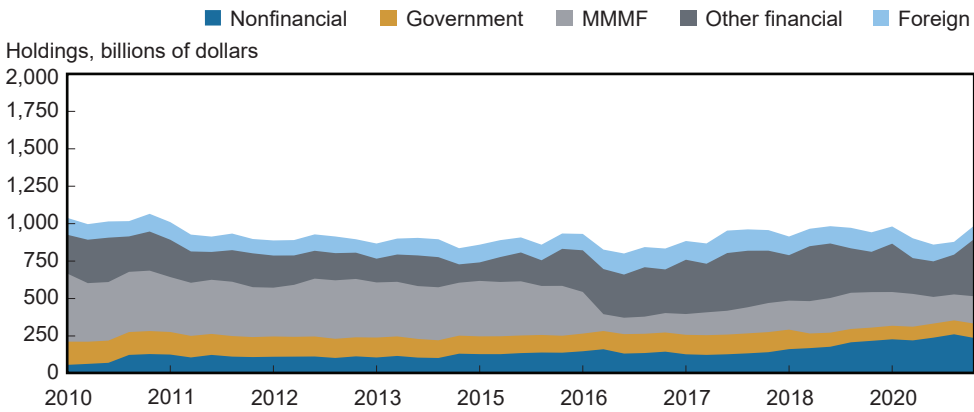
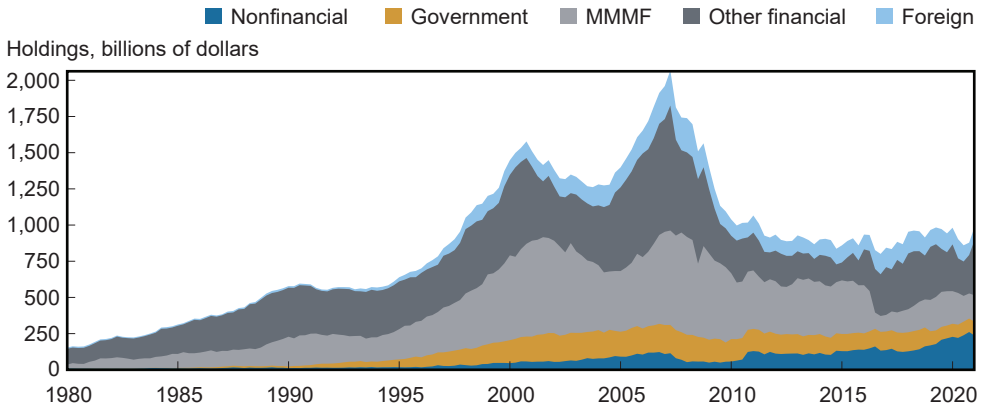

Source: Board of Governors of the Federal Reserve System, Statistical Release Z.1, “Financial Accounts of the United States: First Quarter 2021, Table L.209.”

1.2 Lenders in the Commercial Paper Market

Historically, money market mutual funds (MMMFs) have been the largest single investor in the CP market. One of the biggest changes to the CP investor base came in response to changing MMMF regulation. In 2010, the Securities and Exchange Commission (SEC) first amended Rule 2a-7 to require prime MMMFs to invest in even higher-quality assets with shorter maturities. In 2014, in a further attempt to make the industry more resilient to financial shocks, the SEC approved a new set of rules for prime and muni MMMFs. These rules, which came into effect in October 2016, imposed floating net asset values (NAVs), fund management gates, and the possibility of redemption fees. There was a corresponding shift in assets from prime funds to government funds (see Cipriani and La Spada [2017] for more details), and a decrease in the share of CP outstanding held by MMMFs. Chart 3 characterizes the commercial paper market from the perspective of the investors.

CHART 4
 Spreads on A1/P1 Paper Rose Sharply at the Beginning of March 2020

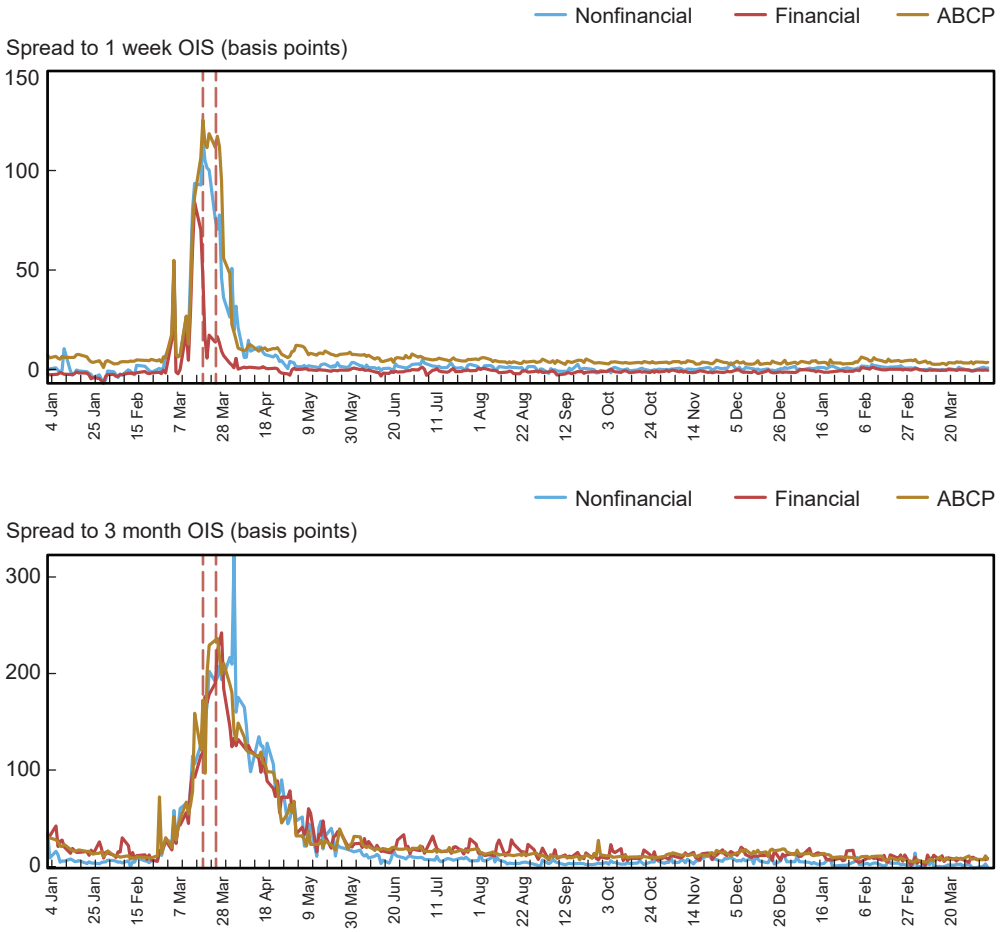

Source: Depository Trust and Clearing Corporation.

Notes: An issuer is designated A1/P1 if its short-term rating is A1/P1/F1 according to at least one major rating agency. If the issuer is rated by multiple rating agencies, the issuer must receive a short-term rating of A1/P1/F1 from at least two agencies. The two vertical red lines correspond to March 17 and March 23.

Since that one-time fall, the share of CP held by MMMFs gradually increased, and holdings by other institutions have been mostly stable since the financial crisis.

1.3 Commercial Paper Market Stress in 2020

Chart 4 plots the recent time series of the spread to the matched-maturity overnight index swap (OIS) for commercial paper issued by A1/P1/F1 nonfinancial, financial, and ABCP issuers. At the beginning of March, spreads on this most highly rated paper increased sharply, particularly for longer maturity commercial paper. In contrast to the GFC, the increase in

spreads was particularly high for nonfinancial issuers. As in past episodes of dysfunction in these markets, a combination of liquidity risk and jump to default risk was manifested, reflecting concerns about the underlying credit quality of issuers based on their potential exposure to ramifications of the COVID-19 pandemic.

Nonfinancial three-month paper spreads to three-month OIS averaged 18 basis points in 2019 and typically were below spreads for financial paper and ABCP. By March 17, 2020, spreads had increased tenfold, subsequently peaking above 300 basis points by the end of March. Anecdotally, concerns were raised about the difficulty of longer-term CP issuance, although no fall in issuance is visible in the data. Such concerns are consistent with the decline in the amount of CP outstanding that began in March 2020, as can be seen in Chart 2.

2. CPFF DESIGN AND OPERATION

The design and operation of the original version of the CPFF is described in detail in Section 3 of Adrian, Kimbrough, and Marchioni (2011). The authors highlight that the effectiveness of the facility as a liquidity backstop was due to its simplicity in usage, compliance with existing market conventions, accessibility to a large cross section of the commercial paper market, minimization of credit risk taken by the Reserve Bank, carefully calibrated pricing, and quick implementation.

The 2020 version of the CPFF (CPFF 2020) sought to capitalize on the previous CPFF by drawing on the legal, trading, investment, custodial, administrative, and risk management blueprints from the prior experience.

2.1 2020 Organization

The design and operation of CPFF 2020 were generally similar to that of the original GFC-era facility.

As in the 2008 program, CPFF 2020 operated through a dedicated funding vehicle—CP Funding Facility II LLC (CPFF II LLC)—that was established solely to purchase eligible three-month commercial paper from eligible issuers, providing a sufficiently long maturity for borrowers to avoid continuous rollover risk. Eligible issuers were highly rated U.S. entities, including nonfinancial corporations, banks, state and local governments, and ABCP programs. CPFF II LLC obtained loans from the Federal Reserve Bank of New York to fund its commercial paper purchases and pledged its assets, including the purchased commercial paper, as collateral to secure any loans.

Also as in the 2008 program, CPFF 2020 operated through existing market structures. Issuers sold paper to the facility through commercial paper dealers, who served as agents between the New York Fed and the commercial paper issuers, drawing on the dealers' existing relationships with the hundreds of issuers in the commercial paper market and their experience underwriting, placing, and making markets in this market. Trade execution was conducted electronically on a platform commonly used for the primary issuance of commercial paper, with straight-through processing requiring little manual intervention. A daily purchase operation with same-day settlement assured issuers that the CPFF could meet any unexpected liquidity need.

Pricing of the facility was again set as a spread to the three-month OIS rate, although the 2020 facility was set at a narrower spread of 110 basis points for top-tier paper and a spread of 200 basis points for tier-two paper (discussed more below). In addition, as in the 2008 facility, issuers paid an upfront registration fee of 10 basis points.

Once again, the New York Fed secured the services of experienced market participants to build the infrastructure needed to run the facility. These included the services of Pacific Investment Management Company, LLC (PIMCO), which served as CPFF II LLC's transaction agent and investment manager, and State Street Bank & Trust Company (State Street), which served as the custodian and accounting administrator. Transactions all cleared through the market's standard clearing mechanisms through the Depository Trust and Clearing Corporation.

The key players in the transaction and flow of funds are explained further in Exhibit 1.⁴

2.2 Differences from the 2008 Facility

Although the overall design and structure of the CPFF 2020 replicated that of the original program, CPFF 2020 operated with several distinct differences, which reflected in part the unprecedented uncertainty and potentially broad impact of the pandemic, initiatives to expand participation and diversification in Federal Reserve programs, and clearer risk-sharing arrangements with the U.S. Treasury. Some of the key differences follow.⁵

- **Downgrade exception:** To minimize the credit risk offered by a backstop facility, the Federal Reserve generally limited purchases to top-tier commercial paper, rated A1/P1/F1 or higher, consistent with 2a-7 fund conventions. Recognizing the uncertainty and concerns about market dynamics as the pandemic spread in the United States, the Fed added a limited-use exception for issuers that met the top-tier eligibility requirement when the facility was announced. These were subsequently downgraded to no lower than A2/P2/F2. Such downgraded issuers would be allowed to make a one-time sale to the facility, effectively allowing them to roll maturing paper with the facility while they worked to secure alternative funding sources. Additional support for corporate bond issuers that were rated investment grade as of March 23 was provided by the Corporate Credit Facilities, which became active later in 2020.
- **Municipal commercial paper:** State and local governments and related entities faced a severe tightening in market conditions because of pandemic-induced uncertainty about revenues and strains on expenditures. On March 23, 2020, to facilitate the flow of credit to municipalities, municipal commercial paper was added as eligible for CPFF purchases, at the same time that the Money Market Liquidity Fund (MMLF) was expanded to accept a wider range of municipal instruments for secondary market purchases. Both actions provided support before the Federal Reserve and Treasury Department announced in early April the establishment of a \$500 billion Municipal Liquidity Facility to support state and local governments more directly.
- **Pricing structure:** While the 2008 version of the program offered different spreads for the prices at which the facility would buy unsecured versus asset-backed commercial paper (and considered a credit surcharge for paper that did not carry a government guarantee), CPFF 2020 offered to purchase both unsecured and asset-backed commercial paper at the same price. The initial terms and conditions stated that the price of Tier 1 paper would be the three-month OIS rate plus 200 basis points, which was equal to the all-in pricing offered in the 2008 program. Downgraded paper would be subject to a

EXHIBIT 1
Schematic of Key Linkages in the CPFF

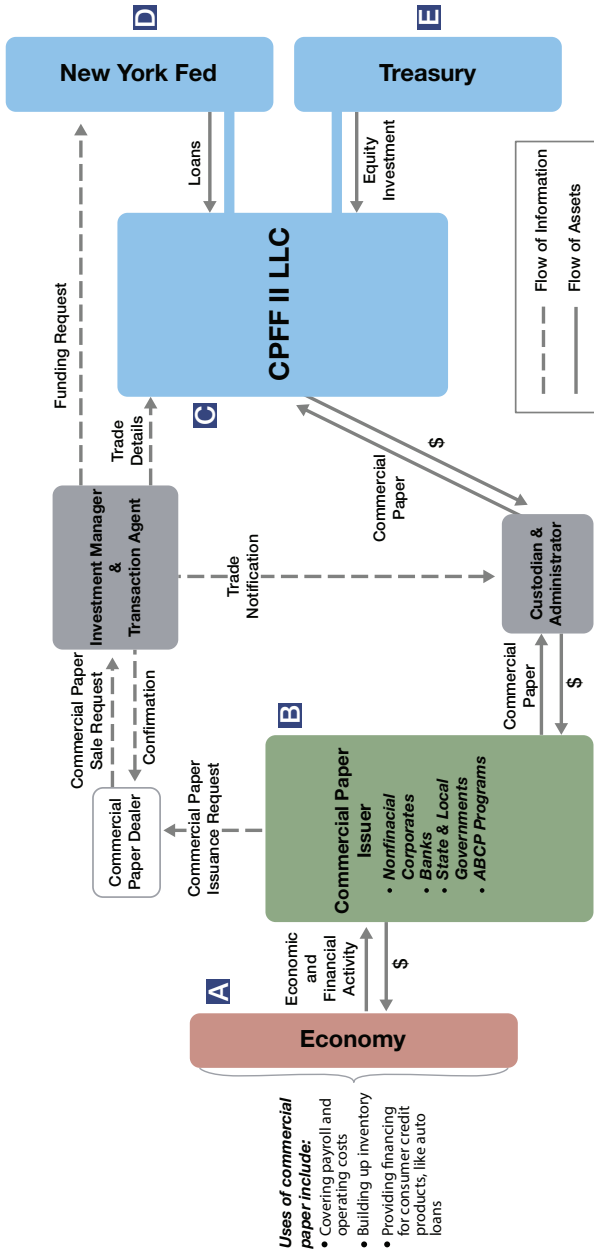

Uses of commercial paper include:

- Covering payroll and operating costs
- Building up inventory
- Providing financing for consumer credit products, like auto loans

Key Entities

- A. Commercial paper is a short-term IOU used to finance a wide range of economic activity, supplying funding for the operational needs of businesses and municipalities. Commercial paper can help firms cover payroll and other operating costs, build up inventories, and provide financing for assets like auto loans.
- B. Issuers of commercial paper can register to sell their paper to the CP Funding Facility II LLC (CPFF II LLC). Eligible issuers are highly rated U.S. entities, including nonfinancial corporations, banks, state and local governments, and asset-backed commercial paper (ABCP) programs.
- C. The CPFF II LLC is a dedicated funding vehicle established solely to implement the CPFF by purchasing eligible commercial paper from eligible issuers.
- D. The New York Fed manages the CPFF II LLC and makes loans to fund its commercial paper purchases. It has retained vendors to assist in managing the CPFF II LLC's activities (Investment Manager & Transaction Agent), and to serve as custodian and administrator of the CPFF II LLC's assets (Custodian & Administrator).
- E. The U.S. Treasury has made an equity investment in the CPFF II LLC to help absorb potential losses.

higher price. The spread on the Tier 1 price was subsequently lowered to 110 basis points (and the spread for Tier 2 paper was set at 200 basis points), in order to be more consistent with pricing offered for other facilities active at the same time and in consideration of prevailing market conditions.

- **Equity capital:** The U.S. Treasury, using the Exchange Stabilization Fund, provided a \$10 billion equity investment in the CPFF II LLC. While the original CPFF did not have formalized credit protection, ensuring this arrangement at inception helped to secure the facility to the Federal Reserve’s satisfaction—a requirement for all 13(3) lending—and reinforced cooperation between the Federal Reserve and Treasury in addressing the urgent needs of this crisis. The size of the equity investment for the facility was calibrated based on historical A1/P1/F1 extreme downgrade probabilities.⁶ This equity was in addition to the 10 basis point registration fee that issuers paid upfront, which, together with any earnings, would absorb potential credit losses.
- **Expanded ratings agencies:** CPFF 2020, like the 2008 version, was launched with program terms that would accept credit ratings only from Fitch Ratings, Inc., Moody’s Investors Service, Inc., and S&P Global Ratings. On May 26, 2020, the Federal Reserve expanded the set of nationally recognized statistical rating organizations (NRSROs) whose ratings would be accepted in determining the eligibility of commercial paper—adding DBRS, Inc., Kroll Bond Rating Agency, Inc., and only with respect to insurance companies, A.M. Best Rating Services, Inc.—to the extent the issuer also had a qualifying rating from one of the original three NRSROs.
- **Expanded counterparties:** Finally, while both versions of the CPFF were launched with a structure that relied on primary dealers as the intermediaries between issuers and the facility, on July 23, 2020, the Federal Reserve launched an initiative to broaden the set of broker dealers who would be eligible to transact with the CPFF. This initiative was expected to increase the operational capacity of the facility while supporting equal opportunity for and diversity in the operation of the facility. Between September 9, 2020, and February 4, 2021, seven nonprimary commercial paper dealers who met designated eligibility requirements (including size restrictions, transaction capabilities, financial conditions, compliance controls, and equal opportunity and diversity efforts), were added to the program as CPFF dealers.

Other terms of the program, including issuer capacity limits and registration provisions, were the same as those of the 2008 program. Counterparty risk management also functioned essentially the same, with penalty pricing associated with lending rates analogous to setting haircuts on a nonrecourse loan.

3. IMPACT OF THE FACILITY

As shown in Chart 4, for the shortest maturity issuances, spreads to one-week OIS on one-week A1/P1 paper started declining immediately upon announcement of the facility on March 17: The spread on nonfinancial commercial paper declined from 117 basis points on March 17 to 11 basis points on April 14 (when the facility commenced purchases), and the spread on financial commercial paper declined from 46 basis points on March 17 to 1 basis point on April 14. The

CHART 5

A2/P2 Market Functioning Also Improves after CPFF Announcement

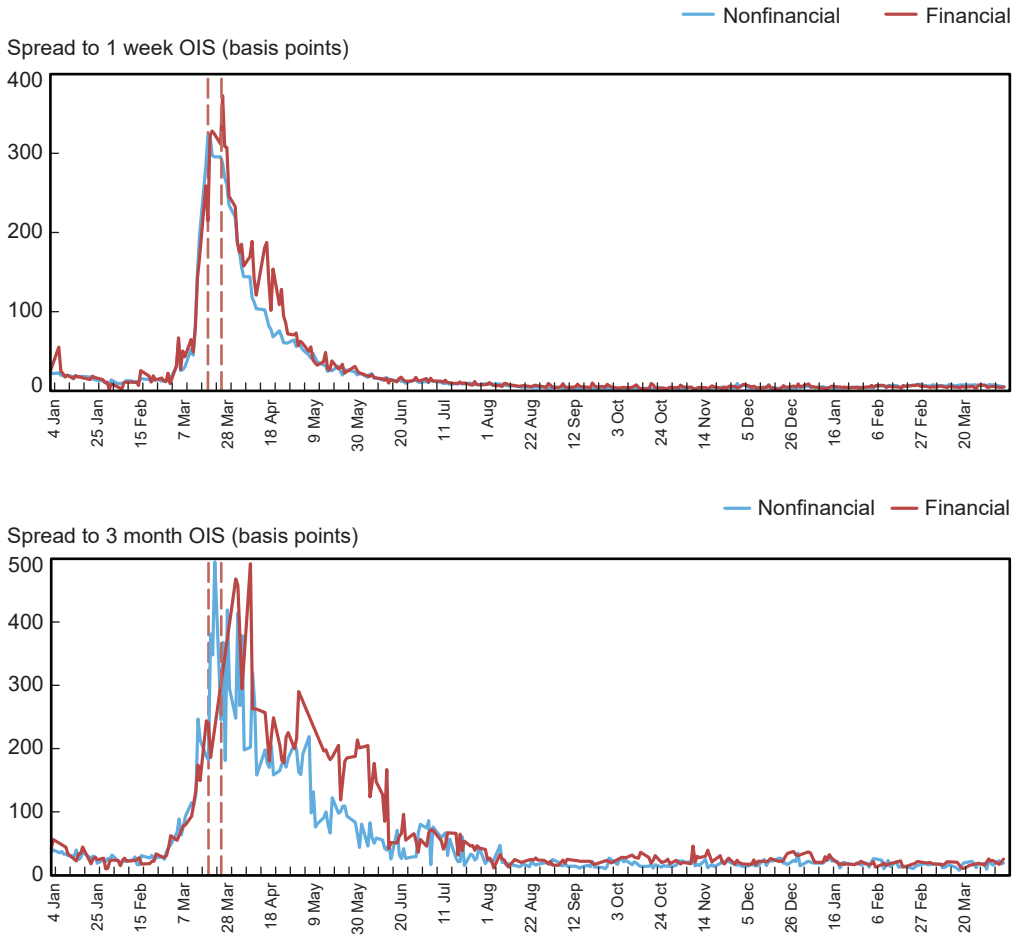

Source: Depository Trust and Clearing Corporation.

Notes: An issuer is designated A2/P2 if its short-term rating is A2/P2/F2 according to at least one major rating agency. If the issuer is rated by multiple rating agencies, the issuer must receive a short-term rating of A2/P2/F2 from at least two agencies. The two vertical red lines correspond to March 17 and March 23.

response of spreads on longer maturity commercial paper continued to rise after the facility announcement, with the spreads to three-month OIS on three-month A1/P1 nonfinancial commercial paper peaking at 322 basis points on April 1, before declining to 125 basis points by April 14. Similarly, the spreads to three-month OIS on three-month A1/P1 financial commercial paper started to decline on March 26 from 242 basis points to 98 basis points on April 14.

While the facility only accepted commercial paper from issuers rated A1/P1 as of the facility announcement date, by stabilizing the A1/P1 market, the facility has had a positive impact on market functioning and liquidity for lower-rated issuers as well. Chart 5 shows spreads to maturity-matched OIS for A2/P2 commercial paper.

As with the A1/P1 market, the shortest maturity spreads reacted almost immediately: The spread on nonfinancial commercial paper declined from 322 basis points on March 17 to 93 basis points on April 14, and the spread on financial commercial paper declined from its peak of 373 basis points on March 24 to 187 basis points on April 14. The reaction of longer maturity spreads was less pronounced, with a modest 50-basis-point decline in the spread on nonfinancial three-month paper over the period from March 17 to April 14. Indeed, the bottom panel of Chart 5 shows that the spreads on three-month A2/P2 paper only went back to pre-pandemic levels toward the end of the summer of 2020. Thus, although the CPFF announcement helped to ameliorate stresses throughout the commercial paper market, the response of securities not eligible for direct purchases was more muted.

Inspecting the A1/P1 nonfinancial issuers in greater detail, we can examine whether market pricing for issuers in industries more likely to be directly affected by the COVID epidemic—such as airlines, department stores, restaurants, and hotels—has evolved in the same way as for issuers less likely to be directly affected. In particular, we group issuers into “most affected” and “less affected” based on the declines in payroll employment between January and April 2020 at the three-digit NAICs industry level, with the issuers most affected defined as those in industries that declined by 15 percent or more. Chart 6 shows that, although spreads on one-week paper have declined for both sets of issuers since the facility announcement, the initial decline in spreads for more directly affected issuers was more modest. It was not until the economic outlook improved during the summer of 2020 that the spreads on the issuers most affected caught up to the spreads on the issuers less affected. Indeed, toward the end of 2020, spreads on the issuers most affected were below those of the issuers less affected. However, as can be seen in the bottom panel of Chart 6, issuance by the issuers most affected has remained sluggish, while issuance by the issuers less affected has surpassed pre-pandemic levels.

4. LESSONS LEARNED

Three main lessons were learned from the CPFF 2020: different crises require different actions, facility design needs to evolve with the market and the crisis, and experience speeds response.

First, considering the nature of the crisis, the 2008 dislocations in the commercial paper markets were driven by the financial sector, while the 2020 market dislocations were seen more at nonfinancial corporations. In addition, issuance in this market had moved away from ABCP. Therefore, CPFF 2020’s design did not differentiate between financial and nonfinancial issuers in pricing or other terms. In both episodes, the establishment of a backstop facility was effective in restoring normal market functioning.

Second, specific terms and conditions need to reflect the particulars of the given economic environment. Design elements that were substantially similar to those of the original program were adapted to the new situation (as discussed in the previous section, including a downgrade exception and the inclusion of muni issuers), and other elements that remained the same elicited different reactions (for example, some reactions from market participants about registration fees, which had the same structure as before, faced more resistance this time than last). Moreover, in considering the appropriate pricing and amount of required equity, the Fed had to weigh the high credit quality and rare historical defaults of the market against the

CHART 6
 Spreads on One-Week Paper Decline for Different Types of Nonfinancial Issuers

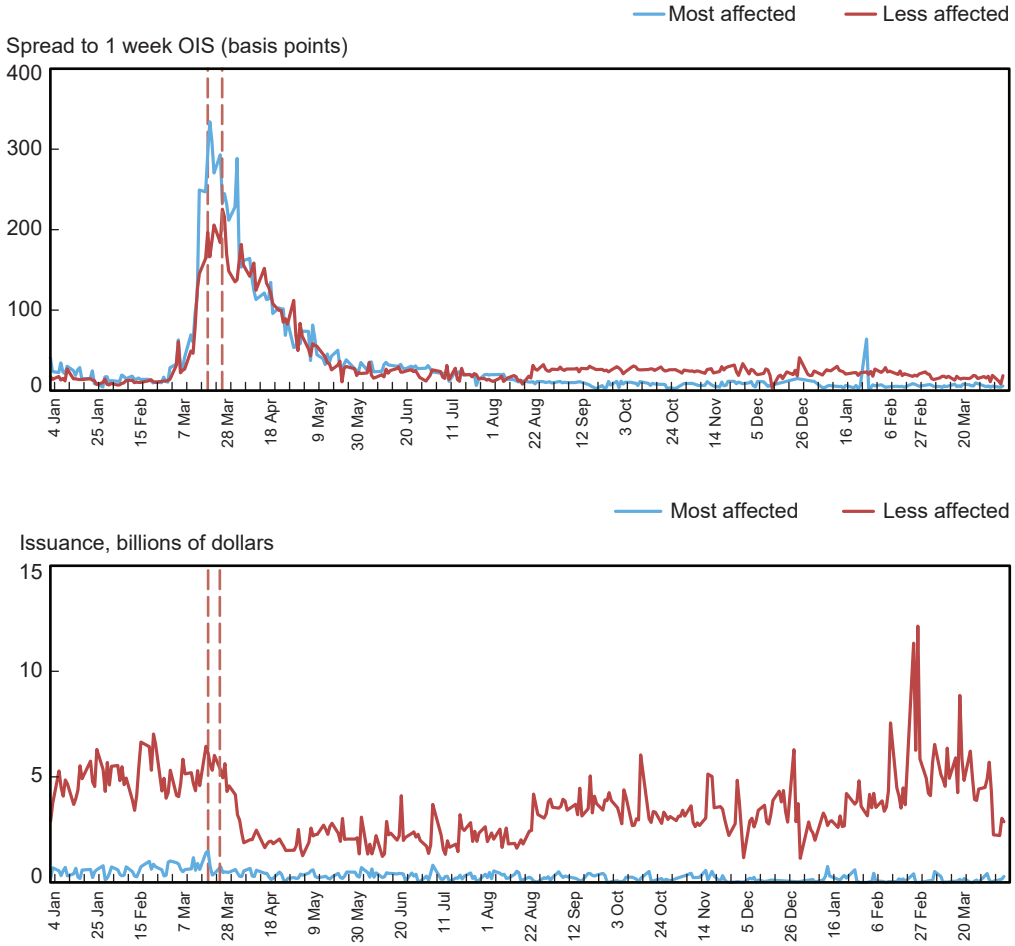

Source: Depository Trust and Clearing Corporation.

Notes: The two vertical red lines correspond to March 17 and March 23. The issuers most affected are those in industries with a decline in payroll employment of 15 percent or more between January and April 2020.

specific circumstances under which the facility might be needed. However, ensuring pricing such that usage would naturally decline as conditions normalize is a key design feature.

The third lesson learned is the importance of operational readiness in setting up the facility and the importance of a quick and comprehensive response. It was much easier to revive a prior facility than to build one from scratch. The task of setting up CPMF 2020 was eased by the ability to make use of structure and implementation lessons from the 2008 CPMF. This is particularly important because the speed with which the Federal Reserve was able to announce the MMLF, CPMF, PDCF, along with the reduction in the policy rate and the primary credit rate all supported critical access to credit to support employment.

Usage of CPFF 2020 was much lower than in 2008, with a maximum outstanding of the original CPFF at nearly \$350 billion and the maximum outstanding of CPFF 2020 at \$4.3 billion. However, facility usage is not a measure of its success, and this too is an important lesson: Just because a facility is not used in scale doesn't mean that the facility was not useful. The existence of a backstop is sufficient to prevent runs from happening, ensuring access to funding to pay employees or other liquidity needs. The relatively low usage reflects the quicker speed of the market recovery in 2020 relative to 2008-09, as well as differences in market structure over the past decade, the differing nature of the two crises, and differences in banks' high levels of capital and their ability to provide back-up credit. The rapid recovery in markets and relatively low usage reflected the importance of this timely response and the availability of backstops in times of uncertainty. CPFF 2020 was one of numerous large-scale actions announced by the Federal Reserve to support the flow of credit to households and businesses during the pandemic—initially with facilities directed at short-term markets that had been used in the past, and then new credit programs that supported other critical segments of the market and the economy.

5. CONCLUSION

The sudden deterioration in commercial paper markets in March 2020 was similar to that of the financial crisis, and CPFF 2020 made available similar liquidity of last resort to this critical funding market, allowing the market to resume activity with relatively little usage of the facility. This reinforces the idea that a facility need not be used to be successful. One key difference was in the extent of the dislocations at financial as compared with nonfinancial corporations. Another difference was the aggressiveness and comprehensiveness of the policy response: Complementary programs were launched at the start of the crisis, and then subsequent to the CPFF announcement, the Federal Reserve announced additional corporate credit interventions targeting corporate bonds and municipal debt. It is hard to know to what extent those facilities contributed to the success of CPFF 2020.

With the CPFF 2020, the Fed has acted as a liquidity provider of last resort for the second time in commercial paper markets. Without changes to the ecosystem of money markets, it seems likely that this role will continue to be required when very large shocks affect financial markets and have the potential to amplify declines in economic activity.

NOTES

Acknowledgments: The authors thank Mark Carlson, Raymond Check, Dina Marchioni, and an anonymous referee for substantial comments and contributions. Some sections of this article are based on Liberty Street Economics blog posts published in 2020. Dorinda Ma and Rajesh Rao provided research assistance.

¹ The Federal Reserve also announced the Primary Dealer Credit facility on March 17, 2020, as well as supervisory guidance on the use of capital and liquidity buffers for banks. For a comprehensive list of the Federal Reserve's actions in response to the pandemic, see Board of Governors of the Federal Reserve System, "Coronavirus Disease 2019 (COVID-19)," <https://www.federalreserve.gov/covid-19.htm>. They are also described in Clarida, Duygan-Bump, and Scotti (2021) as well as in this special issue.

² An exception to this is asset-backed commercial paper, which played a large role in the 2008 financial crisis.

³ Note, however, that since one-day paper, by definition, matures within a day, there is very little amount outstanding of one-day commercial paper, as reflected in the thin blue area in the bottom panel of Chart 2.

⁴ The exhibit is a stylized diagram that does not include several other players in the full end-to-end clearing and settlement process.

⁵ For a comprehensive overview of terms and conditions, frequently asked questions, announcements, agreements, and operational details relating to the CPFF, see Federal Reserve Bank of New York, "Commercial Paper Funding Facility," <https://www.newyorkfed.org/markets/commercial-paper-funding-facility>.

⁶ Specifically, the historical worst-case frequency of downgrade to nonprime within one year. Note that, historically, no A1/P1/F1 paper has defaulted.

REFERENCES

- Adrian, T., K. Kimbrough, and D. Marchioni.* 2011. “The Federal Reserve’s Commercial Paper Funding Facility.” Federal Reserve Bank of New York ECONOMIC POLICY REVIEW (May). <https://www.newyorkfed.org/medialibrary/media/research/epr/11v17n1/1105adri.pdf>
- Cipriani, M., and G. La Spada.* 2017. “Investors’ Appetite for Money-Like Assets: The Money Market Fund Industry after the 2014 Regulatory Reform.” Federal Reserve Bank of New York STAFF REPORTS, no. 816, June (revised June 2018). https://www.newyorkfed.org/medialibrary/media/research/staff_reports/sr816.pdf
- Clarida, R., B. Duygan-Bump, and C. Scotti.* 2021. “The COVID-19 Crisis and the Federal Reserve’s Policy Response.” Federal Reserve System Board of Governors FINANCE AND ECONOMICS DISCUSSION SERIES (FEDS) (June).

THE PRIMARY DEALER CREDIT FACILITY

Antoine Martin and Susan McLaughlin

OVERVIEW

- The Federal Reserve established a new Primary Dealer Credit Facility (PDCF) in March 2020 to enable primary dealers to support smooth market functioning and facilitate the availability of credit to businesses and households.
- The PDCF was one of many facilities introduced by the Federal Reserve to support the U.S. economy in the face of deteriorating conditions in the market due to the coronavirus pandemic.
- The Federal Reserve had established a similar facility in March 2008 after the near-bankruptcy of Bear Stearns to help restore the orderly functioning of the market and prevent the spillover of distress to other financial firms.
- This article provides an overview of the 2020 PDCF and compares it to the 2008 facility.

On March 17, 2020, in response to deteriorating conditions in the market for tri-party repo financing, the Federal Reserve announced that it would establish a new Primary Dealer Credit Facility (PDCF) to enable primary dealers to support smooth market functioning and facilitate the availability of credit to businesses and households.¹ The PDCF started offering overnight and term funding with maturities of up to ninety days on March 20, 2020; it ceased extending credit on March 31, 2021.

A similar facility had been established in March 2008, following the near-bankruptcy of Bear Stearns, to help restore the orderly functioning of the market and to prevent the spillover of distress to other financial firms.² After the bankruptcy of Lehman Brothers in October, the 2008 PDCF was expanded by broadening the types of collateral that could be financed at the facility.

In this article, we provide an overview of the 2020 PDCF and compare it to the 2008 version.

Antoine Martin is a financial research advisor for Financial Stability Policy Research in the Research and Statistics Group and Susan McLaughlin is head of Treasury Debt Financing and Emergency Lending Facilities in the Markets Group at the Federal Reserve Bank of New York. Emails: antoine.martin@ny.frb.org, susan.mclaughlin@ny.frb.org.

The views expressed in this article are those of the authors and do not necessarily reflect the position of the Federal Reserve Bank of New York or the Federal Reserve System. To view the authors' disclosure statements, visit https://www.newyorkfed.org/research/epr/2022/epr_2022_PDCF_martin.

1. BACKGROUND

Primary dealers are trading counterparties of the Federal Reserve Bank of New York that support its implementation of monetary policy. Primary dealers are the largest market makers in the U.S. government securities markets;³ they help provide liquidity in the market for government securities. Primary dealers also act as market makers for other fixed-income securities and for equity securities. Most primary dealers are securities broker-dealers rather than depository institutions; accordingly, they do not have direct access to the discount window, even if they are affiliated with a bank holding company.

The coronavirus pandemic led to extreme uncertainty regarding the future path of the economy. This uncertainty, in turn, led to considerable market volatility for a wide range of assets: investors tried to reduce their level of debt and risk positions and build up cash reserves.⁴ Markets for nongovernment securities were also affected, because selling pressures strained financial intermediaries' ability to make markets for buyers and sellers of securities. By mid-March, repo market conditions had deteriorated so sharply that the Board of Governors of the Federal Reserve determined that circumstances were "unusual and exigent." In response, the Federal Reserve established the PDCF, with the approval of the Treasury Secretary, under the authority provided in Section 13(3) of the Federal Reserve Act.

Funding extended to primary dealers under the PDCF took the form of repurchase agreement transactions that settled through tri-party repo.⁵ Eligible assets consisted of a broad range of investment-grade debt securities, including commercial paper and municipal bonds, and a broad range of equity securities. PDCF loans were made with recourse to the firm's assets in the event of a borrower default. This approach contrasts with some of the Federal Reserve's non-recourse facilities for which the Treasury Department provided capital to absorb any initial losses experienced.

The PDCF was designed as a discount window-like program for broker-dealers, who are not eligible to borrow at the discount window. The rate charged for PDCF loans was set equal to the discount window's primary credit rate. The methodologies used to price and margin collateral pledged to the PDCF were based on those utilized for collateral pledged by banks to the discount window; however, they have less granularity, which reflects some operational constraints in the tri-party repo clearing bank infrastructure. The set of assets eligible for pledge to the PDCF generally aligned with the assets eligible for pledge to the discount window. However, the PDCF accepted a few security types—such as equities—that are not eligible at the discount window because they are not or cannot be held by banks; these security types are routinely funded by primary dealers in the tri-party repo market due to the critical role they play in making markets in these instruments.⁶

2. EXPERIENCE WITH THE PDCF

Lending rose quickly after the PDCF's launch, and the weekly average of outstanding loans peaked at more than \$35 billion for the week ending April 15, as shown in Chart 1. Outstanding loans remained in the \$30–35 billion range for a few weeks before decreasing as market conditions improved.

CHART 1
Total Loans Outstanding at the PDCF

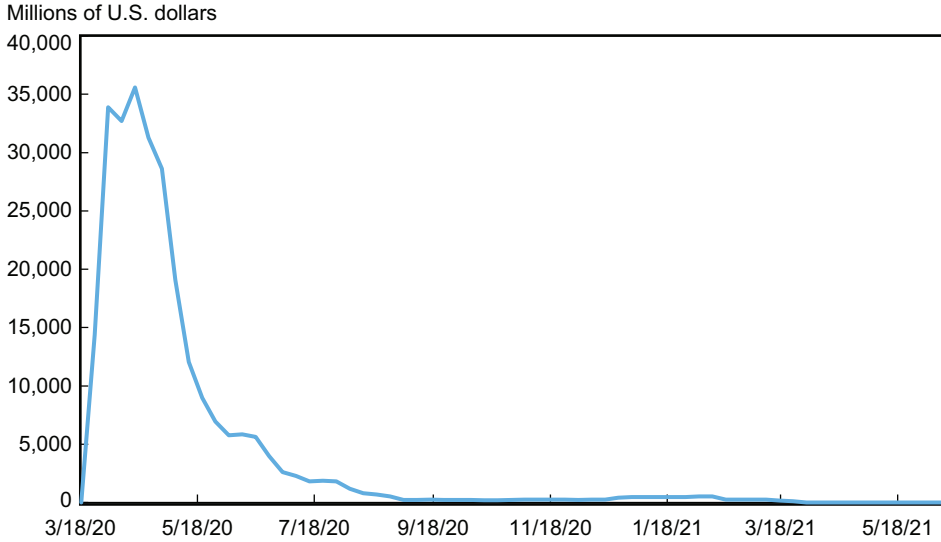

Source: Board of Governors of the Federal Reserve System, Statistical Release H.4.1., “Factors Affecting Reserve Balances.”

CHART 2
Spreads since PDCF Launch

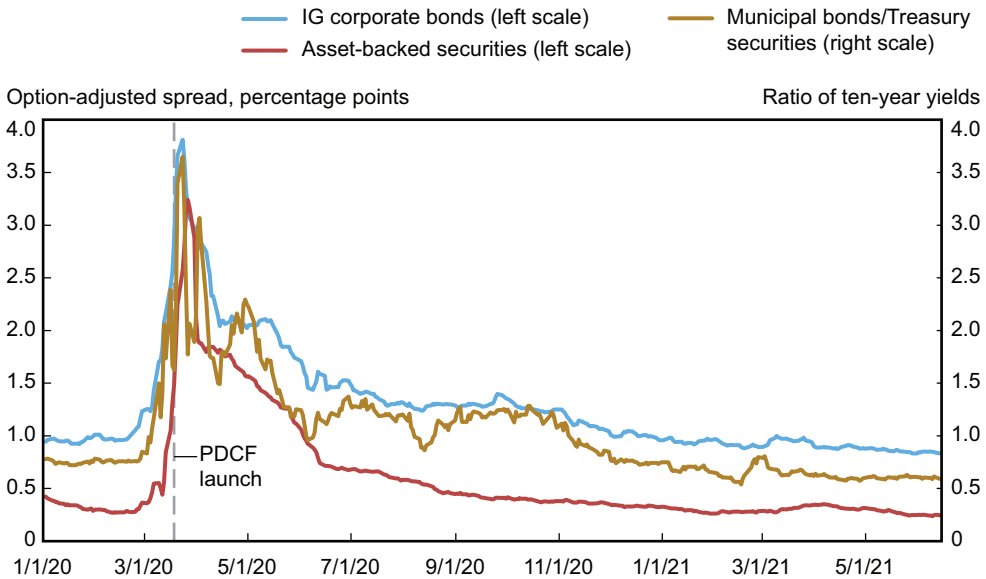

Sources: Bloomberg L.P.; Barclays Capital Aggregate Bond Index.

Notes: The option-adjusted spreads for investment-grade (IG) corporate bonds and asset-backed securities are calculated for the respective Barclays Aggregate Bond Index benchmark indexes relative to Treasury securities. The municipal debt curve presents the yield on ten-year municipal bonds as a ratio to the yield on ten-year U.S. Treasury securities.

The bulk of the assets financed in the PDCF were corporate and municipal debt, as well as asset-backed securities and commercial paper. These are the asset classes that were experiencing considerable price volatility and selling pressure in early March 2020. Market conditions improved markedly after the introduction of a variety of Federal Reserve interventions, including the PDCF.⁷ Although it is difficult to measure the contribution of each individual facility to improving market functioning, the interventions together had a beneficial effect. Both cash and funding market pressures in PDCF-eligible asset classes diminished after the PDCF launched. Chart 2 represents spreads in the cash market for some of the asset types funded in the PDCF; Charts 3 and 4 present tri-party repo funding spreads for several PDCF-eligible asset classes.

CHART 3

One-Month Repo Spreads to IOER for Select PDCF-Eligible Collateral

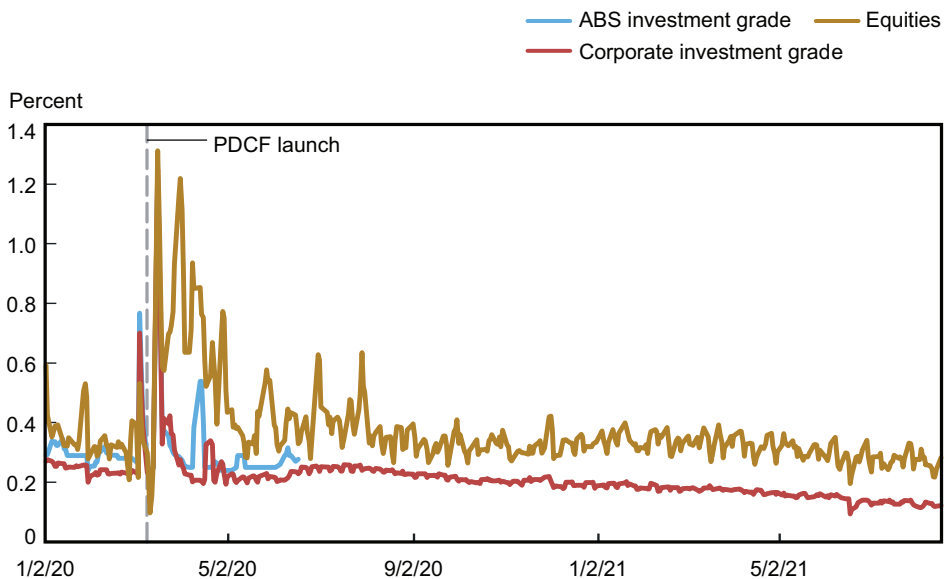

Sources: BNY Mellon; Bloomberg L.P.; New York Fed analysis.

Notes: Three-day rolling average spread of one-month tri-party repo rates over IOER for indicated collateral types. ABS is an asset-backed security; IOER is the interest rate on excess reserves.

3. COMPARISON WITH THE 2008 PDCF

The Federal Reserve initially established the PDCF in March of 2008, following severe strains in the tri-party repo market that were associated, in part, with Bear Stearns' troubles.⁸ The economic stress and the drivers of financial market disruptions were very different in March 2020 than in 2008. In 2008, the repo market stress that led to the creation of the PDCF was largely driven by concerns about the exposure of some dealers to subprime mortgages. In contrast, as noted above, market participants' broad response to the emerging pandemic and the uncertainty it created was to liquidate holdings to build

CHART 4

Three-Month Repo Spreads to IOER for Select PDCF Eligible Collateral

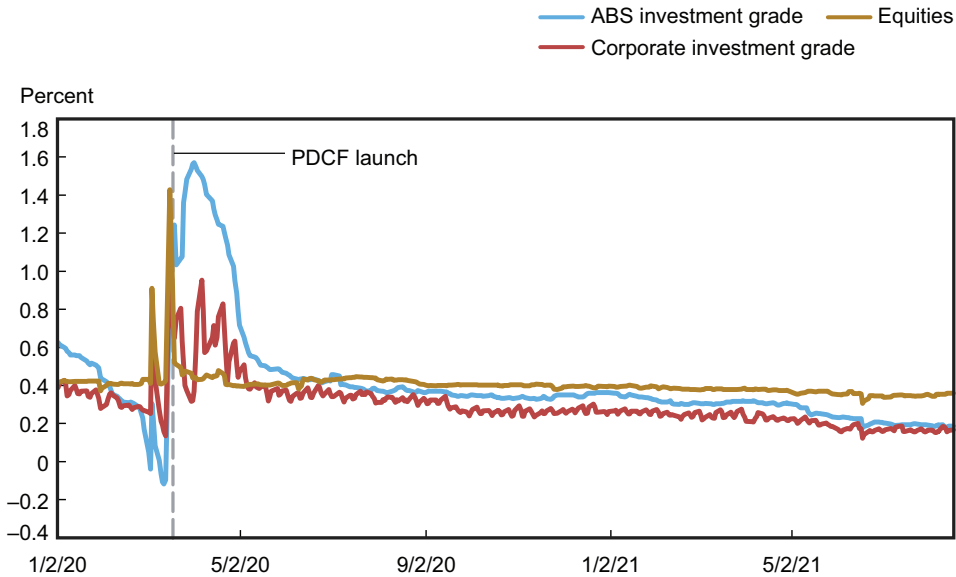

Sources: BNY Mellon; Bloomberg L.P.; New York Fed analysis.

Notes: Three-day rolling average spread of three-month tri-party repo rates over IOER for indicated collateral types. ABS is an asset-backed security; IOER is the interest rate on excess reserves.

up large cash positions. The 2020 PDCF was implemented in response to the stress that arose in a wide range of financial markets; the PDCF's purpose was to support credit intermediation by primary dealers and thereby facilitate the availability of credit to businesses, households, and municipalities.

Following its inception in March 2008, usage of the original PDCF increased to approximately \$40 billion, before decreasing to zero by mid-2008, as shown in Chart 5. This \$40 billion level is roughly comparable in current dollar terms to the peak usage of the 2020 PDCF. In September 2008, following the bankruptcy of Lehman Brothers, usage of the original PDCF increased to more than \$140 billion, as seen on Chart 5. This peak is much higher than the peak use of the 2020 PDCF. The range of securities eligible for the PDCF post-Lehman Brothers, however, was much broader than the range of securities accepted as collateral at the 2020 PDCF, making comparisons difficult.⁹

The volume of privately issued securities financed in the tri-party repo market was markedly lower in 2020 than in 2008, partly as a result of the impact of tri-party repo market reform and bank regulatory changes. Total tri-party repo financing of nongovernment securities was approximately \$340 billion in March 2020, compared to \$600 billion in August 2008.¹⁰ Accordingly, it is interesting to observe how similar the level of borrowing was between 2008 and 2020, in light of the decline in market size over that period.

One noteworthy difference in the design of the 2020 version of the program was the extension of the term of financing. In the 2008 version, loans were only granted for an overnight term. The 2020 version of the PDCF made loans for terms up to a maximum of ninety days,

CHART 5

PDCF Loans Outstanding, 2008 vs. 2020

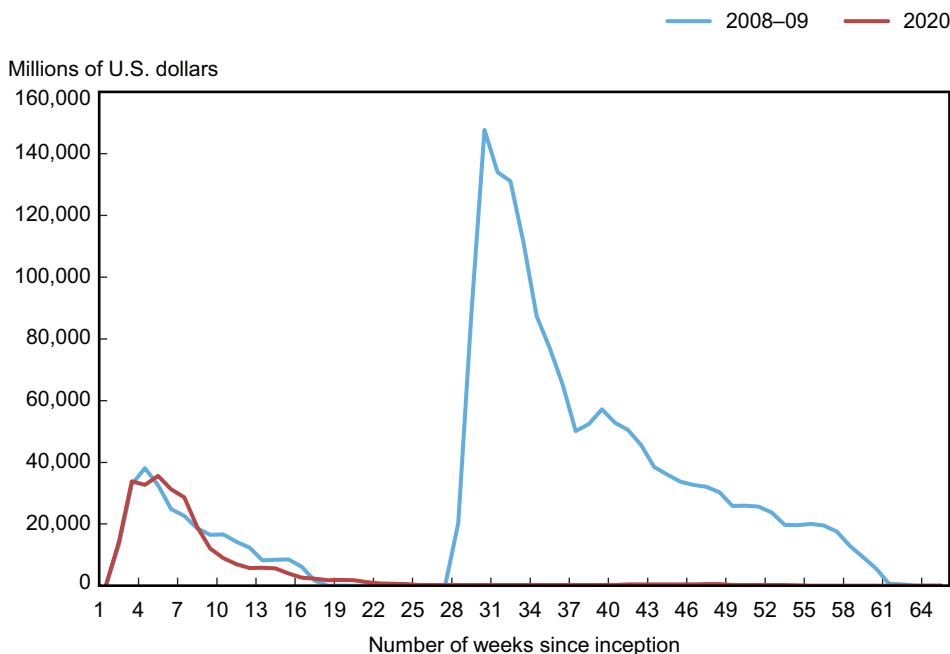

Source: Board of Governors of the Federal Reserve System, Statistical Release H.4.1., “Factors Affecting Reserve Balances.”

which aligned it with the term primary credit program for banks announced on March 15, to respond to the disruption to the functioning of term funding markets. As noted in the Federal Reserve System FAQs about discount window lending, this design feature made PDCF loans compliant with the Liquidity Coverage Ratio (LCR) by (1) providing funding at tenors beyond 30 days and (2) allowing borrowers to prepay or renew the loans at will.¹¹

As shown in Charts 3 and 4, stress was evident in term repo funding rates for nongovernment securities in early 2020. Data for usage of the program demonstrate that a considerable share of the demand for PDCF financing was for term funding. Of the dollars loaned, 96 percent were for tenors of one week or longer; 41 percent of loans were made for tenors of more than three months (eighty-four days). The change in loan tenor appears to have positioned the 2020 version of the PDCF as a more effective tool to stabilize tri-party repo market functioning than an overnight-only facility.

4. WAS THE PDCF EFFECTIVE?

Some academic work suggests that the PDCF was effective in improving market functioning. Carlson and Macchiavelli (2021) find evidence that the PDCF enhanced the ability of primary dealers to provide intermediation services, such as facilitating the issuance of commercial

paper (CP) and negotiable certificates of deposit (CD). They also show that CP and CD issuers benefited indirectly from the PDCF, because these issuers were able to issue in greater size or at lower cost when the CP or CD that was issued was pledged as collateral to the PDCF by a dealer.

O'Hara and Zhou (2021) study how the PDCF and the secondary market corporate credit facility affected dealer behavior. They find that after the introduction of the PDCF, dealers almost immediately reverted to accumulating inventories. Such improvement is consistent with the Federal Reserve's actions to ease funding liquidity problems via direct lending. They also show that transaction costs began to fall and that block trade effects subsided.

There is less work studying the effectiveness of the 2008 PDCF, although Yang (2020) notes that the 2008 PDCF is generally considered to have been successful, based on a review of the existing literature focusing on reactions in spreads. Adrian and Schaumburg (2012) argue that the sharp drop-off in the 2008 PDCF usage following the peak can be seen as evidence of its effectiveness. Indeed, the PDCF was priced at a backstop rate, so that its usage would be unattractive when normal market conditions would be restored. This is also the case for the 2020 PDCF; in that case, usage also declined quickly after the peak. That said, as noted, multiple facilities were introduced in both 2008 and 2020 to restore market functioning, and it is difficult to isolate the effect of the PDCF given that it provided a backstop for some of the asset classes backstopped by other programs introduced in 2020.

5. TO SUM UP

The PDCF was one of many facilities introduced by the Federal Reserve to support the U.S. economy in the face of the coronavirus pandemic. The PDCF helped primary dealers to support smooth market functioning and facilitate the availability of credit to businesses and households in their capacity as market makers for corporate, consumer, and municipal obligations.

NOTES

Acknowledgments: An earlier version of this article appeared as a Liberty Street Economics blog post. The authors thank Steven Block, Kevin Clark, Kevin Duffy, Justin Epstein, Kyra Frye, Pooja Gupta, Helene Hall, Michael Koslow, David Tam, and Tim Wessel for their assistance with the data underlying the charts. They also thank Patrick Dwyer, Angela Sun, Jennifer Wolgemuth, and an anonymous referee for useful comments.

¹ Detailed information about the PDCF is available at: <https://www.newyorkfed.org/markets/primary-dealer-credit-facility>.

² See Adrian, Burke, and McAndrews (2009) for a detailed account of the 2008 PDCF.

³ A list of primary dealers is available at: <https://www.newyorkfed.org/markets/primarydealers>.

⁴ Fleming and Ruela (2020) describe the impact of that volatility in the Treasury market.

⁵ Brickler, Copeland, and Martin (2011) describe the tri-party repo market in simple terms. However, that post is somewhat dated because there is only one remaining clearing bank for tri-party repo in the United States.

⁶ The discount window collateral schedule is available at: https://www.frbdiscountwindow.org/~media/documents/discountmargins_2021.xlsx. The PDCF collateral schedule is available at: <https://www.newyorkfed.org/markets/primary-dealer-credit-facility/primary-dealer-credit-facility-collateral-schedule>.

⁷ Fleming, Sarkar, and Van Tassel (2020) offer an overview of these interventions.

⁸ See Adrian, Burke, and McAndrews (2009) for a detailed account of the 2008 PDCF.

⁹ For example, the 2008 PDCF accepted non-investment-grade forms of discount window-eligible securities after September 14, 2008. See <https://www.federalreserve.gov/newsevents/pressreleases/monetary20080914a.htm>.

¹⁰ Tri-party data starting in May 2010 are available at: <https://www.newyorkfed.org/data-and-statistics/data-visualization/tri-party-repo/index.html#interactive/volume>. Earlier data were made public with the Financial Stability Oversight Council's 2011 annual report available at <https://home.treasury.gov/policy-issues/financial-markets-financial-institutions-and-fiscal-service/financial-stability-oversight-council/studies-and-reports/annual-reports/fsoc-2011-annual-report>.

¹¹ See the the Discount Window FAQ page at <https://www.frbdiscountwindow.org/Pages/General-Information/faq#collapseExample-2-26>.

REFERENCES

- Adrian, T., C. R. Burke, and J. J. McAndrews.* 2009. “The Federal Reserve’s Primary Dealer Credit Facility.” *CURRENT ISSUES IN ECONOMICS AND FINANCE* 15, no. 4. https://www.newyorkfed.org/medialibrary/media/research/current_issues/ci15-4.pdf.
- Adrian, T., and E. Schaumburg.* 2012. “The Fed’s Emergency Liquidity Facilities during the Financial Crisis: The PDCF.” Federal Reserve Bank of New York, *LIBERTY STREET ECONOMICS*, August 22. <https://libertystreeteconomics.newyorkfed.org/2012/08/the-feds-emergency-liquidity-facilities-during-the-financial-crisis-the-pdcf>.
- Brickler L., A. Copeland, and A. Martin.* 2011. “Everything You Wanted to Know about the Tri-Party Repo Market, but Didn’t Know to Ask.” Federal Reserve Bank of New York, *LIBERTY STREET ECONOMICS*, April 11. <https://libertystreeteconomics.newyorkfed.org/2011/04/everything-you-wanted-to-know-about-the-tri-party-repo-market-but-didnt-know-to-ask.html>.
- Carlson, M., and M. Macchiavelli.* 2021. “Primary Markets for Short-Term Debt and the Stabilizing Effects of the PDCF.” Board of Governors of the Federal Reserve System *FEDS NOTES*, Washington, D.C., June 21. <https://doi.org/10.17016/2380-7172.2917>.
- Fleming, M., and F. Ruela.* 2020. “Treasury Market Liquidity during the COVID-19 Crisis.” Federal Reserve Bank of New York, *LIBERTY STREET ECONOMICS*, April 1. <https://libertystreeteconomics.newyorkfed.org/2020/04/treasury-market-liquidity-during-the-covid-19-crisis.html>.
- Fleming, M., A. Sarkar, and P. Van Tassel.* 2020. “The COVID-19 Pandemic and the Fed’s Response.” Federal Reserve Bank of New York. *LIBERTY STREET ECONOMICS*, April 15. <https://libertystreeteconomics.newyorkfed.org/2020/04/the-covid-19-pandemic-and-the-feds-response.html>.
- O’Hara, M., and X. Zhou.* 2021. “Anatomy of a Liquidity Crisis: Corporate Bonds in the COVID-19 Crisis.” *JOURNAL OF FINANCIAL ECONOMICS* 142, no. 1: 46-68.
- Yang, K.* 2020. “The Primary Dealer Credit Facility (PDCF) (U.S. GFC).” *JOURNAL OF FINANCIAL CRISES* 2, no. 3: 152-72.

THE MONEY MARKET MUTUAL FUND LIQUIDITY FACILITY

Kenechukwu Anadu, Marco Cipriani, Ryan Craver, and Gabriele La Spada

OVERVIEW

- On March 20, amid the onset of the COVID-19 pandemic, the Federal Reserve, with prior approval from the U.S. Treasury Secretary, established the Money Market Mutual Fund Liquidity Facility (MMLF). Under the facility, the Federal Reserve Bank of Boston made loans to eligible banks, secured by high-quality assets purchased from eligible MMFs.
- The goals of the MMLF were to help MMFs meet heightened redemptions and runs, to stabilize U.S. short-term funding markets, and to support the provision of credit to the real economy. In total, the facility extended about \$58 billion in credit.
- The authors first discuss the run on MMFs and then describe the MMLF's design, operations, and usage. Then, they identify the facility's effect on investor flows and market prices. Their analysis shows that the MMLF was an important tool in reducing runs on prime MMFs and stabilizing the U.S. short-term funding markets at large.

In March 2020, at the onset of the COVID-19 pandemic, investors redeemed their shares en masse from both domestic and offshore dollar-denominated prime money market funds (MMFs).¹ Relative to the size of the prime MMF industry, the run was remarkably similar to the run that took place in September 2008, during the global financial crisis, notwithstanding the starkly different natures of the shocks that precipitated the two episodes. As was the case in 2008, the 2020 run amplified strains in the short-term funding markets, a key source of liquidity for businesses, as rates on several money market securities increased steeply.

In mid-March, the Federal Reserve, with the approval of the Secretary of the Treasury, established the Money Market Mutual Fund Liquidity Facility (MMLF) to assist MMFs in meeting heightened investor redemptions, stabilize U.S. short-term funding markets, and support the provision of credit to the real economy. Under the facility, which was similar in structure and purpose to the Asset-Backed Commercial Paper Money Market Mutual Fund Liquidity Facility (AMLF) established in 2008, the Board of Governors

Kenechukwu Anadu is a vice president in the Federal Reserve Bank of Boston's Supervision, Regulation, and Credit Department. Marco Cipriani is head of Money and Payments Studies and Gabriele La Spada a financial research economist in the Federal Reserve Bank of New York's Research and Statistics Group. At the time this article was written, Ryan Craver was a senior research analyst in the Research and Statistics Group. Emails: ken.anadu@bos.frb.org, marco.cipriani@ny.frb.org, gabriele.laspada@ny.frb.org.

The views expressed in this article are those of the authors and do not necessarily reflect the position of the Federal Reserve Bank of New York, the Federal Reserve Bank of Boston, or the Federal Reserve System. To view the authors' disclosure statements, visit https://www.newyorkfed.org/research/epr/2022/epr_2022_MMLF_anadu.html.

authorized the Federal Reserve Bank of Boston to make nonrecourse loans to eligible banks to facilitate the purchase of eligible assets from domestic prime MMFs and tax-exempt MMFs.²

In this article, we discuss the March 2020 run on MMFs, describe the design and operations of the MMLF, and assess the facility's effectiveness in stemming fund outflows and calming money market rates. First, we discuss the reasons why investors ran and document the dislocations in money market rates that accompanied the run. As shown in Cipriani and La Spada (2020) and Li et al. (2020), institutional investors ran more from funds for which the imposition of redemption gates and liquidity fees—introduced by the 2014 SEC reform—was more likely due to lower levels of weekly liquid assets (WLA) in their portfolios. The outflows of retail investors, in contrast, were unrelated to fund-level liquidity and reflected other factors, including contagion from the behavior of institutional investors within the same fund family.

Second, we describe the structure of the MMLF and compare it with that of the AMLF, highlighting similarities and differences. Both facilities used banks as a conduit to provide liquidity to domestic prime (and, for the MMLF, also tax-exempt) MMFs. A material difference, however, is that the AMLF facilitated banks' purchases of only asset-backed commercial paper (ABCP) from MMFs, whereas the MMLF made loans against a broader set of assets.

Third, we describe the usage of the MMLF. We show that it was used more by funds that suffered larger outflows, and that funds sold securities with longer maturities, consistent with their incentive to boost their liquidity positions, especially their WLA.³

Finally, we identify the effect of the MMLF on investor flows by showing that, after the facility's introduction, outflows from prime MMFs decreased more for those funds that were eligible to participate in the MMLF program (that is, domestic MMFs), for those that had a larger share of illiquid securities, and for those whose investors were more concerned about the funds' liquidity (that is, institutional MMFs). Moreover, we show that, after the introduction of the MMLF, the rates of MMLF-ineligible securities declined more slowly than those of MMLF-eligible securities, even after controlling for credit risk.

Overall, our analysis shows that, like the AMLF in 2008, the MMLF was an important tool in stabilizing prime MMFs and short-term funding markets at large.

1. BACKGROUND ON MONEY MARKET FUNDS

1.1 Domestic Funds

Domestic MMFs are U.S.-domiciled, open-end mutual funds that invest primarily in U.S. dollar-denominated money market instruments with short maturity and high credit quality. There are two main types of domestic MMFs: (1) government funds, which invest almost all their assets in U.S. government and agency securities and in repurchase agreements (repos) backed by those securities; and (2) prime funds, which can also buy private unsecured debt such as certificates of deposit (CDs), commercial paper (CP), and variable-rate demand notes (VRDNs), in addition to ABCP. At the end of 2019, domestic MMFs had \$4.3 trillion in total net assets, 69 percent held by government funds and 28 percent by prime funds.⁴

Domestic MMFs can also be divided by investor type: retail fund shares can be sold only to “natural persons,” whereas institutional funds are also available to institutions, such as businesses and governments.

Domestic MMFs are regulated by the SEC under Rule 2a-7 of the Investment Company Act of 1940; this rule places limits on the credit risk, liquidity risk, maturity, and concentration of the funds’ portfolios. In response to the 2008 run on prime MMFs, the SEC adopted a set of reforms in 2014 to improve the resilience of prime MMFs and reduce the likelihood of runs.⁵

The 2014 reform changed how prime MMFs sell and redeem shares, thereby directly affecting their runnability. The SEC required that all prime MMFs adopt a system of redemption gates and liquidity fees contingent on the level of weekly liquid assets in their portfolios: if a fund’s WLA falls below 30 percent of its total assets, the fund is allowed (but not required) to impose a liquidity fee of up to 2 percent on all redemptions or to temporarily suspend redemptions for up to ten business days; if a fund’s WLA fall below 10 percent, the fund must impose a fee of 1 percent unless its board determines that doing so is not in the interests of the fund’s shareholders.⁶

Additionally, the SEC required that institutional prime MMFs sell and redeem their shares at a price that reflects the market value of the fund’s underlying securities (floating net asset value, or floating NAV); that is, institutional investors can no longer buy and redeem their shares at a stable NAV (typically \$1 per share) as they had previously done and as retail prime investors can still do. Government MMFs were largely unaffected by the 2014 reform.

1.2 Offshore Funds

Offshore MMFs are European-domiciled, open-end funds that, like domestic MMFs, invest in U.S. dollar-denominated money market instruments and can be divided into government and prime funds based on their portfolio holdings.⁷ Unlike domestic MMFs, however, offshore MMFs are almost exclusively held by institutional investors.⁸

Offshore MMFs are regulated under Regulation (EU) 2017/1131 of the European Parliament and of the Council of the EU, which was also adopted in response to the run experienced by offshore MMFs in 2008. Similarly to the 2014 SEC reform, this new rule introduced a system of redemption gates and liquidity fees contingent on the level of liquidity in the fund’s portfolio for the subset of offshore prime funds that are allowed to transact at a stable NAV (low-volatility NAV funds).⁹

2. THE MARCH 2020 RUN

2.1 Fund Flows

Starting on March 6, 2020, when the COVID-19 pandemic became of increasing concern in the United States and Europe, domestic and offshore prime MMFs began experiencing outflows that quickly accelerated over the next several days.¹⁰ These outflows slowed

CHART 1

Prime-MMF Outflows, January–April 2020

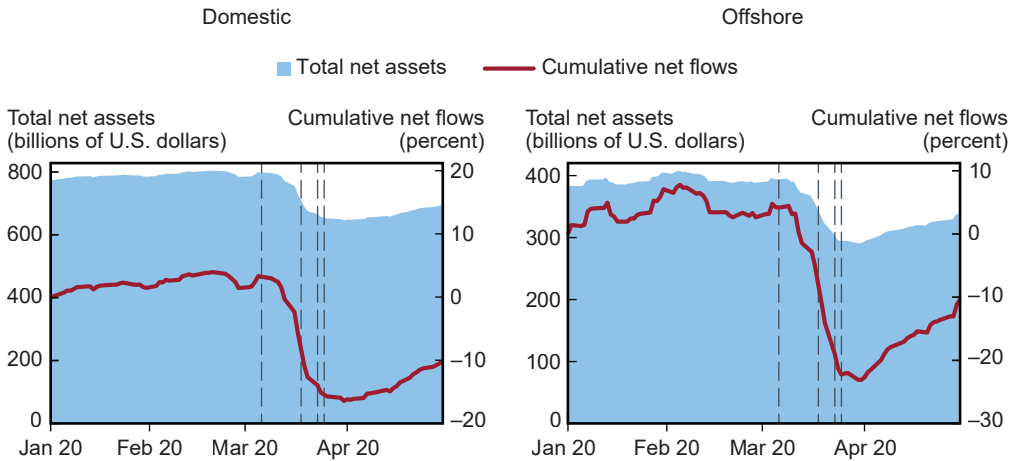

Sources: iMoneyNet; staff calculations.

Notes: The chart shows total net assets in billions of U.S. dollars and cumulative net flow relative to December 2019 in percent for domestic prime funds (left panel) and offshore prime funds (right panel) from January to April 2020. Vertical lines show March 6 (beginning of the 2020 run), March 18 (MMLF announcement), March 23 (MMLF opening), and March 25 (when the MMLF started accepting CDs and VRDNs as collateral).

significantly after the Federal Reserve established the MMLF in mid-March. Between March 6 and March 26, domestic funds lost \$143 billion, or 19 percent of the industry's assets in December 2019 (Chart 1, left panel). These outflows are comparable to those suffered by domestic prime MMFs during the September 2008 run, when their assets dropped by 18 percent relative to August (see Chart 2). The experience for offshore prime MMFs was similar to that of domestic funds: they lost \$100 billion over the March 6–26 period, corresponding to 27 percent of their assets in December 2019 (Chart 1, right panel).

The March 2020 and September 2008 runs share two other important similarities. First, in both cases, outflows from prime MMFs were accompanied by large inflows into government MMFs, which represent a safe haven for investors. The assets of domestic government MMFs increased by \$827 billion (31 percent) in March 2020 and by \$334 billion (36 percent) in September 2008. Similar inflows were observed into offshore government funds, both in March 2020 (70 percent) and in September 2008 (65 percent).

Second, during both runs, institutional prime funds experienced larger outflows than retail prime funds. Between March 6 and March 26, 2020, outflows from domestic institutional funds had reached 33 percent of their assets in December 2019; outflows from domestic retail funds were only 10 percent of their December 2019 assets. In other words, institutional investors seem to be quicker to move their money in times of uncertainty.

CHART 2

Prime-MMF Outflows, July-October 2008

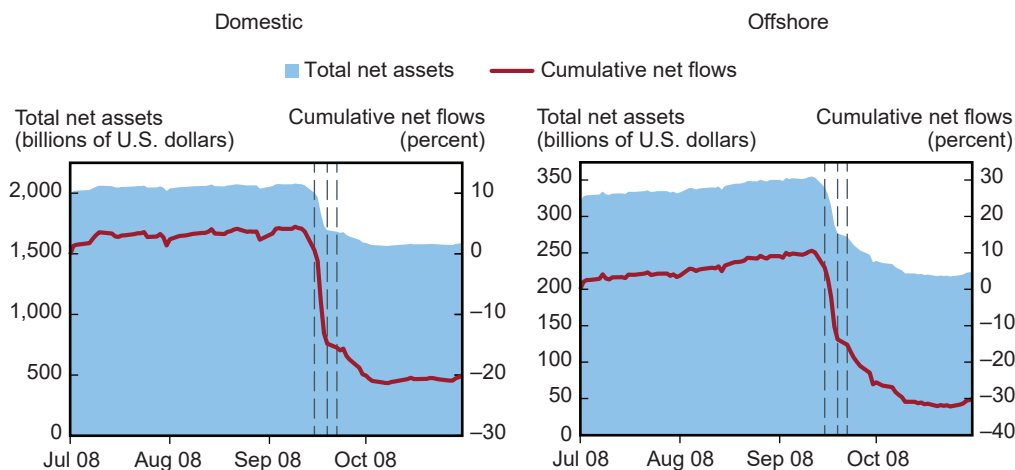

Sources: iMoneyNet; staff calculations.

Notes: The chart shows total net assets in billions of U.S. dollars and cumulative net flow relative to June 2008 in percent for domestic prime funds (left panel) and offshore prime funds (right panel) from July to October 2008. Vertical lines show September 15 (beginning of the 2008 run), September 19 (AMLF announcement), and September 22 (AMLF opening).

2.2 Money Market Rates

Large outflows from prime MMFs were accompanied by price dislocations in money market rates. Between March 6 and March 18, before the announcement of the MMLF, the spreads between several secondary market rates and the interest rate on excess reserves (IOER) rose markedly (Chart 3, left panel). The spreads for overnight AA-rated ABCP and AA-rated nonfinancial CP increased by 1.1 and 1.0 percentage points, respectively. The effect on second-tier nonfinancial CP was even stronger, with the spread reaching 3.2 percentage points on March 17. Not all money market rates increased by the same amount: for instance, the increase in the spread of overnight AA-rated financial CP was a modest 0.05 percentage point.

These price dislocations were very large by historical standards and comparable to those observed during the 2008 crisis. On September 16, 2008, the day the Reserve Primary Fund “broke the buck,” the spreads between the rates of overnight AA-rated ABCP and second-tier nonfinancial CP and the target effective federal funds rate surged to 3.6 and 3.8 percentage points.¹¹ Similar, although smaller, rate spikes also occurred for AA financial and nonfinancial CP.

Rates on CDs also increased sharply in March 2020 to then retrace their paths after the MMLF was introduced. As the right panel of Chart 3 shows, rates on both negotiable CDs and nonnegotiable deposits with remaining maturity within seven days spiked in the week ahead of the MMLF introduction, when MMFs suffered the largest outflows.

CHART 3

Dislocation in Money Market Rates in 2020: Spreads Relative to IOER

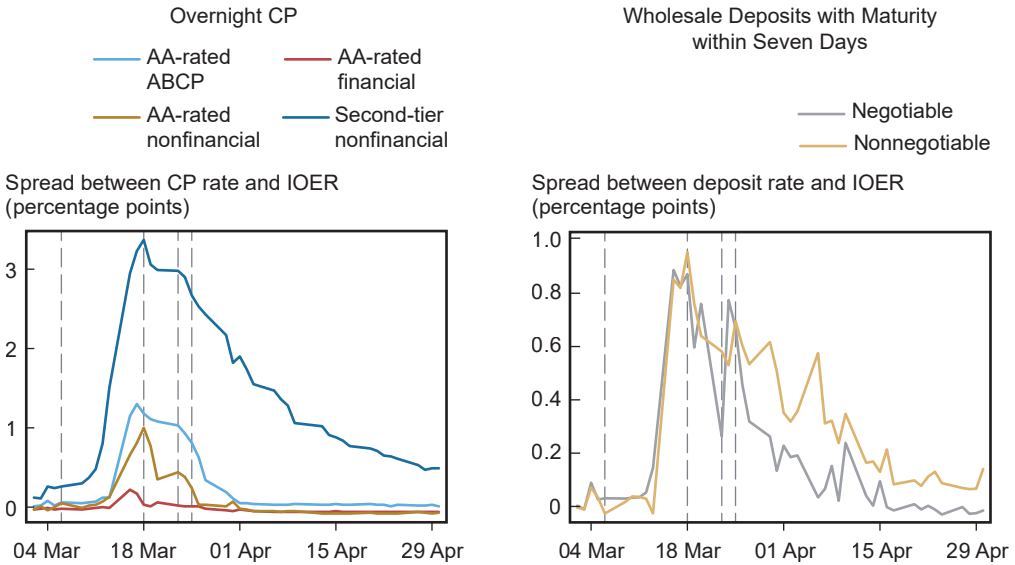

Sources: Federal Reserve Board of Governors; Federal Reserve Bank of St. Louis, FRED database; FR2420, *Report of Selected Money Market Rates*; staff calculations.

Notes: The left panel shows the daily average spread between several overnight CP rates (AA ABCP, AA financial CP, AA nonfinancial CP, and second-tier nonfinancial CP) and the IOER in percentage points from March to April 2020. The right panel shows the daily average spread relative to IOER for negotiable CDs and nonnegotiable deposits (CDs and TDs) with maturity within seven days. Vertical lines show March 6 (beginning of the 2020 run), March 18 (MMLF announcement), March 23 (MMLF opening), and March 25 (when the MMLF started accepting CDs and VRDNs as collateral).

2.3 The Role of WLA

Several recent papers have suggested that one of the reasons investors ran from prime MMFs in March 2020 was the fear that redemption gates and liquidity fees would be imposed under the terms of the 2014 SEC reform.¹² Cipriani and La Spada (2020) and Li et al. (2020) find that institutional funds with lower weekly liquid assets—and therefore, for which the imposition of gates and fees was more likely—experienced significantly larger outflows. For domestic institutional funds, Cipriani and La Spada (2020) find that a 10 percentage point decrease in a fund’s WLA at the end of 2019 (that is, before the run started) increases daily outflows during the COVID-19 run by 1.1 percentage points. Results from Li et al. (2020) are similar.

Investor concerns around the imposition of gates or fees were not the only cause behind the large outflows observed in March 2020. MMFs are vulnerable to runs because they perform liquidity transformation and cater to investors with low risk tolerance. Among offshore MMFs, Cipriani and La Spada (2020) show that contagion within fund families also played a role: outflows from offshore prime MMFs were larger for those funds in families

also offering domestic institutional prime funds; in other words, there was a cross-border spillover from U.S. to European prime MMFs within the same family. Outflows from other types of mutual funds without fees and gates, such as ultrashort bond funds, were also very large in March.

Importantly, outflows from retail prime MMFs were not affected by funds' WLA (and the likelihood of gates and fees) but likely reflected other vulnerabilities. For instance, Cipriani and La Spada (2020) show that retail funds suffered larger outflows if they belonged to families also offering domestic institutional prime funds. This evidence of within-family contagion is consistent with less sophisticated retail investors using the actions of more sophisticated institutional investors in their own fund family as a signal.

3. THE MONEY MARKET MUTUAL FUND LIQUIDITY FACILITY (MMLF)

3.1 The Facility

On March 18, 2020, the Federal Reserve—with the approval of the Secretary of the Treasury and \$10 billion in credit protection from the Exchange Stabilization Fund—announced the introduction of the MMLF to provide liquidity to MMFs.¹³ In designing the facility, the Federal Reserve had to address two challenges. One challenge is the need to protect itself from credit risk, for example by offering loans only against high-quality collateral. Another challenge is fact that lending to MMFs would increase their leverage, thereby amplifying any losses for shareholders and increasing their incentive to run.

The Federal Reserve had faced the same challenges in 2008, when it set up the AMLF in response to the MMF run triggered by Lehman Brothers' default. Although the type of shock was different, it was natural to design the 2020 facility based on its 2008 predecessor.

Through the MMLF, which was established under the authority of Section 13(3) of the Federal Reserve Act, the Federal Reserve Bank of Boston made nonrecourse loans to eligible borrowers, taking as collateral eligible assets purchased by the borrowers from eligible MMFs. The eligible borrowers were U.S. depository institutions, U.S. bank holding companies (parent companies incorporated in the United States or their U.S. broker-dealer subsidiaries), and U.S. branches and agencies of foreign banks. Eligible collateral was limited to U.S. Treasury securities and fully guaranteed agency securities, government-sponsored enterprise (GSE) securities, highly rated CP (including ABCP), negotiable CDs, and short-term municipal debt (including VRDNs that met certain criteria).¹⁴ Eligible MMFs were limited to domestic prime and tax-exempt MMFs. Table 1 presents a timeline for the evolution of the MMLF.

The MMLF lending rate was equal to the primary credit rate (PCR) offered by the Federal Reserve Bank of Boston at the time the loan was made plus a spread based on the collateral type. Specifically, the rate for loans secured by U.S. Treasury securities, fully guaranteed agencies, and GSE debt was equal to the PCR. Loans secured by municipal short-term debt, including VRDNs, were made at the PCR plus 25 basis points. The rates on all other MMLF loans were equal to the primary credit rate plus 100 basis points.¹⁵ The maturity of each MMLF

TABLE 1
Evolution of the MMLF

Date	Eligible Funds	Eligible Collateral
March 18 (facility is announced)	Domestic prime MMFs	U.S. Treasuries and fully guaranteed agencies; securities issued by GSEs; certain ABCP; certain CP
March 20 (eligible funds and eligible collateral are expanded)	Domestic prime and tax-exempt MMFs	U.S. Treasuries and fully guaranteed agencies; securities issued by U.S. GSEs; certain ABCP; certain CP; certain U.S. municipal short-term debt
March 23 (facility opens; further expansion of eligible collateral is announced)	Domestic prime and tax-exempt MMFs	U.S. Treasuries and fully guaranteed agencies; securities issued by U.S. GSEs; certain ABCP; certain CP; certain U.S. municipal short-term debt; certain CDs; certain VRDNs

loan was equal to the remaining maturity of the collateral pledged under the facility, up to a maximum of twelve months. There was no haircut on the collateral.

Importantly, the Federal Reserve, the Office of the Comptroller of the Currency, and the Federal Deposit Insurance Corporation allowed banks to neutralize the effects of participating in the MMLF on their risk-based and leverage capital ratios by excluding the effects of buying assets through the MMLF from the calculation of regulatory capital requirements.¹⁶ Moreover, on May 5, the same agencies collectively issued an interim final rule that neutralized the impact of the nonrecourse funding provided by the MMLF on the calculation of banks' liquidity coverage ratios.

3.2 Comparison with the AMLF

The core structure and design of the MMLF was based on the Asset-Backed Commercial Paper Money Market Mutual Fund Liquidity Facility (AMLF), which was established in response to the September 2008 run on MMFs. Accordingly, the AMLF and MMLF were very similar, both in terms of institutional set-up and intentions. First, as with the MMLF, the AMLF was created by the Federal Reserve under the authority of Section 13(3) of the Federal Reserve Act.¹⁷ Second, the AMLF was administered by the Federal Reserve Bank of Boston, which made nonrecourse loans to eligible borrowers, taking as collateral eligible assets purchased by the borrowers from prime MMFs. Finally, each AMLF loan was also fully collateralized by the security purchased by the AMLF borrower: the collateral was purchased at amortized cost and had to be top-rated, with the maturity of the loan matching the remaining maturity of the collateral.¹⁸

There are, however, some important differences. First, as its name implies, eligible collateral under the AMLF was limited to certain ABCP, as the ABCP market was much larger in 2008 and had been under particularly severe stress during the global financial crisis. In contrast, the MMLF accepted a broader slate of collateral, as previously discussed. Second, given the improvements in financial conditions that followed the establishment of the AMLF, the Federal Reserve amended the AMLF in June 2009 to require that, in order to be eligible to participate,

CHART 4

MMLF Pledges by Asset Category

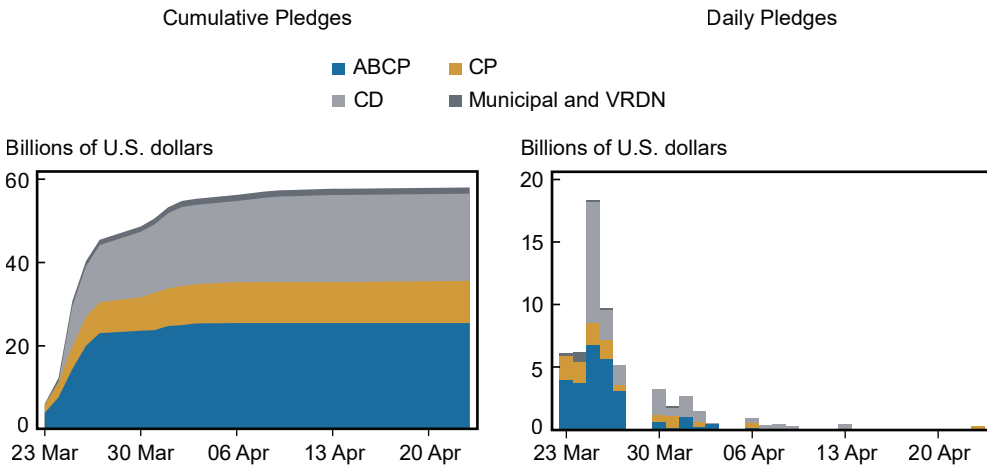

Sources: Federal Reserve Bank of Boston; staff calculations.

Notes: The left panel shows the cumulative value of the assets pledged to the MMLF in billions of U.S. dollars, by asset category; the right panel shows their daily value in billions of U.S. dollars.

MMFs must have experienced single-day or multiple-day net redemptions that exceeded set thresholds;¹⁹ there was no such requirement under the MMLF.

The AMLF was announced on September 19, 2008, began operations on September 22, and was closed on February 1, 2010.

3.3 MMLF Usage

From its opening (March 23, 2020) to its last transaction (April 23, 2020), the MMLF extended loans to nine banks and bank holding companies, which purchased \$58 billion of securities from MMFs (Chart 4, left panel).²⁰ For comparison, the value of the ABCP pledged to the AMLF in 2008 was much larger, at about \$200 billion, but its usage relative to the industry's assets was only slightly higher than the MMLF's.²¹ As had happened with the AMLF, all loans made under the MMLF were repaid in full, with interest, in accordance with the terms of the facility.

Of the securities pledged to the MMLF, 44 percent were ABCP, 36 percent CDs, 18 percent unsecured CP, and the rest VRDNs and municipal debt, consistent with funds using the MMLF mainly to sell their illiquid assets to meet redemptions and stem future ones. Daily sales were the highest (\$18 billion) on March 25 (Chart 4, right panel), two days after it was announced that negotiable CDs and VRDNs were MMLF-eligible; 53 percent of the March 25 sales were indeed CDs.²²

The facility was used by 47 domestic prime MMFs out of a total of 95. Table 2 shows average portfolio characteristics of domestic prime MMFs at the end of February 2020, separating funds that participated in the MMLF from those that did not.²³ Sixty-three percent

TABLE 2
Characteristics of Domestic Prime MMFs as of February 2020 for MMLF Participants and Nonparticipants

	Participated	Did Not Participate	Difference
TNA (billions of dollars)	10.3 (21.1)	18.0 (36.3)	-7.7 (-1.0)
WAM (days)	31.7 (8.8)	28.3 (6.6)	3.3 (1.4)
WLA (percent)	41.7 (5.2)	43.6 (7.4)	-2.0 (-1.2)
ABCP (percent)	12.5 (9.7)	6.8 (10.9)	5.6* (2.0)
CD (percent)	25.9 (13.8)	21.4 (14.8)	4.5 (1.1)
CP (percent)	35.4 (14.2)	43.9 (23.2)	-8.5* (1.8)
Treasury (percent)	1.3 (2.3)	3.5 (7.3)	-2.2* (-1.8)
Agency (percent)	1.4 (3.9)	3.5 (7.3)	-2.1 (-1.5)
Repos (percent)	21.1 (10.3)	15.3 (11.3)	5.8* (2.0)
Flows (percent)	-19.1 (19.3)	2.6 (12.6)	-21.7*** (-4.4)
Institutional (percent)	62.8	22.2	40.6*** (3.1)

Sources: Federal Reserve Bank of Boston; iMoneyNet; Securities and Exchange Commission; staff calculations.

Notes: The first two columns show the mean and standard deviation (in parentheses) of funds' characteristics at the end of February 2020. The third column presents the difference in the means and the *t*-statistic for the null that the means are equal. TNA is the fund's total net assets. WAM is the weighted average maturity of the fund's portfolio. WLA is the percentage of weekly liquid assets in the fund's portfolio. ABCP, CD, CP, Treasury, agency, and repos are the percentage of the fund's portfolio invested in those asset types. Flows is the net flow between March 6 and March 20 (that is, from the start of the run until the last business day before the MMLF opened) relative to the fund's TNA at the end of February. Institutional is the percentage of MMFs that were institutional funds.

* $p < 0.10$

** $p < 0.05$

*** $p < 0.01$

CHART 5

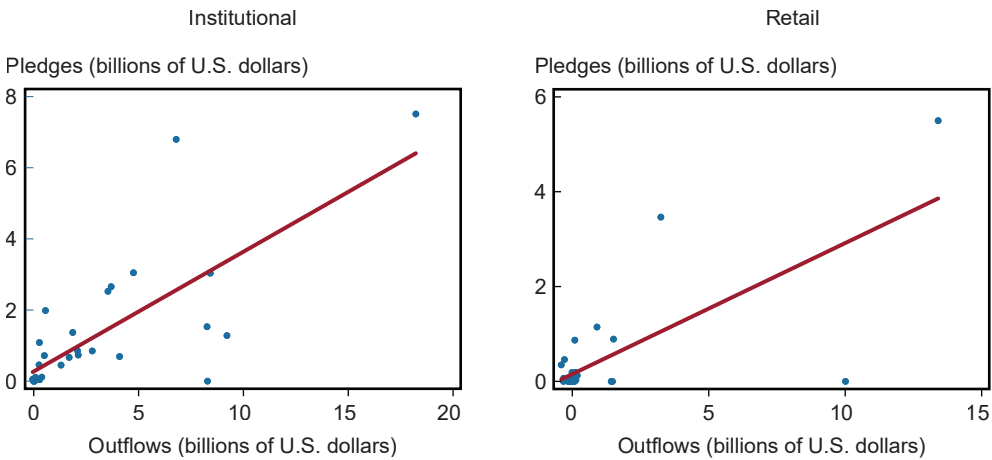
Fund-Level MMLF Pledges vs MMF Outflows during the March 2020 Run
(March 6-20)

Sources: Federal Reserve Bank of Boston; iMoneyNet; staff calculations.

Notes: The chart plots fund-level pledges to the MMLF against fund-level outflows in billions of U.S. dollars from March 6, the start of the run, through March 20, the last business day before the opening of the MMLF. Institutional funds are shown in the left panel; retail funds are shown in the right panel.

of participating funds were institutional funds. Funds that participated in the MMLF held more ABCP and repos and less Treasury securities and unsecured CP than funds that did not. The most important differences, however, are that funds that participated in the MMLF experienced significantly larger outflows during the run (a 22 percentage point difference from March 6 to March 20) and were more likely to be institutional funds.²⁴

Funds that experienced larger outflows during the run and before the opening of the MMLF (March 6-20) were more likely to use the MMLF and pledged more assets to it (Chart 5). For both institutional and retail funds, there is a positive relationship between the outflows suffered during the run and the fund's usage of the MMLF. We estimate the magnitude of this relationship through regression analysis: a \$1 billion dollar increase in outflows during the run (March 6-20) leads to an increase in MMLF asset pledges of \$337 million for institutional funds and \$275 million for retail funds; these effects are not only statistically significant but also economically important (see Box 1).

Through the MMLF, domestic prime funds boosted their liquidity positions by selling their more illiquid assets.²⁵ The WLA of institutional funds dropped in the week ahead of the introduction of the MMLF, when outflows were the highest and MMFs struggled to meet investors' redemptions with their liquid assets. Their WLA, however, bounced back after the MMLF began its operations and, starting from early April, institutional funds' WLA exceeded their February 2020 levels (Chart 6, left panel).²⁶ Although the WLA of retail funds did not drop materially during the run, likely because they suffered smaller redemption pressure, these funds also significantly increased their WLA positions after the introduction of the MMLF (Chart 6, right panel).²⁷

Box 1

MMLF Usage as a Function of Funds' Outflows

We run the following fund-level cross-sectional regression:

$$MMLF\ Pledges_i = \alpha + \beta_0 Inst_i + \beta_1 Run\ Flows_i + \beta_2 Inst_i * Run\ Flows_i + \epsilon_i,$$

where *MMLF Pledges_i* is the pledge of fund *i*'s assets to the MMLF in billions of dollars; *Inst_i* is a dummy variable for institutional funds; and *Run Flows_i* is fund *i*'s cumulative net flows for the run period in billions of dollars. The regression is run on prime-MMF data from iMoneyNet. The model is estimated for three run periods: March 6-18, March 6-20, and March 6-26 (see table, columns 1-3). *t* statistics, in parentheses, are robust to heteroskedasticity.

	MMLF Pledges (Billions of Dollars)		
	(1)	(2)	(3)
Inst	0.057 (0.35)	0.107 (0.66)	0.047 (0.28)
Run Flows (billions of dollars)	-0.410* (-1.98)	-0.275** (-2.11)	-0.188** (-2.08)
Inst*Run Flows (billions of dollars)	-0.055 (-0.25)	-0.062 (-0.42)	-0.140 (-1.28)
Observations	61	61	61
Run period	3/6-3/18	3/6-3/20	3/6-3/26

Sources: Federal Reserve Bank of Boston; iMoneyNet; staff calculations.

Note: Values in parentheses are *t* statistics.

* *p* < 0.10

** *p* < 0.05

CHART 6

Weekly Liquid Assets (WLA) of Prime MMFs, January-April 2020

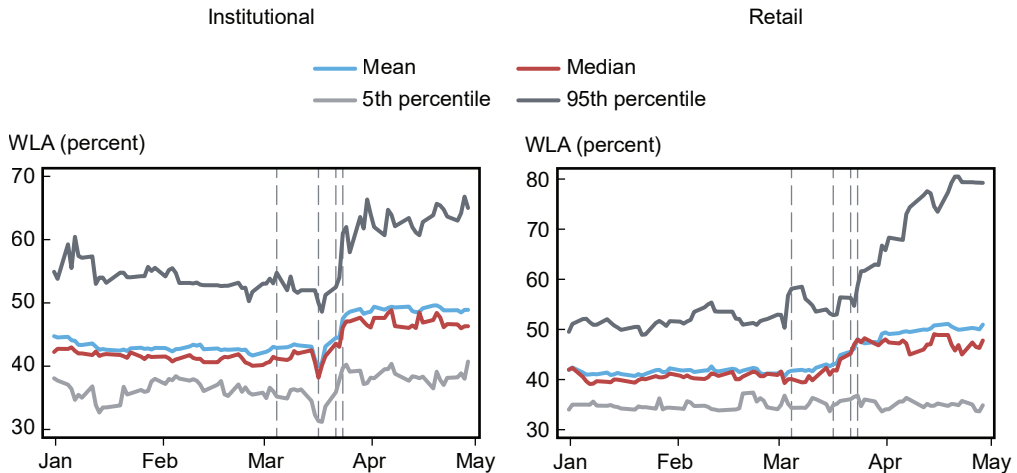

Sources: iMoneyNet; staff calculations.

Notes: The chart shows the average and median shares of WLA, together with the 5th and 95th percentiles, in the portfolios of institutional (left panel) and retail (right panel) prime MMFs from January to April 2020. Data are in percent and at the daily frequency. Vertical lines show March 6 (beginning of the 2020 run), March 18 (MMLF announcement), March 23 (MMLF opening), and March 25 (when the MMLF started accepting CDs and VRDNs as collateral).

Table 3 shows the average remaining maturities, computed as of the end of February 2020, of the ABCP, CP, and CDs pledged to the MMLF and compares them with the average remaining maturities of the same security types held by prime MMFs at the end of February.²⁸ For all asset classes, the average maturity of the securities pledged is significantly greater than the average maturity of the securities held: the difference ranges from 16 (CDs) to 34 (CP) days. Li et al. (2020) obtains similar results in a regression setting. This evidence shows that prime funds boosted their liquidity by selling assets with longer maturities, which were more likely to be illiquid.²⁹

3.4 Effect of the MMLF on Investor Flows

Outflows from prime MMFs began to abate shortly after the MMLF was announced on March 18. Between March 23 (the first day of MMLF operations) and the end of March, domestic prime MMFs suffered outflows of only \$28 billion, more than half of which occurred over the first two days of MMLF operation, that is, before CDs and VRDNs could be pledged at the MMLF. At the beginning of April, domestic prime MMFs started to experience moderate inflows, and by the end of April, they received net inflows of \$47 billion (33 percent of what they lost during the run). The rebound for offshore prime MMFs was similar: they suffered outflows until April 1, when their assets reached their minimum level for 2020, but from April 1 onward, they experienced net inflows for twelve consecutive days, for a total of \$28 billion (28 percent of what they lost during the run).

One could wonder whether such a massive reduction in outflows was due to the MMLF or rather to changing market conditions. The task of identifying the impact of the MMLF is made

TABLE 3
Average Remaining Maturity of Securities Sold to the MMLF and of Those in the Portfolio of Prime MMFs at the End of February 2020

	ABCP			CP			CD		
	Held at end of February	Sold to MMLF	Difference	Held at end of February	Sold to MMLF	Difference	Held at end of February	Sold to MMLF	Difference
Remaining maturity at end-February (days)	74 (65)	93 (46)	19.3*** (6.8)	100 (87)	134 (76)	33.8*** (5.7)	117 (90)	133 (96)	15.6*** (2.9)

Sources: Federal Reserve Bank of Boston; iMoneyNet; Securities and Exchange Commission; staff calculations.

Notes: The table shows the mean and standard deviation (in parentheses) of the remaining maturities of the ABCP, CP, and CDs held in MMF portfolios at the end of February 2020 and of the ABCP, CP, and CDs pledged by MMFs to the MMLF. The third column for each security type shows the difference between the means and the *t*-statistics for the null that the means are equal. Remaining maturities are calculated in days relative to February 28.

more difficult by the fact that other Federal Reserve facilities, such as the Commercial Paper Funding Facility and the Primary Dealer Credit Facility, were established at the same time.³⁰

To identify the effect of the MMLF on fund flows and measure its effectiveness in stemming the run, we follow a methodology similar to that developed by Duygan-Bump et al. (2013) to estimate the impact of the AMLF. The authors proposed to identify the impact of the AMLF on outflows by assuming that it should be stronger for funds that have relatively more ABCP to sell to the AMLF.³¹

Similarly, through regression analysis, we estimate the impact of the MMLF by assuming that it should be stronger on those funds that hold relatively more illiquid assets in their portfolios (which therefore benefit more from the MMLF's liquidity provision) and whose investors are more concerned about the funds' liquidity (see Box 2). For domestic institutional prime MMFs, a 10 percentage point increase in the share of illiquid securities in the fund's portfolio leads to an increase in daily flows of 0.4 percentage point after the introduction of the MMLF. This effect is not only statistically significant but also economically important: over the twenty business days (that is, roughly a month) following the opening of the facility, it amounts to an increase in cumulative flows of 8 percentage points.

For retail funds, in contrast, the share of illiquid securities in the fund portfolio does not have a material effect on the fund's post-MMLF flows, a result consistent with the fact that retail outflows during the run were unrelated to funds' liquidity positions; as discussed above, retail fund outflows were driven by other factors, including, in particular, a contagion spillover from the outflows in the institutional prime funds in the same family (Cipriani and La Spada 2020). The results are also insignificant for offshore prime MMFs, which is consistent with the fact that offshore funds were not eligible to participate in the MMLF. This evidence, however, should not be read as implying that the MMLF did not have an impact on retail or offshore funds; indeed, as mentioned above, outflows from those funds also abated after the inception of the facility. Arguably, the reduction in retail and offshore outflows was not a direct result of the funds' use of the facility; rather, it was likely due to the overall improvement in secondary market conditions and the reduction in contagion spillovers from institutional funds.

3.5 Effect of the MMLF on Secondary-Market Rates

Money market rates declined after the introduction of the MMLF (Chart 3). The spreads between rates for top-rated CP (both secured and unsecured) and the IOER went back to their pre-crisis levels by April 1, that is, roughly within a week after the MMLF began operations. The reduction in second-tier nonfinancial CP was also visible but more gradual: at the end of April 2020, its spread relative to the IOER was still around 0.5 percent, up from 0.1 percent at the end of February.

As with flows, it is difficult to attribute the improvement in market rates to the MMLF because market conditions were changing dramatically over the run period. To identify the effect of the MMLF on money market rates, we exploit the fact that second-tier CP is not eligible collateral under the MMLF. Therefore, we expect that, if the MMLF had an impact, rates on second-tier CP should revert more slowly than other CP rates across maturity buckets. Regression analysis shows that, in the month following the introduction of the MMLF, the rates of second-tier CP declined less than those of top-rated ones by 0.9 percentage point; this result holds across all maturity buckets considered, from overnight to thirty days (see Box 3).

Box 2

Effect of the MMLF on the Flows in Prime MMFs

We run the following fund-level panel regression at a daily frequency on January-April 2020:

$$Flows_{it} = \alpha_i + \mu_t + \beta MMLF_t \times IlliquidSecurities_i + \epsilon_{it},$$

where $Flows_{it}$ is the net flow in fund i on day t as a percentage of its total net assets (TNA) on the previous business day; $MMLF_t$ is a dummy equal to one after the MMLF became operational (March 23); and $IlliquidSecurities_i$ is the share of illiquid securities in the portfolio of fund i . $IlliquidSecurities_i$ includes ABCP, unsecured CP, CDs, and VRDNs; we measure the share of illiquid securities in a fund's portfolio in December 2019 to mitigate endogeneity issues. We include fund fixed effects (α_i) to control for unobservable fund-specific characteristics, and time fixed effects (μ_t) to control for unobservable macro factors. Standard errors are robust to heteroskedasticity and to both a serial and cross correlation (Driscoll-Kraay standard errors with ten lags). The regression is run on prime-MMF data from iMoneyNet.

The model is estimated separately on domestic institutional, domestic retail, and offshore prime funds (see table, columns 1-3).

	Flows (Percent)		
	(1)	(2)	(3)
MMLF * Illiquid Securities (percent)	0.043*** (2.72)	-0.006 (-1.17)	-0.001 (-0.17)
Observations	2,573	2,560	2,295
Sample	Institutional	Retail	Offshore
Date fixed effects	Yes	Yes	Yes
Fund fixed effects	Yes	Yes	Yes

Sources: iMoneyNet; staff calculations.

Note: Values in parentheses are t statistics.

*** $p < 0.01$

For robustness, we also estimated the regression changing the definition of the MMLF dummy to when the facility was announced (March 18) and to when it started accepting CDs and VRDNs (March 25); results (not shown) are largely similar.

Box 3

Effect of the MMLF on CP Rates

We run the following regression on a panel of daily rates for various CP types and maturity buckets:

$$Rate_{it} = \alpha_i + \mu_t + \beta MMLF_t \times SecondTier_i + \epsilon_{it},$$

where $Rate_{it}$ is the spread between the rate of CP of type i and the IOER on day $MMLF_t$ is defined as in Box 2; and $SecondTier_i$ is a dummy for second-tier CP, which were not eligible for the MMLF. The types of CP included are AA ABCP, AA financial unsecured CP, AA nonfinancial unsecured CP, and second-tier nonfinancial CP. We include security-type fixed effects (α_i) to control for unobservable security-type characteristics, and time fixed effects (μ_t) to control for macro factors. Data on CP rates are from the Federal Reserve Board. The model is estimated on January–April 2020, and standard errors are Driscoll-Kraay with ten lags.

The model is estimated separately on overnight, seven-day, and thirty-day maturities (see table, columns 1-3).

Since the slower normalization of second-tier CP rates after the introduction of the MMLF could be at least partially driven by their higher credit risk—rather than their ineligibility under the MMLF—for robustness, we estimate the regression also including as regressor the interaction of the VIX index, which captures changes in market volatility, with the dummy for second-tier CP; although the results are smaller in magnitude, they are qualitatively similar (see table, columns 4-6).

	Rate (Percent)					
	(1)	(2)	(3)	(4)	(5)	(6)
MMLF*Second Tier	0.894*** (2.71)	0.873*** (3.55)	0.952*** (6.42)	0.315 (1.26)	0.417** (2.29)	0.587*** (4.13)
VIX*Second Tier				0.031*** (4.53)	0.024*** (4.74)	0.019*** (4.69)
Observations	332	314	289	332	314	289
Maturity	Overnight	7 day	30 day	Overnight	7 day	30 day
Security-type fixed effects	Yes	Yes	Yes	Yes	Yes	Yes
Date fixed effects	Yes	Yes	Yes	Yes	Yes	Yes

Sources: Federal Reserve Bank of St. Louis, FRED database; Federal Reserve Board (CP rates); staff calculations.

Note: Values in parentheses are t statistics.

** $p < 0.05$

*** $p < 0.01$

Box 4

Effect of the MMLF on CD Rates

The table below reports the estimates of the regressions described in Box 3 run on CD rates (instead of CP rates, which could also be affected by the CPFF); data are from Form FR2420. To identify the impact of the MMLF on CD rates, we interact the MMLF dummy with a dummy for nonnegotiable CDs, which, like second-tier CP, were not eligible for the MMLF. We estimate the model separately for deposits with remaining maturities within seven days and fifteen to thirty days (see table, columns 1 and 2). Standard errors are Driscoll-Kraay with ten lags. The sample period is January–April 2020.

As with CP, we also estimate the regression on CD rates including as regressor the interaction of the VIX with the dummy for nonnegotiable deposits, to control for the effect of a possible difference in credit risk. The results (see table, columns 3 and 4) are similar to the baseline results.

	Rate (Percent)			
	(1)	(2)	(3)	(4)
MMLF*Nonnegotiable	0.176*** (5.97)	0.098*** (3.28)	0.171*** (5.55)	0.127*** (3.03)
VIX*Nonnegotiable			0.000 (1.02)	-0.001 (-1.15)
Observations	164	160	162	158
Maturity	Within 7 days	15-30 days	Within 7 days	15-30 days
Security-type fixed effects	Yes	Yes	Yes	Yes
Date fixed effects	Yes	Yes	Yes	Yes

Sources: FR2420, *Report of Selected Money Market Rates*; staff calculations.

Note: Values in parentheses are *t* statistics.

*** $p < 0.01$

Roughly at the same time as the MMLF, the Federal Reserve also established the Commercial Paper Funding Facility (CPFF) to provide liquidity to CP issuers. The CPFF supported only primary issuance, not the secondary market; nevertheless, since the CPFF also did not accept second-tier CP, the above results could be driven by the impact of the Federal Reserve's support of CP issuance on secondary markets. To address this concern, we repeat a similar regression analysis for CDs, whose issuance was not supported by the CPFF. To identify the effect of the MMLF on CD rates, we exploit the fact that only negotiable CDs could be pledged to the facility. Results are similar to those for CP: after the introduction of the MMLF, the rates of nonnegotiable deposits maturing within seven days decline by 0.2 percentage point less than those of negotiable CDs with the same maturity. The result is weaker for CDs with maturities of fifteen to thirty days but still statistically significant (see Box 4).

4. CONCLUSION

In March 2020, as the COVID-19 pandemic was hitting the United States and Europe, prime MMFs suffered very large investor outflows, similar in percentage terms to those experienced in 2008 during the global financial crisis. The Federal Reserve established the MMLF to assist “money market funds in meeting demands for redemptions by households and other investors, enhancing overall market functioning and credit provision to the broader economy.”³²

Through the MMLF, the Federal Reserve Bank of Boston made nonrecourse loans to eligible borrowers, taking as collateral eligible assets purchased by the borrowers from eligible MMFs. The facility, which was similar to the AMLF established in 2008, absorbed \$58 billion of prime and tax-exempt MMF assets. With the facility’s assistance, MMFs sold their most illiquid securities, thereby boosting their liquidity positions while meeting redemptions. In the aftermath of the MMLF’s inception, outflows from prime funds abated, and the strains in the broader short-term funding markets subsided.

Because the MMLF was established in the midst of a financial crisis and a rapidly changing economic outlook, it is difficult to directly estimate its impact. Nonetheless, we provide evidence that the facility directly helped stem outflows from prime MMFs and contributed to the easing in money market rates. Because of its positive effect on secondary markets, the facility also had a beneficial impact on offshore prime MMFs, which it did not directly target. By helping prime MMFs meet redemptions and reduce their outflows, the facility improved overall market functioning and supported credit provision to the real economy.

NOTES

Acknowledgments: The authors thank Catherine Huang, Abduel Hussein, and Reed Orchinik for excellent research assistance. They also thank Jie Chen, Christine Docherty, Lei Li, Marco Macchiavelli, Patrick McCabe, and an anonymous referee for useful comments.

¹ Domestic MMFs are registered with the Securities and Exchange Commission (SEC) and are governed by its Rule 2a-7. Offshore MMFs are dollar-denominated, domiciled in the member states of the European Union (EU), and governed by EU rules.

² Tax-exempt MMFs mainly invest in debt issued by state and local governments. They represent a very small fraction of the industry and are not the focus of this article. All of our analyses, with the exception of the statistics on MMLF usage, focus on prime funds only.

³ As explained above and in Section 3.1, through the MMLF, the Federal Reserve Bank of Boston made loans available to eligible banks secured by assets purchased from MMFs. Therefore, MMFs did not directly “use” or “participate” in the facility. Nevertheless, throughout this article, we will employ those terms to reflect the fact that the MMLF was set up to “assist money market funds in meeting demands for redemptions by households and other investors, enhancing overall market functioning and credit provision to the broader economy” (Federal Reserve Board press release, March 18, 2020, <https://www.federalreserve.gov/newsevents/pressreleases/monetary20200318a.htm>).

⁴ The remaining 3 percent was held by tax-exempt funds (see endnote 2).

⁵ The SEC adopted an initial, more limited, set of regulatory changes of the MMF industry in 2010.

⁶ Weekly liquid assets include cash, U.S. Treasury securities, certain other government securities that mature within sixty days, and securities that mature or are puttable within five business days. For more details, see <https://www.sec.gov/news/press-release/2014-143>.

⁷ In the EU, offshore government MMFs are referred to as “public debt” funds; offshore prime MMFs are divided in three subgroups: low-volatility NAV funds (the largest group), short-term variable (that is, floating) NAV funds, and standard variable NAV funds.

⁸ See <https://www.immfa.org/market-statistics/immfa-aum.html>

⁹ For more details, see <https://eur-lex.europa.eu/eli/reg/2017/1131/oj>.

¹⁰ Our daily data on MMF flows are from iMoneyNet, which, at the end of 2019, covered 82 percent of the industry.

¹¹ The Reserve Primary Fund was a large prime MMF that suspended redemptions and faced a lengthy liquidation due to losses on its holdings of Lehman Brothers debt. “Breaking the buck” means that a stable-NAV fund reprices its shares at an NAV that reflects the market-based value of its portfolio; this can happen if the market value of its portfolio drops below \$0.995 per share.

¹² Concerns that fees and gates might trigger preemptive runs were raised at the time the SEC proposed the new regulation (see Rosengren 2013 and Cipriani et al. 2014).

¹³ See <https://www.federalreserve.gov/newsevents/pressreleases/monetary20200318a.htm>.

¹⁴ Eligible collateral was valued at either amortized cost or fair value, depending on the collateral type. CP, ABCP, CDs, and U.S. municipal short-term debt, including VRDNs, were valued at amortized cost. For more information on eligible borrowers, eligible assets, and eligible lenders, see the MMLF term sheet at <https://www.federalreserve.gov/monetarypolicy/mmlf.htm>.

¹⁵ In extending emergency credit, the Federal Reserve Board’s practice is to set the interest rate at a penalty rate that is designed to encourage borrowers to repay the loans quickly. See <https://www.federalreserve.gov/newsevents/pressreleases/bcreg20151130a.htm>.

¹⁶ See <https://www.federalregister.gov/documents/2020/03/23/2020-06156/regulatory-capital-rule-money-market-mutual-fund-liquidity-facility>.

NOTES (CONTINUED)

¹⁷ In 2010, the Dodd-Frank Act modified Section 13(3) of the Federal Reserve Act. Among other things, the amendments mandated that any emergency lending facilities authorized by the Federal Reserve under Section 13(3) must be approved by the Secretary of the Treasury. See https://www.federalreserve.gov/monetarypolicy/bsd-appendex_201508.htm.

¹⁸ One difference relative to the MMLF is that the maturity of an AMLF loan (and the remaining term of the collateral) was capped at 120 days for depository institutions and 270 days for nondepository institutions. A second difference is that the rate on an AMLF loan was equal to the PCR offered by the Federal Reserve Bank of Boston at the time the loan was made, without any premium.

¹⁹ Specifically, the fund must have experienced either: (1) a single-day net redemption that exceeded at least 5 percent of the fund's net assets on any given day during the five business days preceding AMLF usage, or (2) multiple-day net redemptions over the course of five or fewer business days that exceeded at least 10 percent of the fund's net assets.

²⁰ The statistics on usage in Chart 4 include assets pledged by both prime and tax-exempt funds.

²¹ The facility usage relative to total assets was about 10 percent under the AMLF and slightly below 8 percent under the MMLF (Anadu and Sanders 2021). In dollar terms, MMLF pledges in 2020 were significantly smaller than AMLF pledges in 2008 because the size of the prime-MMF industry shrank by more than \$1 trillion from November 2015 to October 2016 in response to the 2014 SEC reform (Cipriani and La Spada 2021).

²² Although their eligibility was announced on March 23, CDs and VRDNs could not be pledged at the MMLF until March 25 or later.

²³ From this point on, we merge the data on the MMLF with iMoneyNet data on MMFs. Sixty-seven transactions (out of 1,507), accounting for \$4.4 billion of MMLF loans (7.5 percent of the total), are with four funds that are not listed in iMoneyNet and are dropped from the empirical analysis.

²⁴ Participating funds also had slightly lower WLA, but the difference is not statistically significant because retail funds, which suffered smaller outflows and had fewer incentives to use the facility, tend to have lower WLA (see Chart 6).

²⁵ In addition to improving funds' liquidity position through this direct channel, the MMLF also did so through an indirect channel: as the MMLF slowed the run on the industry, funds had the time needed to let their less-liquid assets mature so that they could then use the proceeds to buy more-liquid assets.

²⁶ The average WLA of institutional prime MMFs went from 42 percent at the end of February to 49 percent at the end of April. The fund on the 95th percentile of the WLA distribution increased its WLA even more, from 52 percent to 65 percent.

²⁷ The average WLA of retail funds went from 41 percent at the end of February to 51 percent by the end of April, and the fund at the 95th percentile of the distribution boosted its WLA by more than 20 percentage points, from 52 percent to 79 percent.

²⁸ To calculate the remaining maturity of the securities held by prime MMFs at the end of February 2020, we use security-level data from SEC's Form N-MFP.

²⁹ Illiquid assets such as CDs and CP enter the calculation of a fund's WLA only when their remaining maturity is five days or less.

³⁰ A description of the Federal Reserve's policy tools, including the 2020 liquidity and credit facilities, can be found at <https://www.federalreserve.gov/monetarypolicy/policytools.htm>.

³¹ Li et al. (2020) also find evidence that the MMLF slowed the run by comparing the post-MMLF flows of domestic MMFs, which were eligible to use the MMLF, with those of offshore funds, which were not.

³² March 18, 2020, Federal Reserve Board press release.

REFERENCES

- Anadu, K., and S. Sanders.* 2021. “Money Market Mutual Funds: Runs, Emergency Liquidity Facilities, and Potential Reforms.” Federal Reserve Bank of Boston SUPERVISORY RESEARCH AND ANALYSIS NOTES 21, no. 3 (May). <https://www.bostonfed.org/publications/supervisory-research-and-analysis-notes/2021/money-market-mutual-funds-runs-emergency-liquidity-facilities-and-potential-reforms.aspx>.
- Cipriani, M., and G. La Spada.* 2020. “Sophisticated and Unsophisticated Runs.” Federal Reserve Bank of New York STAFF REPORTS, no. 956, December.
- Cipriani, M., and G. La Spada.* 2021. “Investors’ Appetite for Money-Like Assets: The MMF Industry after the 2014 Regulatory Reform.” JOURNAL OF FINANCIAL ECONOMICS 140, no. 1 (April): 250-69.
- Cipriani, M., A. Martin, P. McCabe, and B.M. Parigi.* 2014. “Gates, Fees, and Preemptive Runs.” Federal Reserve Bank of New York STAFF REPORTS, no. 670, April.
- Duygan-Bump, B., P. Parkinson, E. Rosengren, G. Suarez, and P. Willen.* 2013. “How Effective Were the Federal Reserve Emergency Liquidity Facilities? Evidence from the Asset-Backed Commercial Paper Money Market Mutual Fund Liquidity Facility.” JOURNAL OF FINANCE 68, no. 2 (April): 715-37.
- Li, L., Y. Li, M. Macchiavelli, and X. Zhou.* 2021. “Liquidity Restrictions, Runs, and Central Bank Interventions: Evidence from Money Market Funds.” REVIEW OF FINANCIAL STUDIES 34, no. 11 (November): 5402-37.
- Rosengren, E.* 2013. “Re: Securities and Exchange Commission’s Money Market Fund Reform; Amendments to Form PF (the “Proposal”), SEC File No. S7-03-13, 78 FR 36833, June 5, 2013.” Comment letter to the Securities and Exchange Commission on behalf of Federal Reserve Bank presidents, September 12. <https://www.sec.gov/comments/s7-03-13/s70313-111.pdf>.

THE TERM ASSET-BACKED SECURITIES LOAN FACILITY

Elizabeth Caviness, Asani Sarkar, Ankur Goyal, and Woojung Park

OVERVIEW

- Asset-backed securities (ABS) have historically played an important role in keeping a healthy supply of credit to households and businesses, funding a substantial share of auto, student, credit card, and small business loans.
- The economic downturn emanating from the COVID-19 pandemic disrupted this securitization market, and financial markets more broadly, resulting in higher spreads and a sharp decline in issuance.
- This study reviews the implementation, utilization, and market impact of the Term Asset-Backed Securities Loan Facility (TALF), a financial-crisis-era tool resurrected by the Federal Reserve in the pandemic response.
- The authors find that both the introduction of the TALF and its subsequent expansion were associated with statistically significant declines in the spreads of ABS securities that were eligible for TALF loans versus those that were not. However, the available data do not show evidence of a statistically significant effect on issuance.

The asset-backed securities (ABS) market, by backing loans to households and businesses such as credit card and student loans, provides essential support to the flow of credit in the economy. The COVID-19 pandemic disrupted this market, resulting in higher spreads on ABS and briefly halting issuance of most ABS asset classes. On March 23, 2020, the Federal Reserve established the Term Asset-Backed Securities Loan Facility (TALF) to facilitate issuance of ABS backed by a variety of loan types including auto loans, credit card loans, and loans guaranteed by the Small Business Administration (SBA), thereby re-enabling the flow of credit to households and businesses.¹ The TALF ceased extending credit on December 31, 2020.

An earlier version of the TALF was announced in 2008 and implemented successfully during the global financial crisis (GFC). In this article, “the TALF” denotes the 2020 version, while we use TALF 1.0 to refer to the GFC version of the program. In Section 1, we describe how the TALF worked, how much it was used, and its effects on the issuance and spreads of TALF-eligible securities relative to those of TALF-ineligible securities. Section 2 documents that both

Elizabeth Caviness is an associate director and Woojung Park a policy and market monitoring principal in the Federal Reserve Bank of New York's Markets Group. Asani Sarkar is a financial research advisor in the Bank's Research and Statistics Group. Ankur Goyal is a supervising examiner in the Bank's Supervision Group. Emails: elizabeth.caviness@ny.frb.org, asani.sarkar@ny.frb.org, ankur.goyal@ny.frb.org, woojung.park@ny.frb.org

The views expressed in this article are those of the authors and do not necessarily reflect the position of the Federal Reserve Bank of New York or the Federal Reserve System. To view the authors' disclosure statements, visit https://www.newyorkfed.org/research/epr/2022/epr_2022_TALF_caviness.

the introduction of the TALF and its subsequent expansion were associated with statistically significant declines in the spreads of TALF-eligible ABS relative to TALF-ineligible ABS. However, the facility did not have a statistically significant effect on issuance. In Section 3, we compare the two versions of the program and discuss the lessons learned from implementing the program a second time. Section 4 concludes.

1. CONDITIONS IN SECURITIZATION MARKETS AROUND THE PANDEMIC CRISIS

When financial firms provide loans to borrowers, they may keep and fund the loans on their balance sheets until loans are repaid or may securitize the loans by financing them off their balance sheets. In a securitization, large numbers of loans are pooled and used as collateral to issue ABS backed by the principal and interest payments on the loans (see Exhibit 1). Further, the cash flows from the loan pools are divided into multiple tranches with different risk characteristics and ratings, allowing investors such as asset managers, insurance companies, or commercial banks to buy the tranches that meet their capacity and willingness to bear risk. For example, risk-averse investors may choose to buy only the AAA-rated tranche of a securitization. Financial firms typically sell the loans to a separate, bankruptcy-remote entity known as a special purpose vehicle (SPV) that holds the loans and issues securitized debt, freeing up their capacity to make new loans.²

The importance of securitization as a funding source is evident in the large volume of ABS issued in 2019, when more than \$300 billion was brought to market. After a seasonal lull in December 2019, ABS issuance was on the upswing in January and February of 2020 (see Chart 1). However, beginning in March 2020, as coronavirus cases surged and authorities imposed social distancing and shutdowns, the economic outlook became highly uncertain, disrupting financial markets. Total ABS issuance declined more than 70 percent from February to April 2020.

Along with declines in issuance, the spreads on the ABS spiked, reflecting both the heightened credit risk from loan losses and liquidity risk as investors ran short of cash (see Chart 2).

EXHIBIT 1

How Asset-Backed Securities Are Created

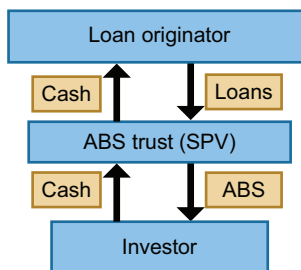

Notes: The chart provides a simplified illustration of how an asset-backed security (ABS) is issued. SPV is special purpose vehicle.

CHART 1

Issuance of Asset-Backed Securities (ABS): Jan 2019 to May 2020

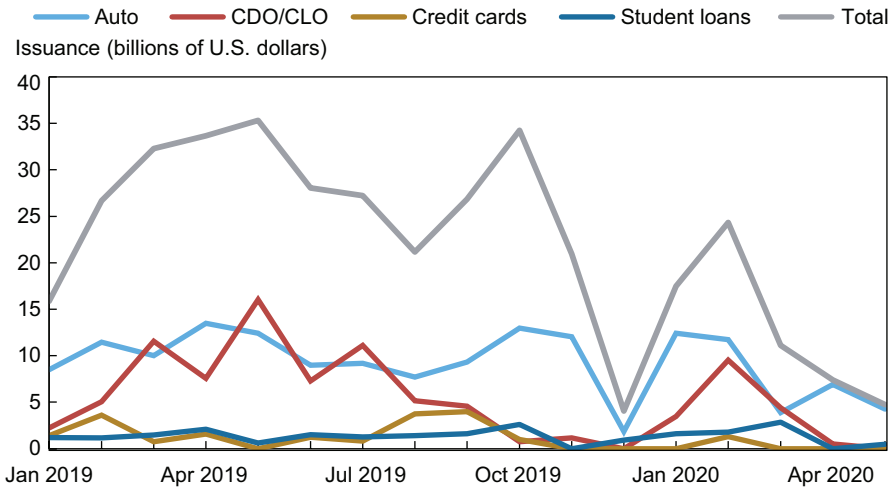

Source: SIFMA. <https://www.sifma.org/resources/research/us-abs-issuance-and-outstanding/>.

Notes: The chart shows issuance of select ABS sectors. CDO is collateralized debt obligation. CLO is collateralized loan obligation.

CHART 2

Spreads on AAA-Rated ABS Tranches

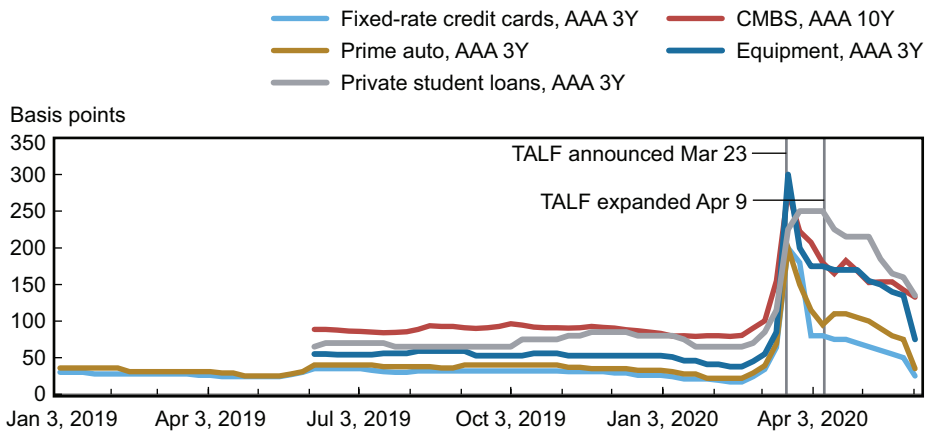

Source: Data are from Bloomberg L.P.

Notes: TALF is Term Asset-Backed Securities Loan Facility. ABS is asset-backed security.

For example, between February 20 and March 19, spreads on AAA-rated tranches of commercial mortgage-backed securities (CMBS) with ten-year maturity increased by almost 200 basis points to about 280 basis points and spreads on AAA-rated tranches of

three-year maturity prime auto loan ABS widened by almost 180 basis points to 200 basis points.

Since the ABS market has historically funded a significant portion of consumer and business lending, continued disruption of these markets—and of financial markets more broadly—had the potential to strain the liquidity and balance sheet capacity of financial institutions and hamper the flow of credit to consumers and businesses by limiting the ability of those institutions to make loans.³

1.1 The Establishment of the TALF

To facilitate the issuance of ABS, stabilize ABS markets generally, and support the continued availability of credit to households and businesses, the Federal Reserve Board authorized the New York Fed to establish the TALF under the authority of Section 13(3) of the Federal Reserve Act, with the prior approval of the Secretary of the Treasury.⁴ The initial size of the facility was \$100 billion, supported by \$10 billion of equity authorized by the U.S. Department of the Treasury, using funds appropriated to the Exchange Stabilization Fund by Congress under section 4027 of the Coronavirus Aid, Relief, and Economic Security Act (“CARES Act”).⁵

1.2 What Did the TALF Do and How Did It Do It?

The TALF was designed to facilitate the issuance of ABS backed by new or recently originated consumer and small business loans, leveraged loans, and commercial mortgages. The New York Fed lent to a special purpose vehicle (TALF SPV), which provided funding to eligible borrowers owning eligible ABS (see Exhibit 2).⁶ The TALF lent an amount equal to the market value of the ABS, less a haircut to compensate for the collateral’s credit risk. The loan was secured at all times by the ABS. By offering TALF loans to investors to purchase new or recently issued ABS, the facility provided liquidity to securitization markets and thereby facilitated the issuance of new ABS. In turn, financial firms that sell ABS to investors were able to free up capacity to continue lending to households and businesses.

The TALF contained several features intended to protect taxpayers from losses under adverse economic conditions. For an ABS to be eligible for a TALF loan, it needed a AAA credit rating from at least two rating agencies. Since AAA-rated tranches are the safest and largest in securitizations, limiting eligibility to these tranches allowed the TALF to have the greatest effect on market functioning while minimizing credit risk assumed by the Federal Reserve. In addition, TALF borrowers were required to post a haircut that ranged from 5 to 25 percent, depending on the asset class and average life of the securities. Haircuts were calculated as a percentage of the underlying value of the ABS, implying that the TALF SPV would not take a loss unless the price of the pledged ABS declined more than the haircut. The TALF only accepted underlying assets or ABS structural features that were relatively simple and safe in order to further reduce the risk of loss to taxpayers.⁷

Approximately twice each month, borrowers were able to request one or more three-year TALF loans. TALF loans were nonrecourse to the ABS investor—that is, if the investor did not repay the loan, remedies for the TALF SPV were limited to enforcing its rights in the

EXHIBIT 2

How the TALF Worked

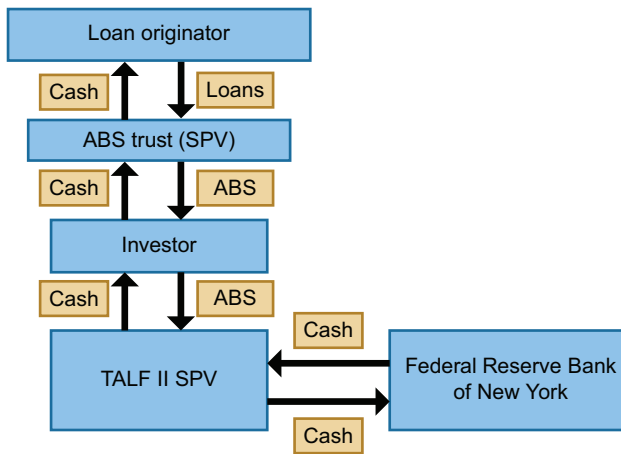

Notes: The chart provides a simplified illustration of how investors borrow from the Term Asset-Backed Securities Loan Facility (TALF) using an asset-backed security (ABS). SPV is special purpose vehicle.

collateral—a feature that is atypical of ABS market financing under normal conditions. To provide more support under stressed than under normal market conditions, the TALF made loans at a premium over the rate that would prevail under normal market conditions. TALF loan interest rates were determined by the type of collateral securing the loan. For example, when collateralized loan obligations (CLOs) were provided as collateral, the rate was 150 basis points plus the thirty-day average of the secured overnight financing rate (SOFR). As of December 31, 2020, the TALF closed for new loan extensions.

1.3 To What Extent Was the TALF Utilized?

Since TALF loan terms were designed to be attractive during periods of stress but not at other times, its utilization tracked the recovery of securitization markets—that is, the TALF was used extensively during the crisis but less so when the markets recovered. Moreover, the majority of TALF borrowers were not traditional investors in AAA-rated ABS, such as insurance companies, but return-sensitive investors who viewed the facility as a temporary investment opportunity (Covitz, Meisenzahl, and Pence 2021). The activities of these return-sensitive investors facilitated the restoration of securitization market functioning, in line with the objectives of the TALF.

Covitz, Meisenzahl, and Pence (2021) document three types of return-sensitive investors in the TALF that accounted for 83 percent of all loans: TALF-only funds, fixed-life partnerships, and hedge funds with TALF-only borrowers. TALF-only funds were investment vehicles established by asset managers for the express purpose of borrowing from the TALF on behalf of their investors. Immediately following the announcement of the TALF, market participants expected TALF returns similar to those of TALF 1.0, ranging from high single digits to mid-teens for

AAA risk in asset classes including subprime auto, private student loans, auto floor plan, and auto lease ABS, with estimates of expected utilization of TALF loans between \$30 billion and \$50 billion.⁸ These projected yields generated a lot of interest from market participants and there was aggressive marketing of TALF-only strategies designed to generate return by utilizing TALF financing (assumed to be cheaper than market financing). However, tighter spreads following the announcement of the TALF made TALF-only strategies less attractive.

TALF loans requested by asset class at each subscription are reported in Table 1. Small business and commercial mortgage were the most popular securitization sectors backing loan requests. In contrast, no loans were requested in the credit card, equipment, and floorplan sectors. By the time of the first TALF subscription on June 17, ABS spreads had tightened to the point that estimated TALF returns were in the low single digits. Market participants expected low TALF utilization for most traditional AAA-rated TALF-eligible ABS, such as prime auto loans and credit cards, because of unattractive TALF yields. Consistent with this interpretation, TALF utilization was dominated by legacy CMBS and SBA securitizations, markets where spread tightening occurred more slowly.

2. HOW DID MARKETS RESPOND TO THE ANNOUNCEMENT OF THE TALF?

The liquidity backstop provided by the TALF appears to have played a key role in restoring investor confidence at a time of great uncertainty, mitigating fears that spreads would widen even before the program began operating. ABS spreads improved quickly following the TALF announcement as spreads tightened sharply across asset classes between March 23 and April 9. Issuance was slower to recover, with the pace of activity only picking up in the second half of 2020. TALF liquidity provided limited support to securitization issuance since, without increased economic activity, generation of new loans was naturally constrained.

2.1 Improvements in Market Functioning

In Table 2, we provide snapshots of the funding and liquidity conditions of secured financing markets during the pandemic, as well as changes attributable to the TALF, using the Fed's Senior Credit Officer Opinion Survey (SCOOS) on Dealer Financing Terms.⁹ The survey collects qualitative information on changes in credit terms and conditions in securities financing from twenty-three participants that account for almost all dealer financing of dollar-denominated securities to nondealers. The surveyed participants are the most active intermediaries in over-the-counter derivatives markets.¹⁰

The Q2 2020 survey indicated worsening secured funding terms and liquidity conditions for most dealers in ABS market transactions from February to May 2020. A majority of dealers reported heightened funding demand, as well as worsening funding terms (such as haircuts) and liquidity conditions in ABS markets. In contrast, about half of dealers in the Q3 2020 survey indicated "easing of funding terms with respect to haircuts and collateral spreads for both average and most-favored clients." Strikingly, in consumer ABS (among the

TABLE 1
TALF Loans Requested at Each Subscription
 Amount (millions of U.S. dollars)

Sector	Subscription Dates											
	Jun 17	Jul 6	Jul 21	Aug 4	Aug 19	Sep 3	Sep 18	Oct 6	Oct 21	Nov 5	Nov 24	Dec 10
Auto	-	-	-	-	-	-	-	-	-	-	-	-
Commercial mortgage	145	224	331	113	169	112	20	32	46	-	-	-
Credit card	-	-	-	-	-	-	-	-	-	-	-	-
Equipment	-	-	-	-	-	-	-	-	-	-	-	-
Floorplan	-	-	-	-	-	-	-	-	-	-	-	-
Leveraged loan	-	-	-	-	-	-	-	-	328	-	-	152
Premium finance	56	51	-	-	-	-	-	-	-	-	-	-
Small business	51	440	453	487	214	161	290	162	220	-	345	66
Student loan	-	8	200	46	-	10	-	-	-	26	-	-
Total	252	723	984	646	383	283	310	194	594	26	345	218

Source: Federal Reserve Bank of New York. Term Asset-Backed Securities Loan Facility Rates. TALF rates. <https://www.newyorkfed.org/markets/term-asset-backed-securities-loan-facility/term-asset-backed-securities-loan-facility-rates>.

Note: Dates are in 2020.

TABLE 2

Funding and Liquidity Conditions in Secured Financing Markets: 2020-21

Panel A: Demand for Funding of Securitized Financing Transactions

Survey Dates: When Conducted, Period of Change	Securities Referenced	Increased or Decreased?	Share of Dealers Responding Increased/Decreased
Feb 11–25, 2020 Dec 2019–Feb 2020	Non-agency RMBS	Increased	Small
May 5–18, 2020 Feb–May 18, 2020	Non-agency RMBS, CMBS, and consumer ABS	Increased	>50 percent
Aug 11–20, 2020 Mid-May–Mid-Aug 2020	Non-agency RMBS and CMBS Consumer ABS	Increased No change	Small Small
Nov 10–26, 2020 Sep–Nov 2020	CMBS	Increased	About 20 percent
Feb 8–22, 2021 Dec 2020–Feb 2021		No change	

Panel B: Funding Terms (Haircuts, Collateral Spreads, Max Funding Amounts, and Maturity)

Survey Dates: When Conducted, Period of Change	Securities Referenced	Better or Worse?	Share of Dealers Responding Better/Worse
Feb 11–25, 2020 Dec 2019–Feb 2020		No change	
May 5–18, 2020 Feb–May 18, 2020	Non-agency RMBS, CMBS, and consumer ABS	Worse	Most
Aug 11–20, 2020 Mid-May–Mid-Aug 2020	Consumer ABS	Better	About 50 percent
Nov 10–26, 2020 Sep–Nov 2020	CMBS	Better	Over 50 percent
Feb 8–22, 2021 Dec 2020–Feb 2021	Non-agency RMBS CMBS Consumer ABS	Better Better Better	About 60 percent About 50 percent About 80 percent

Panel C: Liquidity Conditions

Survey Dates: When Conducted, Period of Change	Securities Referenced	Better or Worse?	Share of Dealers Responding Better/Worse
Feb 11–25, 2020 Dec 2019–Feb 2020	Non-agency RMBS and consumer ABS	Better	Small
May 5–18, 2020 Feb–May 18, 2020	Consumer ABS Non-agency RMBS and CMBS	Worse Worse	>50 percent >80 percent
Aug 11–20, 2020 Mid-May–Mid-Aug 2020	Consumer ABS CMBS and non-agency RMBS	Better Better	About two-thirds About 50 percent
Nov 10–26, 2020 Sep–Nov 2020	Consumer ABS	Better	About one-third
Feb 8–22, 2021 Dec 2020–Feb 2021	Non-agency RMBS and consumer ABS	Better	About one-third

Source: Senior Credit Officer Opinion Survey (SCOOS) on Dealer Financing Terms, Q1:2020–Q1:2021.

Notes: ABS is asset-backed security. CMBS is commercial mortgage-backed security. RMBS is residential mortgage-backed security.

TABLE 3

The Effect of the TALF on Funding and Liquidity Conditions in Secured Financing Markets

Survey Dates: When Conducted, Period of Change	Changes Relative to Mid-March in Non-agency CMBS	
	Funding Terms (Share of Dealers; Higher/Lower; Term Type; TALF-Eligibility)	Liquidity Conditions (Share of Dealers; Better/Worse; TALF Eligibility)
Aug 11 – 20, 2020	About 50 percent; lower; collateral spreads; TALF-eligible and ineligible	About one-third; better; TALF- eligible
Mid-May–Mid-Aug 2020	About 25 percent; lower; haircuts; TALF-eligible and ineligible About one-third; higher; max funding amount and maturity; TALF-eligible and ineligible	Same; TALF-ineligible

Source: Senior Credit Officer Opinion Survey (SCOOS) on Dealer Financing Terms, Q3:2020.

Notes: TALF is Term Asset-Backed Securities Loan Facility. CMBS is commercial mortgage-backed security.

worst-affected sectors during the pandemic), about two-thirds of dealers reported better liquidity conditions between mid-May and mid-August of 2020. That contrasts with the more than 50 percent of dealers who reported worse liquidity conditions during the crisis period between February and May 18, 2020. Dealers continued to report better funding and liquidity conditions in the fourth quarter of 2020 and the first quarter of 2021.

The Q3 2020 survey also asked dealers to compare funding and liquidity conditions for TALF-eligible and TALF-ineligible CMBS relative to mid-March 2020 conditions. Table 3 summarizes these responses. The dealers indicated improved funding terms independent of TALF eligibility, and they reported lower collateral spreads and haircuts, and greater and longer maturity funding amounts. Further, the dealers reported better liquidity conditions for TALF-eligible CMBS relative to TALF-ineligible CMBS.

2.2 Improvements in ABS Spreads due to the TALF

The announcement of the TALF on March 23 appears to have provided a backstop for securitization market pricing and helped to normalize ABS spreads, as Chart 3 shows. For example, between March 23 and April 9, spreads on AAA-rated, five-year tranches of CMBS dropped from 300 basis points to 185 basis points, and AAA-rated, three-year maturity tranches of primary auto loan ABS dropped from 200 basis points to 95 basis points. However, spreads on some less-liquid ABS asset classes, such as subprime auto loans and student loans, remained elevated.

On April 9, the asset classes eligible for the TALF were expanded to include certain types of CMBS and CLOs.¹¹ Spreads on these new TALF-eligible asset classes had already tightened following the initial TALF announcement and they tightened further following announcement of the expansion. Interestingly, spreads on ABS asset classes that had not improved following the TALF announcement on March 23 also fell after the expansion of the TALF and

CHART 3

AAA Securitization Spreads

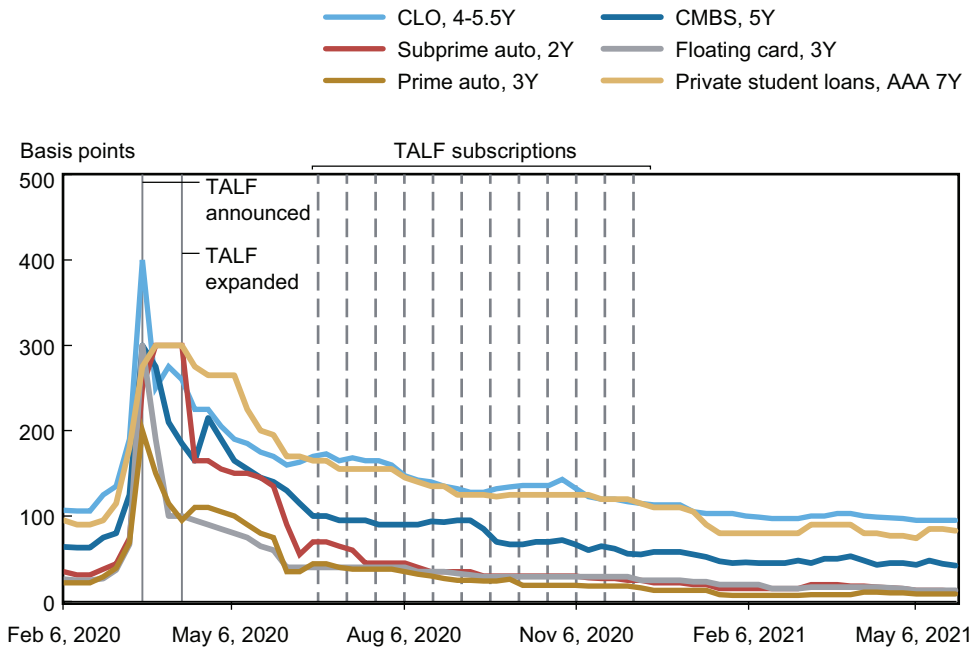

Sources: Courtesy J.P. Morgan Chase & Co., Copyright 2021; authors' calculations.

Notes: The chart shows the spreads of select asset-backed securities between February 2020 and May 2021. CLO is collateralized loan obligation. CMBS is commercial mortgage-backed security. TALF is Term Asset-Backed Securities Loan Facility.

announcement of new Fed actions on April 9.¹² For example, spreads on AAA tranches of ABS backed by subprime auto loans dropped from 300 basis points in the week of April 9 to 165 basis points in the following week. Student loan spreads plateaued and gradually decreased. As TALF subscriptions continued in 2020, ABS spreads kept narrowing. By December 31, 2020, when the TALF closed for new loan extensions, spreads were close to pre-pandemic levels.

It is challenging to identify the effects of the TALF on ABS spreads in the context of market volatility and the macro policy changes that occurred during our sample period. Further, the Fed announced a slew of additional measures on March 23 to support households, businesses, and the U.S. economy.¹³ To better isolate TALF effects, we perform a statistical analysis, estimating regressions to compare spread changes of TALF-eligible and ineligible securities (See Box 1 for a formal description of the regressions used in this study). Further, we use time-fixed effects which absorb all purely time-series variations in spreads—for example, those induced by market and macro factors. Finally, we use ABS security fixed effects to absorb all purely security-specific factors (for example, contractual features specific to a security). This ensures that the only difference between the two groups of securities under comparison is their TALF eligibility. Since the TALF-eligible securities could not qualify for any other Fed

Box 1

Regression Specifications

In this box, we describe the regressions used to estimate announcement effects on TALF-eligible relative to TALF-ineligible securities.

Spread Regressions

We estimate the following panel regression for security “*s*” and week “*t*”:

$$\begin{aligned} \Delta Spread_{s,t} = & \alpha_0 + \alpha_s + \alpha_t + \beta_1 MarchAnn_t * TALFEligible - ExCLOCMBS_s + \beta_2 MarchAnn_t * CLOCMBS_s \\ & + \beta_3 AprAnn_t * TALFEligible - ExCLOCMBS_s + \beta_4 AprAnn_t * CLOCMBS_s + \beta_5 DecAnn_t * \\ & TALFEligible - ExCLOCMBS_s + \beta_5 DecAnn_t * CLOCMBS_s + \gamma_0 Subscriptions_t * \\ & TALFEligible_s + \varepsilon_{s,t} \end{aligned} \quad (1)$$

$\Delta Spread$ is the change in the spread of ABS security “*s*” from the prior week, and α_s and α_t are the security and time period fixed effects, respectively. The remaining regressors are dummy variables defined as follows:

- $TALFEligible-exCLOCMBS = 1$ for TALF-eligible securities except CLO and CMBS, and 0 otherwise,
- $CLOCMBS = 1$ for TALF-eligible CLO and CMBS and 0 otherwise,
- $TALFEligible = 1$ for all TALF-eligible securities, and 0 otherwise,
- $MarchAnn = 1$ on March 23, 2020, and 0 otherwise,
- $AprAnn = 1$ on April 9, 2020, and 0 otherwise,
- $DecExp = 1$ on December 31, 2020, and January 7, 2021, and 0 otherwise, and
- $Subscriptions = 1$ for TALF subscription dates (see Table 1) and 0 otherwise.

The regression is estimated with ordinary least squares (OLS) and the results are reported in Table 4. *T*-statistics based on robust standard errors are reported in parentheses.^a

Issuance Regressions

We estimate the following regression for security “*s*” and month “*t*”:

$$\begin{aligned} \Delta Issuance_{s,t} = & \alpha_0 + \alpha_s + \alpha_t + \beta_1 March2020_t * TALFEligible - ExCLOCMBS_s + \beta_2 March2020_t * CLOCMBS_s \\ & + \beta_3 Apr2020_t * TALFEligible - ExCLOCMBS_s + \beta_4 Apr2020_t * CLOCMBS_s + \beta_5 Dec2020_t * \\ & TALFEligible - ExCLOCMBS_s + \beta_6 Dec2020_t * CLOCMBS_s + \gamma_0 SubscriptionMonths_t * \\ & TALFEligible_s + \varepsilon_{s,t} \end{aligned} \quad (2)$$

$\Delta Issuance$ is the change in the issuance of ABS security “*s*” from the prior month, and α_s and α_t are the security and time period fixed effects, respectively. The announcement, expiration, and subscription dummies have been replaced by the relevant month dummies. The eligibility dummies are defined in the same manner as before.

^a Specifically, we use the White period method that assumes errors for a cross-section are heteroskedastic and serially correlated.

program, our estimates are likely mostly to identify the effects of the TALF announcements and not those of other Fed announcements.

A list of TALF-eligible and TALF-ineligible securities used in the analysis is provided in Appendix 1.

Results from the regressions are reported in Table 4. Column 1 of the table reports results when omitting the fixed effects. We find that, following the March 23 announcement, spreads of all TALF-eligible securities declined significantly relative to securities not qualifying for the TALF. Even spreads of CLO and CMBS securities that were not TALF-eligible at the time but became eligible subsequently decreased by almost 90 basis points. This result might suggest that markets anticipated these securities would be included in the TALF. There is no evidence of a broader spillover to ABS markets since the standalone March announcement dummy is not significant. Following the April 9 announcement, the spreads of CLO and CMBS securities that became eligible declined a further 20 basis points, with no further declines in other TALF-eligible securities. The April announcement dummy is negative and significant, which may suggest a broad decline in ABS spreads on this day, but this result is obtained without accounting for security-specific characteristics. We discuss the results for TALF subscriptions and the December expiration event below.

In column 2 of Table 4, we add the security fixed effects and find that the results are mostly unchanged. This means that the better performance of TALF-eligible securities is due to their eligibility feature and not other differences with TALF-ineligible securities. One exception is that the April announcement dummy is no longer significant, indicating that the prior result was due to differences in security characteristics unrelated to TALF. In column 3 of the table, we further add the time fixed effects which absorb all purely time-series variations, including the standalone announcement effects, and so the latter can no longer be estimated separately. Once again, the results are essentially unchanged, indicating that they are not driven by market and macro factors such as volatility and government policy changes.

By the time TALF subscriptions began, ABS spreads had already declined substantially and so further spread tightening on subscription dates may seem unlikely. Indeed, columns 1 to 3 of the table show that spreads of TALF-eligible securities do not experience incremental tightening on subscription dates. However, there appears to be a general decline in ABS spreads on these dates as the TALF subscription dummy is negative and significant in columns 1 and 2. We explore the idea that subscribed TALF-eligible securities benefitted from lower spreads on subscription dates. To this end, in column 4 of the table, we interact a dummy variable for TALF-subscribed securities with a dummy variable for the subscription date (see Table 1 for the subscriptions data). These results show that TALF-subscribed securities experienced additional moderate tightening on some dates (such as June 17, September 18, October 6, and October 21). One exception is August 19, when spreads of the CMBS security—the only one in our data that was subscribed to on that day—increased significantly. A possible explanation for this result is that market liquidity is generally poor in summer and CMBS liquidity worsened more relative to other ABS securities on August 19.

Importantly, we do not find significant spread increases for TALF-eligible securities in the weeks before and after December 31, 2020, when the TALF ceased making new loans once we include the security fixed effects (see column 2 of the table).¹⁴ On the contrary, the average spread of ABS securities *decreases* on the December expiration date, as suggested by the negative and significant estimate of the December expiration event dummy. Indeed, in the first

TABLE 4
The Effect of the TALF on Changes in ABS Spreads

	(1)	(2)	(3)	(4)
Mar 23 Announcement	0.81 (0.06)	1.33 (0.09)		
Mar 23 Announcement x TALF ex CLO and CMBS	-43.93* (-1.89)	-44.62* (-1.88)	-44.62* (-1.83)	-44.65* (-1.83)
Mar 23 Announcement x CLO and CMBS	-88.93* (-1.86)	-90.65* (-1.87)	-90.65* (-1.81)	-90.86 (-1.82)
Apr 9 Announcement	-0.62** (-2.27)	-0.09 (-0.22)		
Apr 9 Announcement x TALF ex CLO and CMBS	-2.50 (-1.03)	-3.19 (-1.27)	-3.19 (-1.23)	-3.22 (-1.24)
Apr 9 Announcement x CLO and CMBS	-20.00*** (-5.46)	-21.72*** (-6.98)	-21.72*** (-6.79)	-21.93*** (-6.47)
Dec 31 Expiration	-5.12*** (-2.62)	-4.59** (-2.23)		
Dec 31 Expiration x TALF ex CLO and CMBS	3.25* (1.71)	2.56 (1.24)	2.56 (1.20)	
Dec 31 Expiration x CLO and CMBS	1.75 (0.84)	0.03 (0.01)	0.03 (0.01)	
TALF Subscriptions	-3.07*** (-3.33)	-2.55** (-2.30)		
TALF Subscriptions x TALF	0.93 (1.10)	0.03 (0.03)	0.03 (0.03)	0.50 (0.42)
Jun 17 x Jun 17 Subscriptions				-13.04*** (-3.90)
Jul 6 x Jul 6 Subscriptions				-0.45 (-0.55)
Jul 21 x Jul 21 Subscriptions				-2.83 (-1.59)
Aug 4 x Aug 4 Subscriptions				-4.62 (-1.62)
Aug 19 x Aug 19 Subscriptions				6.21*** (6.68)
Sep 3 x Sep 3 Subscriptions				-4.74 (-1.43)
Sep 18 x Sep 18 Subscriptions				-16.91*** (-19.57)
Oct 6 x Oct 6 Subscriptions				-1.54* (-1.76)
Oct 21 x Oct 21 Subscriptions				-1.78*** (-3.12)
Nov 5 x Nov 5 Subscriptions				0.45 (0.39)

(CONTINUED ON NEXT PAGE)

TABLE 4 (CONTINUED)

	(1)	(2)	(3)	(4)
Dec 10 x Dec 10 Subscriptions				1.01 (1.21)
Security fixed effects	No	Yes	Yes	Yes
Time fixed effects	No	No	Yes	Yes
Adjusted R-squared	0.00	0.03	0.73	0.72

Source: Authors' calculations.

Notes: The table reports results from regressions of the changes in asset-backed security (ABS) spreads, using the specification in equation (1). "TALF" denotes a dummy variable for TALF-eligible securities. "TALF ex CLO CMBS" is a dummy variable that excludes collateralized loan obligations (CLO) and commercial mortgage-backed securities (CMBS) from the set of TALF-eligible securities. "CLO and CMBS" indicates a dummy variable for TALF-eligible CLO and CMBS. The sample is from January 2, 2020, to May 31, 2021, and contains 1,224 observations. ***, **, and * indicate significance at the 1 percent, 5 percent, and 10 percent levels, respectively.

two months of 2021, spreads across asset classes continued to tighten following the end of new lending by TALF amid strong investor demand.

In 2021, as the economy continued to reopen, AAA spreads for major securitized asset classes fully retraced their COVID-induced spread widening and reached multi-year lows. Although spreads of lower-rated tranches have not fallen as much relative to those of senior tranches, the gap has continued to narrow. Credit curves, measured as the difference between spreads on senior and junior tranches, have continued to flatten and are now only marginally steeper than they were prior to the pandemic.

2.3 Improvements in ABS Issuance due to the TALF

ABS issuance suffered a broad slowdown in March and April of 2020, but the pace of issuance recovered in the second half of the year for most securitized products, as seen in Chart 4. For example, non-agency CMBS issuance dropped from \$23 billion in the first quarter of 2020 to just \$7 billion in the second quarter before recovering to about \$16.5 billion by the fourth quarter. During the same period, student loan ABS issuance fell from over \$7 billion in the first quarter to about \$3 billion in the second quarter before recovering to \$5.5 billion in the fourth quarter. CDO and CLO issuance fell from \$35 billion in the fourth quarter of 2019 to \$22 billion in the first quarter of 2020 before increasing to \$33.5 billion in the fourth quarter.¹⁵ In addition to TALF, market innovations such as shorter reinvestment periods may also have helped CLO issuance to recover.¹⁶ As a result of the boost in issuance during the second half of 2020, issuance of non-agency securitized products in all of 2020 was about \$460 billion compared to about \$580 billion in 2019—a decline of only about 20 percent compared to the prior year.

Unlike other ABS sectors, issuance of auto ABS—a traditional benchmark ABS sector—remained resilient and steady at between \$26 billion and \$30 billion in the first three quarters of 2020. Auto ABS issuance is in large part related to auto sales volume, which recovered

CHART 4
U.S. Non-Agency Securitization Issuance, 2012:Q2 to 2021:Q1

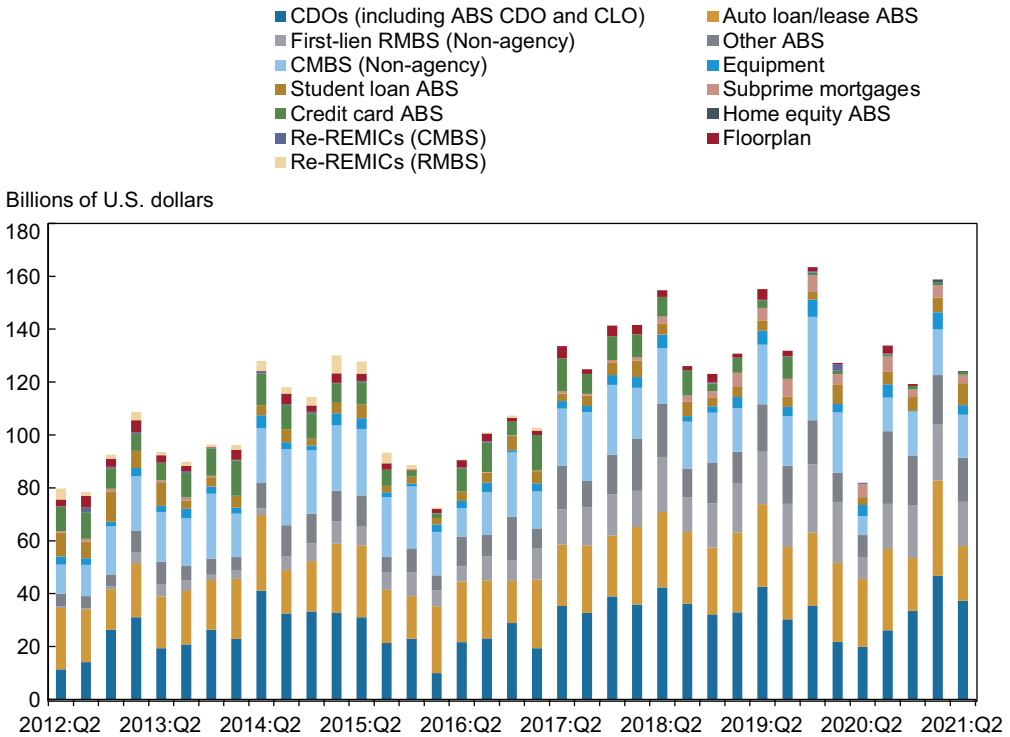

Sources: Asset-Backed Alert’s ABS database; Commercial Mortgage Alert’s CMBS database.

Notes: ABS is asset-backed security. CMBS is commercial mortgage-backed security. RMBS is residential mortgage-backed security. CLO is collateralized loan obligation. CDO is collateralized debt obligation. REMIC is real estate mortgage investment conduit.

rapidly from April 2020. Other reasons for this good performance were debt relief by lenders including deferral, consumer forbearance and loan extensions, and government stimulus and support programs.¹⁷

Like our analysis of ABS spreads, we identify TALF-specific effects by comparing TALF-eligible and TALF-ineligible securities. However, due to inadequate data, the identification of TALF effects on issuance is less precise than the spread analysis. For example, the data are at the monthly frequency, so announcement effects are less precisely determined than when using weekly data. In addition, timing of securitization issuance is complicated by multiple factors, including access to lenders’ other funding sources, the time required to accumulate collateral, and related capital market activities such as the structuring and placement of ABS notes. (Appendix 2 shows the list of eligible and ineligible securities used in the issuance regression.)

Table 5 shows the results of this analysis. When omitting the fixed effects (see column 1 of the table), we find that the standalone March 2020 dummy is negative and significant, indicating ABS issuances decrease significantly in March, as expected. However, issuance

TABLE 5

The Effect of the TALF on Changes in ABS Issuances

	(1)	(2)	(3)	(4)
March Announcement	-2.44*** (-2.88)	-2.45** (-2.76)		
March Announcement x TALF ex CLO and CMBS	0.17 (0.08)	0.16 (0.07)	0.26 (0.11)	0.27 (0.11)
March Announcement x CLO and CMBS	-0.10 (-0.06)	-0.10 (-0.06)	-0.10 (-0.05)	-0.10 (-0.06)
April Announcement	-2.76 (-1.50)	-2.78 (-1.47)		
April Announcement x TALF ex CLO and CMBS	3.48* (1.76)	3.51 (1.73)	3.61 (1.71)	3.60 (1.70)
April Announcement x CLO and CMBS	2.72 (1.49)	2.71 (1.44)	2.70 (1.35)	2.74 (1.37)
December Expiration	0.31 (1.09)	0.30 (1.21)		
December Expiration x TALF ex CLO and CMBS	0.75 (0.74)	0.77 (0.73)	1.00 (0.78)	
December Expiration x CLO and CMBS	0.27 (0.77)	0.27 (0.92)	0.29 (0.90)	
TALF Subscriptions	0.11 (1.44)	0.09 (1.21)		
TALF Subscriptions x TALF	-0.27 (-1.04)	-0.26 (-0.94)	-0.37 (-0.86)	-0.40 (-0.67)
June x June Subscriptions				-2.99** (-2.26)
July x July Subscriptions				-1.46 (-1.48)
August x August Subscriptions				2.59 (1.54)
September x September Subscriptions				-2.21 (-1.18)
October x October Subscriptions				-0.39 (-0.28)
November x November Subscriptions				4.86** (2.72)
December x December Subscriptions				3.81*** (3.64)
Security fixed effects	No	Yes	Yes	Yes
Time fixed effects	No	No	Yes	Yes
Adjusted R-squared	0.00	0.00	0.12	0.12

Source: Authors' calculations.

Notes: The table reports results from regressions of the changes in asset-backed security (ABS) spreads, using the specification in equation (1). "TALF" denotes a dummy variable for TALF-eligible securities. "TALF ex CLO CMBS" is a dummy variable that excludes collateralized loan obligations (CLO) and commercial mortgage-backed securities (CMBS) from the set of TALF-eligible securities. "CLO and CMBS" indicates a dummy variable for TALF-eligible CLO and CMBS. The sample is from January 2, 2020, to May 31, 2021, and contains 1,224 observations. ***, **, and * indicate significance at the 1 percent, 5 percent, and 10 percent levels, respectively.

of TALF-eligible securities is similar to issuance of TALF-ineligible securities, as shown by the insignificant coefficient of the interaction of the March dummy with the TALF-eligibility dummy. Since the March 2020 dummy includes the pre-TALF period when issuances essentially stopped, any positive effect of the TALF on March issuances is difficult to determine. During April 2020, issuances of TALF-eligible CLO and CMBS securities increase significantly relative to TALF-ineligible securities, while issuances of other TALF-eligible securities are similar to those of TALF-ineligible securities. We do not find significant declines in issuances of TALF-eligible securities following the expiration of the program at the end of the fourth quarter of 2020, nor do we find significant effects on issuances of ABS securities generally.

The results are similar after adding the security fixed effects (see column 2 of the table). One difference is that the better issuance performance of TALF-eligible CLO and CMBS securities is no longer significant in April 2020, although the magnitude and *T*-statistics remain similar. The significance of these effects is further reduced after adding the time fixed effects (see column 3 of the table). Thus, the positive April 2020 effects on CLO and CMBS issuance are mainly due to incomplete controls for differences in security characteristics and changes in market and macro factors.

Regarding TALF subscriptions, absent fixed effects (column 1 of the table), issuances of TALF-eligible securities do not increase incrementally on subscription dates. Did TALF-eligible securities that were subscribed to benefit from higher issuance during their subscription months? The result shows that TALF-subscribed securities experienced additional moderate increases during November and December 2020.

In 2021, as the economy continued to reopen, the issuance of ABS approached pre-COVID levels, as deals were oversubscribed, leading to the size of issuances being revised upwards and their offering at yields tighter than initially expected. Through April 2021, as the economy opened further, non-agency securitized product issuance was \$220 billion, about 18 percent higher than in the same period in 2020 and significantly exceeding the five-year average in the 2016-20 period of \$149 billion. Monthly issuance has approached pre-COVID levels and investor demand remains strong, with significant oversubscription and favorable pricing on new transactions.

3. WHAT DID WE LEARN?

The TALF was used and successfully implemented previously during the financial crisis of 2007-09.¹⁸ Even though the 2020 pandemic-induced market volatility was not triggered by stresses in the secured financial markets, unlike in the 2008 crisis, the previous iteration of TALF 1.0 provided a useful template for TALF 2.0. For example, spreads dropped significantly after the March 3, 2009, announcement of the first TALF 1.0 subscription date, which clarified the details of the program (Campbell et al. 2011). New ABS issuance picked up after the first subscription date (Covitz, Meisenzahl, and Pence 2021).¹⁹ The success of TALF 1.0 bolstered market participants' confidence even before the operational details of TALF 2.0 had been worked out. Indeed, unlike TALF 1.0, spreads on ABS dropped immediately after the announcement of TALF 2.0, as we have shown.

While the structure of TALF 2.0 is largely similar to the 2009 program, one notable difference is that CLOs were not included as eligible collateral in TALF 1.0. Consequently, spreads on CLOs did not respond to TALF 1.0 announcements, whereas CLO spreads fell significantly after TALF 2.0 was announced on March 23, 2020—even before AAA-rated CLO tranches were made TALF-eligible.²⁰

While the Fed had operated the TALF previously, there were several lessons learned from the later iteration of the program. The time between the program’s announcement and the first TALF subscription was less than the five-month gap between the announcement and first subscription of TALF 1.0. Still, the three months between announcement and first subscription of TALF 2.0 was considerable, reflecting the new program’s increased operational complexity. One reason is the larger number of TALF-eligible asset classes, which have varying market conventions. Additionally, in TALF 2.0 in 2020, the program held two subscriptions each month at which loan requests for all asset classes were accepted. By contrast, in 2009, the TALF only held one subscription for ABS and one subscription for CMBS each month. The switch to semi-monthly subscriptions further increased the operational complexity of the program.

The 2020 experience also demonstrates the value that the market ascribes to TALF program transparency. ABS market participants knew the basic structure of the TALF and were aware of its success in supporting the market in 2009. When the relaunch of the program was announced in March 2020, market confidence was bolstered and spreads for highly rated securitized products began to tighten immediately and tightened steadily until the TALF began operations. Even after the publication of the first iteration of the TALF Frequently Asked Questions on May 12, spreads for most highly rated securitization tranches did not change materially. The Fed published on the TALF page of its public website the eligibility determination for each CUSIP against which borrowers requested loans at each subscription, which helped borrowers gauge what collateral would be deemed eligible at future subscriptions.

4. CONCLUSION

We review the implementation and market impact of the TALF, one of several liquidity and credit facilities that the Fed created in response to the market dislocation emanating from the COVID-19 pandemic.²¹ The announcement of the TALF resulted in significant improvements in the ABS market’s functioning. Spreads of ABS declined broadly following the announcement of the TALF in March 2020, but spreads of TALF-eligible securities declined even more. Even spreads of CLO and CMBS—instruments that only became eligible for the TALF a month later—narrowed. Moreover, there is evidence that spreads of specific ABS that investors borrowed against in the TALF declined on their subscription dates throughout 2020.

Due to lower frequency data, we are unable to precisely identify TALF effects on ABS issuance. Moreover, if underlying economic activity is subdued, the incentive to issue is muted even if issuance spreads are attractive. Thus, it may not be so surprising that we do not find statistically significant evidence of an increase in issuance of TALF-eligible ABS relative to ineligible ABS.

Even with the Fed's prior experience in operating the TALF, the "time to market" (that is, the time between the announcement of the program and the first TALF subscription) was considerable (three months) due to the increased operational complexity of TALF 2.0. However, the Fed's focus on TALF transparency allowed TALF 2.0 to gain the confidence of market participants and played a part in the program's success in normalizing market functioning.

APPENDIX 1: LIST OF SECURITIES IN ABS SPREAD DATA

TALF-eligible securities are:

- Prime Auto AAA 3-Year
- CMBS 5-Year
- Card AAA 3-Year and 5-Year (Fixed and Floating Rates)
- Equipment AAA 3-Year
- CLO 4-5.5 Years
- Private Student Loan AAA 3-Year and 7-Year

The TALF-ineligible securities are:

- Federal Family Education Loan Program (FFELP) Securities
- Card BBB 5-Year (Fixed Rates)
- Prime Auto BBB 3-Year
- Subprime Auto AAA 2-Year and BBB 3-Year

APPENDIX 2: LIST OF SECURITIES IN ABS ISSUANCE DATA

TALF-eligible securities are:

- Floorplan
- Equipment
- Student Loan ABS
- Credit Card ABS
- Auto Loan / Lease ABS
- CDO (including CDO and CLO)
- CMBS Conduit

The TALF-ineligible securities are:

- Miscellaneous (Esoteric ABS)
- Commercial Real Estate CDO and CLO
- CMBS Single Asset Single Borrower (SASB)

NOTES

Acknowledgments: The authors thank Marco Cipriani, Rita Csejtey, Karen Pence, Scott Sherman, and an anonymous referee for helpful comments.

¹ For the initial TALF announcement, see <https://www.federalreserve.gov/newsevents/pressreleases/monetary20200323b.htm>. The New York Fed TALF page contains links to all materials, detailed reporting, and subsequent board announcements: <https://www.newyorkfed.org/markets/term-asset-backed-securities-loan-facility>.

² An SPV is a separate legal entity created by an organization, typically to carry out a special purpose. See <https://corporatefinanceinstitute.com/resources/knowledge/strategy/special-purpose-vehicle-spv/>.

³ For example, securitization funded around 45 percent of both credit card and auto loans in September 2008 (Covitz, Meisenzahl, and Pence 2021).

⁴ For the provisions of Section 13(3), see <https://www.federalreserve.gov/aboutthefed/section13.htm>.

⁵ For provisions of the CARES Act, see Public Law 116-136. <https://www.congress.gov/116/plaws/publ136/PLAW-116publ136.pdf>.

⁶ A U.S. business that owns eligible collateral may borrow from the TALF if it (a) is created or organized in the United States or under the laws of the United States, (b) has significant operations in and a majority of its employees based in the United States, and (c) maintains an account relationship with a TALF Agent. See the TALF FAQ: <https://www.newyorkfed.org/markets/term-asset-backed-securities-loan-facility/term-asset-backed-securities-loan-facility-faq>.

⁷ Additional details can be found in the TALF FAQ. <https://www.newyorkfed.org/markets/term-asset-backed-securities-loan-facility/term-asset-backed-securities-loan-facility-faq>.

⁸ See the section “What Did We Learn” for a comparison of TALF 1.0 and TALF 2.0. For information on TALF 1.0, see <https://www.newyorkfed.org/markets/talf>.

⁹ The survey results are reported on the Federal Reserve Board’s website. <https://www.federalreserve.gov/data/scoos.htm>.

¹⁰ There were twenty-two participating institutions in the Q1 2020 survey.

¹¹ For further details on the TALF expansion, see <https://www.federalreserve.gov/newsevents/pressreleases/files/monetary20200409a1.pdf>.

¹² For the list of Fed actions on April 9, see <https://www.federalreserve.gov/newsevents/pressreleases/monetary20200409a.htm>.

¹³ For a list of Fed announcements on March 23, 2020, see <https://www.federalreserve.gov/newsevents/pressreleases/monetary20200323b.htm>.

¹⁴ We define the “Dec. 31 Expiration” dummy variable to include both the week ending December 31, 2020, and the week ending January 7, 2021.

¹⁵ See Kristen Haunss, “CLO Issuance Falls 48 Percent as Rush of Loan Downgrades Threatens Investor Distributions,” *Yahoo! Finance*, April 17, 2020, <https://finance.yahoo.com/news/clo-issuance-falls-48-rush-135437340.html>.

¹⁶ Regarding shorter reinvestment terms for CLOs, see <https://www.fitchratings.com/research/structured-finance/short-reinvestment-terms-supporting-us-clo-issuance-19-06-2020>.

¹⁷ For further details, see <https://www.msci.com/www/blog-posts/covid-stimulus-helped/02297638613> and http://www.spglobal.com/_assets/documents/ratings/research/100048329.pdf.

¹⁸ See Ashcraft, Gârleanu, and Pedersen (2011) for an analysis of the 2008 version of TALF.

NOTES (CONTINUED)

¹⁹ It is important to note that spreads widened more substantially and for a longer duration in 2008 compared with 2020, creating the potential for a bigger reversal in spreads after TALF 1.0 was implemented.

²⁰ Other factors may have contributed to the different behavior of CLO spreads in the two TALF episodes. These include: (1) investor appetite for complex securitized products was low in 2009, as evidenced by the low issuance volume of CLOs in 2009 and 2010; and (2) the size of the CLO market was substantially larger in 2020, indicative of CLOs being recognized as a major securitization asset class—a factor that may have influenced market participant perception of eventual inclusion.

²¹ For an overview of the Fed’s actions, see Michael Fleming, Asani Sarkar, and Peter Van Tassel, “The COVID-19 Pandemic and the Fed’s Response,” Federal Reserve Bank of New York *Liberty Street Economics*, April 15, 2020, <https://libertystreeteconomics.newyorkfed.org/2020/04/the-covid-19-pandemic-and-the-feds-response/>.

REFERENCES

- Ashcraft, A., N. Gârleanu, and L. H. Pedersen. 2011. “Two Monetary Tools: Interest Rates and Haircuts.” *NBER MACROECONOMICS ANNUAL*, Volume 25. <https://www.journals.uchicago.edu/doi/full/10.1086/657530>.
- Campbell, S., D. Covitz, W. Nelson, and K. Pence. 2011. “Securitization Markets and Central Banking: An Evaluation of the Term Asset-Backed Securities Loan Facility.” *JOURNAL OF MONETARY ECONOMICS* 58 (no. 5): 518-31.
- Covitz, D. M., R. R. Meisenzahl, and K. M. Pence. 2021. “Incentives and Trade-offs in Designing a Crisis Liquidity Facility with Nonbank Counterparties: Lessons from the Term Asset-Backed Securities Loan Facility.” Federal Reserve Board, unpublished paper.

THE PAYCHECK PROTECTION PROGRAM LIQUIDITY FACILITY

Desi Volker

OVERVIEW

- The Federal Reserve established the Paycheck Protection Program Liquidity Facility (PPPLF) in April 2020 to boost lender participation in the Small Business Administration's Paycheck Protection Program (PPP), which offered small businesses forgivable government-guaranteed loans to keep workers paid and employed amid the COVID-19 outbreak.
- This article describes the features and goals of the PPP and the PPPLF, and analyzes the facility's loan take-up and its impact on lender participation in the PPP and PPP loan disbursements.
- The findings suggest that by supplying liquidity to smaller lenders such as community banks and fintechs, the PPPLF helped bolster the PPP's effectiveness by increasing loan origination to the smaller businesses served by these lenders, across wide geographic areas.

Starting in early spring of 2020, the COVID-19 outbreak caused unprecedented widespread disruptions to economic activity that had a significant impact on businesses and state and local municipalities, as well as individuals. To mitigate some of these disruptions and provide relief to entities affected by the economic fallout from the measures to contain COVID-19, Congress signed the Coronavirus Aid, Relief, and Economic Security Act (CARES Act) into law on March 27, 2020. Among other provisions, the CARES Act established funding for forgivable government-guaranteed loans to small businesses under the Small Business Administration's (SBA) Paycheck Protection Program (PPP).¹

The PPP was aimed at providing a lifeline to small businesses to help them maintain payroll and keep workers paid and employed. Small businesses could apply for loans through an extended list of lenders, which included then-current SBA-approved lenders and, over time, newly approved lenders such as banks, credit unions, financial technology firms (fintechs), and online marketplaces. The program went through several phases, characterized by new batches of funding, deadline extensions, and refinement and clarification of rules and guidelines. The SBA reimbursed

Desi Volker is a financial economist in the Federal Reserve Bank of New York's Research and Statistics Group. Email: desi.volker@ny.frb.org.

The views expressed in this article are those of the author and do not necessarily reflect the position of the Federal Reserve Bank of New York or the Federal Reserve System. To view the author's disclosure statement, visit https://www.newyorkfed.org/research/epr/2022/epr_2022_PPPLF_volker.

lenders with generous loan origination and processing fees; in addition, for larger approved lenders, the loans provided an attractive interest rate relative to the cost of funding. However, for some smaller lenders, including community banks and fintechs, these incentives were perceived to be insufficient to induce broad participation in the program. Balance-sheet constraints were an additional hindrance to lender participation.

To provide an impetus for program participation, as well as liquidity at attractive rates, the Federal Reserve, with the backing of the Secretary of the Treasury, established the Paycheck Protection Program Liquidity Facility (PPPLF) on April 8, 2020.² Pursuant to Section 13(3) of the Federal Reserve Act, the regional Federal Reserve Banks were authorized to extend nonrecourse credit to eligible financial institutions participating in the PPP, with PPP loans as collateral. While the facility's direct aim was to bolster the effectiveness of the PPP and thereby provide relief to small businesses affected by COVID-19, more generally it served a purpose similar to that of other 13(3) facilities in providing liquidity to credit markets, as per the Federal Reserve's role as lender of last resort when private liquidity becomes scarce. By extending much needed cheap liquidity to small PPP lenders, the PPPLF helped boost PPP loan origination across wide geographic areas and in underserved and underprivileged business communities, in line with the guidance in the CARES Act.

In this article, we lay out the background and main features of the PPPLF, discuss the intended aim of the facility, and analyze loan take-up, the facility's impact on lender participation in the PPP, and PPP loan disbursements.

1. THE PAYCHECK PROTECTION PROGRAM

The CARES Act was aimed at responding to the COVID-19 outbreak and addressing its economic impact. Among other provisions, the act extended relief to small businesses affected by COVID-19 by establishing funding for forgivable bridge loans and providing additional funding for grants and technical assistance. The PPP, a Section 7(a) loan program of the Small Business Act (15 U.S.C 636), was an important part of these efforts, aimed at providing a life-line to small businesses to help them maintain payroll, thereby keeping workers paid and employed during the crisis. Congress issued guidance to prioritize small businesses that operate in underserved and rural markets and/or that are controlled by veterans, members of the military, or individuals from socially or economically disadvantaged communities. Initially, \$349 billion was authorized in PPP funds for forgivable government-guaranteed loans to small businesses to cover their costs related to payroll (including salaries and benefits), as well as utility, mortgage, and rent payments.

The general features of the program were laid out in the CARES Act and detailed further in the interim final rule issued by the SBA in consultation with the Secretary of the Treasury. The first phase of the program was open from April 3 to June 30, 2020; however, available funds were quickly exhausted. Given the PPP's popularity and the continuing need to support small businesses as the pandemic persisted, lawmakers replenished the total available funds, refined rules and requirements, and extended the program until May 31, 2021. As of that date, 11,823,594 loans were approved for a total of nearly \$800 billion.

1.1 Eligible Borrowers

To be eligible for PPP loans, businesses needed to have 500 or fewer employees³ and be adversely affected by COVID-19 and the measures enacted to contain its spread. Businesses had to be operational on February 15, 2020, in order to be eligible and must have had employees for whom they paid salaries and payroll taxes, or hired independent contractors.⁴ The same loan terms applied to all applicants, and full principal loan amounts qualified for forgiveness as long as employee and compensation levels were maintained (with some caveats). Businesses had to submit a PPP loan application to an SBA-approved lender, along with the documentation necessary to establish eligibility, including payroll records and tax filings or income and expenses from a sole proprietorship.⁵ As part of the application, the borrower had to provide a good-faith certification that the current economic uncertainty made the loan necessary to support ongoing operations and that the loan would be used to retain workers and maintain payroll or to make mortgage, lease, and utility payments. No pledge of collateral and no personal guarantee were required. Loans were initially capped at one per applicant; however, a second draw was later allowed. Loan applications were processed in the order in which they were received by the SBA, not by when the applications were submitted to lenders, an approach that, especially in the first round of the program, had significant implications for loan allocations.

1.2 Terms of Credit

The maximum PPP loan amount for which businesses could apply was set to the lesser of \$10 million or an amount equal to 2.5 times the average monthly payroll costs from the previous year.⁶ The interest rate on the loan was set at a fixed rate of 1 percent, in order to provide low-cost funding for borrowers and at the same time offer an attractive interest rate for lenders relative to the cost of funding for comparable maturities.⁷ Borrowers were not required to pay PPP loan fees to either the lender or the SBA, and interest payments were deferred initially for six months (then extended to ten months) after the covered period. The loans had a two-year maturity after approval, extended to five years for loans issued after June 5, 2020. Prepayment was possible, with no prepayment fees or penalties. For loans with a remaining balance after a reduction based on loan forgiveness, the remaining balance was guaranteed by the SBA and forgiven loan amounts were tax free for federal tax purposes.

An important feature of the PPP was loan forgiveness. To qualify for forgiveness, borrowers had to show that they had not decreased their full-time employee head count or reduced salaries and wages by more than 25 percent (later increased to 40 percent) for any employee who made less than \$100,000 in 2019. They needed to maintain payroll levels and employee count for the covered period (between eight and twenty-four weeks after the loan was originated). Firms that had laid off employees or reduced salaries were given time to restore their full-time employment and salary levels to qualify for loan forgiveness. The amount eligible for loan forgiveness was conditional on the total loan amount and its use (that is, the proportion of the loan used to finance eligible qualifying expenses, such as payroll, salaries, mortgage/rent payments, and utilities as detailed above). At least 75 percent (lowered eventually to 60 percent) of the loan proceeds had to be used for payroll expenses for the loan's entire principal to be forgiven. If a lesser amount was dedicated to payroll, the forgivable amount would be reduced proportionally.

1.3 Eligible Lenders

Normally, SBA-guaranteed loans are issued by an existing network of banks that are SBA-approved lenders; however, for the purposes of the PPP, the list of lenders with authority to make covered loans was extended to include additional lenders determined by the SBA and the Secretary of the Treasury to have the necessary qualifications to process, close, disburse, and service SBA-guaranteed loans. Many banks, credit unions, fintech lenders, and online lending marketplaces that were not already SBA-approved lenders but were willing to participate in the program were encouraged to apply to become PPP lenders. To provide expeditious relief to small businesses, the SBA gave delegated authority to all approved PPP lenders and streamlined the requirements of the regular Section 7(a) loan programs. Existing SBA loan programs required lenders to assess the borrower's creditworthiness and required borrowers to post collateral and issue a personal guarantee for the loan, as well as a certification that the borrower couldn't secure credit elsewhere. These requirements and other regular 7(a) lending criteria were waived for PPP loans; lenders could rely instead on certifications of the borrower in order to determine borrower eligibility, as well as eligibility of the loan amount, the use of loan proceeds, and the forgivable amount. Lenders had to comply with the applicable lender obligations set forth in the SBA's interim final rule but were not held liable for borrowers' failure to comply with program criteria or for any misrepresentations made by borrowers in connection with a request for PPP loan forgiveness.

1.4 Incentives for Lenders

The SBA reimbursed authorized lenders for originating and processing covered loans at a rate based on the balance of the financing outstanding for the disbursement of the loans,⁸ a rate that ranged from 1 percent to 5 percent. In particular, lenders originating PPP loans with total loans outstanding of up to \$350,000 would receive a fee of 5 percent of the principal; lenders with PPP loans outstanding from \$350,000 to \$2 million would receive a fee of 3 percent of the principal; and lenders with PPP loans outstanding above \$2 million would receive a fee of 1 percent of the loan principal.

By originating and holding PPP loans on their balance sheets, banks could potentially be exposed to increased regulatory capital requirements.⁹ While the CARES Act specified that PPP-covered loans originated by a banking organization would carry a zero percent risk weight and therefore would not affect the bank's risk-based capital requirements, PPP loans held on a bank's balance sheet could potentially affect the bank's leverage-based regulatory capital requirements and its liquidity coverage ratios (LCR). To alleviate this issue and give lenders an incentive to participate, the pertinent regulatory agencies—the Federal Reserve, the Office of the Comptroller of the Currency (OCC), and the Federal Deposit Insurance Corporation (FDIC)—further specified that PPP loans and the lines of credit extended under the PPPLF would be exempt from inclusion in calculations of all regulatory capital requirements of banks and bank holding companies, including risk-based and leverage-based capital and for LCR purposes.

The federal agencies that regulate financial institutions generally require institutions to classify certain loan modifications as troubled debt restructurings (TDRs). The CARES Act and the

interim final rule issued by the SBA, in consultation with the Secretary of the Treasury, allowed financial institutions to suspend such requirements on PPP loan modifications. To provide further incentives for lenders to participate, covered PPP loans were eligible to be sold in the secondary market. No fees would be collected by the SBA for any guarantee sold into the secondary market and the loans would continue to receive a risk weight of zero percent. Insured depository institutions and credit unions that would restructure PPP-covered loans were given temporary relief from TDR accounting standards and disclosures for the purposes of compliance with FDIC requirements.

1.5 Program Implementation Hurdles and Overall Success

Since the volume of applications for PPP loans was a multiple of the regular volume for SBA loans, a variety of technical implementation issues arose in the program's initial phase. In the first few days of the PPP, the large volume of applications overwhelmed the SBA's application system and its computers crashed,¹⁰ raising the need to create a backup system. The internal processes of small banks and other approved small lenders faced similar constraints in dealing with the unprecedented volume of applications. Even larger banks such as Wells Fargo and Bank of America ran into capacity problems.¹¹ Some lenders cited uncertainty about the nature of accountability in borrower screening as another factor that delayed the processing of applications. In the initial phase of the PPP, many of the details about program implementation remained somewhat unclear.

Overall, the PPP provided attractive incentives for both borrowers and lenders to participate in the program. PPP loans had very generous terms compared to existing SBA-backed loans, with an interest rate substantially lower than that under regular 7(a) loan programs (which are commonly used in lender-of-last-resort situations), requiring no SBA and lender fees, and deferring interest and principal payments for at least six months. At the same time, from the lenders' perspective, the interest rate on the loans and the generous origination and processing fees were quite attractive in an environment of very low interest rates. The PPP provided significant flexibility along many dimensions: Because of the reduced eligibility requirements, it had a broad base of potential borrowers; it did not discriminate against applicants who had been denied credit previously; and no pledges of collateral or personal guarantees were needed. Furthermore, the program significantly extended the base of potential lenders beyond existing SBA-approved lenders to include small banks, fintechs, and online marketplaces.

Critical views regarding the program's design and effectiveness were raised along a few dimensions, including whether the program was sufficiently funded to meet the demand for loans, whether credit allocation was in line with the intended aim of the program, and whether the program had the intended effects on employment. While the allocated funds in the first round of the PPP were clearly insufficient, they were replenished in the subsequent rounds. Liu and Volker (2020a) and Granja et al. (2020) show that the geographical distribution of PPP loans in the first round of funding did not reflect the severity of the economic impact of the pandemic. This uneven distribution was later mitigated with the subsequent rounds of funding. Liu and Volker (2020a) point to the importance of relationship lending for the allocation of PPP loans in the first round of the program and to the significant role played by community banks. James, Lu, and Son (2021) confirm these findings and suggest that the focus on relationship lending allowed

community banks to respond faster to PPP loan requests than larger banks and to lend more than larger banks relative to their assets. Li and Strahan (2020) also find that bank relationships helped firms access PPP lending. In terms of funding allocation, Barrios et al. (2020) suggest that funds from the PPP have been broadly allocated according to the distribution of eligible payrolls. Granja et al. (2020) suggest that the employment effects of the PPP were small, while Autor et al. (2020) and Barraza, Rossi, and Yeager (2020) find that the program was somewhat successful in meeting its objective of preserving jobs during the pandemic, and that it had statistically and economically significant effects on employment.

2. THE PAYCHECK PROTECTION PROGRAM LIQUIDITY FACILITY (PPPLF)

In order to provide quick relief to small businesses across all affected geographic areas, the SBA encouraged non-SBA-approved lenders to apply to participate in the PPP, pledging an expeditious approval process should applicants be deemed to possess the necessary qualifications to issue SBA-guaranteed loans. There was some initial uncertainty about the criteria that potential lenders would have to meet, raising concerns about the breadth of participation among small lenders. Furthermore, some smaller lenders, community banks, and fintechs reported that given their higher funding costs relative to those of larger banks, the loan terms were not attractive enough to encourage broad participation. Another issue affecting small lenders' incentives to participate in the PPP was their balance-sheet capacity. For larger regulated bank holding companies, a disincentive was the potential effect that holding PPP loans on balance sheet would have on their regulatory capital.

To address funding cost issues, improve liquidity, and create the right incentives for the broadest possible base of PPP-participating lenders, the Federal Reserve, with the backing of the Secretary of the Treasury, announced on April 6, 2020, that it would establish a new Section 13(3) facility to facilitate lending to small businesses through the PPP. Section 13(3) of the Federal Reserve Act allows the Federal Reserve, with prior approval of the Secretary of the Treasury, to extend lending in unusual and exigent circumstances to individuals, partnerships, and corporations through programs with broad-based eligibility. The new facility, the Paycheck Protection Program Liquidity Facility, was aimed at bolstering the PPP by supplying liquidity to financial institutions participating in the program in the form of term financing on a nonrecourse basis backed by the SBA's PPP loans. Liu and Volker (2020b) provide an overview of the intended aim of the facility. Ultimately, the new facility would serve a purpose broadly similar to that of other Section 13(3) facilities—that is, to provide liquidity to credit markets and balance-sheet relief to financial institutions with the aim of supporting economic activity, in line with both the Federal Reserve's role as lender of last resort and its monetary policy mandate. While other emergency facilities set up by the Federal Reserve in response to COVID-19 potentially exposed taxpayers to a small risk of losses due to potential borrowers' default or a fall in the market value of the securities, the full principal of PPPLF credit extensions was backed by PPP loans as collateral, loans that in turn have a full SBA guarantee on their principal value. This lack of credit-risk exposure allowed the Federal Reserve to impose no PPPLF participation fees on borrowers and to charge a low interest rate, thereby encouraging relatively high take-up rates and acting as a significant boost to the PPP.

2.1 Eligible Borrowing Institutions

On April 7, 2020, the Federal Reserve Board, with the approval of the Secretary of the Treasury, authorized each of the regional Federal Reserve Banks to participate in the PPPLF, pursuant to Section 13(3) of the Federal Reserve Act. Initially, the Board announced that eligible borrowers under the PPPLF would be limited to depository institutions originating PPP loans, with a plan to quickly expand eligibility to all other nondepository institutions participating in the PPP. On April 30, 2020, access to the PPPLF was extended to all PPP lenders that had a corresponding banking relationship with a depository institution with a master account at the Federal Reserve. These included banks, credit unions, community development financial institutions (CDFIs),¹² members of the Farm Credit System, small business lending companies, and financial technology firms. Eligible PPPLF borrowers that were depository institutions or credit unions would participate in the facility through the regional Federal Reserve Bank in whose District they were located. CDFIs would apply for a PPPLF credit line extension through the Federal Reserve Bank of Cleveland; members of the Farm Credit System and small business lending companies that were not depository institutions or credit unions would apply through the Federal Reserve Bank of Minneapolis; and all other eligible borrowers would apply through the Federal Reserve Bank of San Francisco. The initial announcement stated that the facility would be operational for extending new lines of credit until September 30, 2020. However, because the PPP was extended beyond the initial phases, the PPPLF termination date for new lines of credit was also extended and was ultimately set at July 30, 2021.

2.2 Terms of Credit

Financial institutions participating in the PPP could finance themselves for issuing PPP loans through the PPPLF, at attractive low rates of 35 basis points (65 basis points below the 1 percent fixed interest on PPP loans) and with no facility participation fees. Only SBA-guaranteed PPP loans would be eligible to serve as collateral for borrowing under the PPPLF, with the principal amount of an extension of credit equal to the principal amount of the PPP loan pledged as collateral.¹³ There was no cap on the amount of credit that could be extended to eligible financial institutions, except that the principal could not exceed that of the PPP loans pledged as collateral. Eligible borrowers could pledge PPP loans that they had originated or purchased in the secondary market. Eligible borrowers pledging PPP loans purchased on the secondary market needed to document that they were the beneficiary institution of the SBA guarantee for the loan in order to get a PPPLF credit extension backed by the purchased PPP loans. Extensions of credit under the facility would be made without recourse to the borrower, given that the PPP loans pledged as collateral are fully guaranteed by the SBA. The maturity date of an extension of credit under the facility was set to equal the maturity date of the PPP loan pledged to secure the extension of credit. It would be accelerated if the underlying PPP loan went into default, and the eligible PPPLF borrower would sell the PPP loan to the SBA to exercise the SBA guarantee. Similarly, the maturity date of the extension of credit would be accelerated to the extent of any loan forgiveness reimbursement received by the PPPLF borrower from the SBA. The PPPLF credit line would be extinguished should a borrower sell its PPP loans in the secondary market.

2.3 Impact of Loans on Institutions' Balance Sheets and Their Regulatory Capital

One source of concern about lenders' ability to participate in the PPP was balance-sheet capacity and the effect of loans on regulatory requirements. Capital rules imposed by the federal regulatory agencies (the Federal Reserve, the OCC, and the FDIC) require supervised banking organizations to comply with risk-based capital requirements (based on risk-weighted assets) and leverage capital requirements (based on average total assets or total leverage exposure). By virtue of originating PPP loans and holding them on their balance sheets, banks participating in the PPPLF could potentially be subject to increased regulatory capital requirements. Since PPP loans pledged at the PPPLF do not expose the bank pledging them to any credit or market risk (given the nonrecourse nature of the extension of credit under the PPPLF), the regulatory agencies deemed it appropriate to exclude the effects of PPP-covered loans from banks' regulatory capital. In particular, banks could exclude exposures pledged as collateral to the PPPLF from their total leverage exposure as well as from their average total consolidated assets, their advanced approaches total risk-weighted assets, and their standardized total risk-weighted assets. Similarly, PPP loans would be excluded from calculations pertinent to the community bank leverage ratio. The interim final rule issued by the Federal Reserve in conjunction with the OCC and the FDIC codified these exemptions by specifying that banks originating PPP loans relying on financing under the PPPLF would be exempt from the regulatory capital requirements applied to bank holding companies.

These exemptions, combined with the attractive interest rate, loan origination fees, and the liquidity provided under the PPPL facility, helped give lenders an incentive to participate in the PPP. The additional liquidity PPP lenders obtained through the PPPLF helped increase their capacity to originate additional PPP loans and satisfy the large demand from small businesses for such loans. The lifeline to small businesses that the PPP provided and the boost to the PPP through the PPPLF liquidity injections helped to limit small business failures and to keep workers employed and the economy going.

2.4 Community Development Financial Institutions (CDFIs)

One group of PPP lenders that was strongly encouraged to participate in the PPP and that particularly benefited from access to the PPPLF were community development financial institutions. CDFIs are mission-oriented lenders certified by the Treasury Department that focus on financing small businesses and individuals in low economic opportunity areas, and communities with minority or underprivileged backgrounds. The cost of funding for CDFIs is generally higher than that for traditional banks, which can access the Federal Reserve's discount window and borrow at reasonably low rates in credit markets in the current low-rate environment. Around half of the existing CDFIs are depository community banks, while the rest are loan funds and other nondepository institutions.

CDFIs that are depository institutions and have a master account at a Federal Reserve Bank have access to the Federal Reserve's discount window, while loan funds do not. For loan funds, access to the PPPLF constituted a major incentive to participate in the PPP, by

providing a cheap funding source to finance the origination of PPP loans. Access to the PPPLF was also very useful for depository CDFIs that may not have been in “generally sound financial condition” and therefore did not qualify for the discount window’s primary credit. The rate for the discount window’s secondary credit, at 50 basis points plus the primary credit rate, is significantly higher than the rate for extensions of credit under the PPPLF.

Initially, CDFI loan funds faced hurdles in accessing credit through the PPPLF because of the need to have a corresponding banking relationship with a depository institution with a master account at the Federal Reserve, due to the latter’s operational complexities and capacity limits for approvals, as well as the perceived risk. In the early summer of 2020 and during the second round of the PPP, this issue was significantly mitigated as many depository institutions agreed to establish correspondent banking relationships with loan funds and other nondepository institutions participating in the program (Eggleston 2021). CDFIs’ broad participation in the PPP was strongly encouraged, given their mission-oriented nature in serving underprivileged communities, which typically have a harder time accessing credit through traditional financial institutions. The CARES Act specifically instructed the SBA to issue guidance to lenders to prioritize small businesses in underserved and rural markets, and those controlled by veterans, members of the military, and individuals in socially and economically disadvantaged communities.

2.5 Fintechs

Media coverage reported that as soon as the CARES Act was announced, and especially once the PPPLF was announced with its attractive incentives for small lenders, several fintech companies lobbied the Treasury Department to allow them to participate in the PPP.¹⁴ On April 9, 2020, the Treasury announced that it would allow fintechs to apply to become PPP lenders. In the first few weeks of the PPP’s launch, the SBA approved the applications of a few fintech companies, including PayPal, Intuit, and Square. PayPal announced that it received approval on April 10, and as of the following Monday, it had already received applications and had approved PPP loans. Similarly, on April 13, Square Capital and Intuit’s QuickBooks Capital announced they had received approval to become PPP lenders. QuickBooks Capital launched a new, free website, “Intuit Aid Assist,” to help small businesses and self-employed individuals assess their eligibility to borrow under the PPP as well as their eligible loan amount. Square Capital announced that it would operate in partnership with Celtic Bank. In the later days of phase one of the PPP and in phase two, several other fintech lenders were approved and disbursed loans, some in collaboration with established traditional bank holding companies. Expansion of the pool of approved PPP lenders to fintech companies sped up and simplified the loan application and disbursement process for many small businesses, given the fintechs’ broad geographic coverage, their automated application process, and their relatively more rapid and flexible innovation capabilities compared to the more bureaucratic traditional banks. The presence of fintech lenders may also have helped expand the pool of potential applicants in the first phase of the PPP, since traditional bank lenders had prioritized borrowers with existing banking relationships because doing so involved a lesser need for extensive screening.

2.6 The Program's Effectiveness

Overall, there is evidence that the PPPLF was successful in bolstering the effectiveness of the Paycheck Protection Program. The liquidity provision through the PPPLF enhanced the ability of many small lenders to originate PPP loans, and PPPLF take-up increased significantly in the second half of 2020 and early 2021. Arguably, the introduction of the PPPLF mitigated many of the initial setbacks of the PPP, when small businesses' demand for PPP loans was significantly higher than lenders' capacity to originate and process loans and when the insufficient PPP funds in place were being rapidly exhausted. For example, Anbil, Carlson, and Styczynski (2021), using an instrumental variables approach, find that commercial banks that accessed PPPLF funding originated more than twice as many PPP loans relative to their total assets than banks that did not access PPPLF funding. Lopez and Spiegel (2021) find that both the PPP and the PPPLF had a positive effect on the growth in small business and farm lending in the first half of 2020, with the PPPLF having a significant impact on increasing lending of small and medium-sized banks. The results presented in the next section are in line with these findings, with smaller depository institutions and nondepository institutions relying more on PPPLF funding to finance PPP loan origination.

3. PPPLF TAKE-UP

As required by Section 13(3) of the Federal Reserve Act, the Federal Reserve has each week publicly disclosed PPPLF credit extensions on a nationwide aggregated basis. In this section, we examine the distribution of PPPLF loans over time by PPPLF borrower/PPP lender size and industry.

3.1 Aggregate Lending

We begin with the total outstanding balance of PPPLF loans over time, shown in Chart 1. We can see that the aggregate balance jumped sharply in the first few months after the PPPLF became operational; it then gradually declined before rebounding again. The aggregate balance of PPPLF credit extensions can decline for the following reasons: (1) forgiveness of the underlying PPP loans pledged as collateral by the borrowing financial institution; (2) repayment of the underlying PPP loans; or (3) sale by the borrowing institution of the underlying PPP loans in the secondary market or to the SBA to realize the full principal guarantee. As small businesses that received PPP loans apply for and are granted forgiveness, the PPP lenders with PPPLF credit extensions backed by those loans need to draw down the PPPLF balance accordingly, because the collateral needs to match the disbursement. For a similar reason, the PPPLF balance declines when the underlying PPP loans pledged as collateral are repaid by small businesses.

Chart 2 shows the total cumulative balance of PPPLF loans disbursed over time. We can see that the balance gradually increases over the life of the program, with steeper climbs around the early months when the PPPLF became operational in the spring of 2020 and at the

CHART 1
PPPLF Aggregate Loans Outstanding

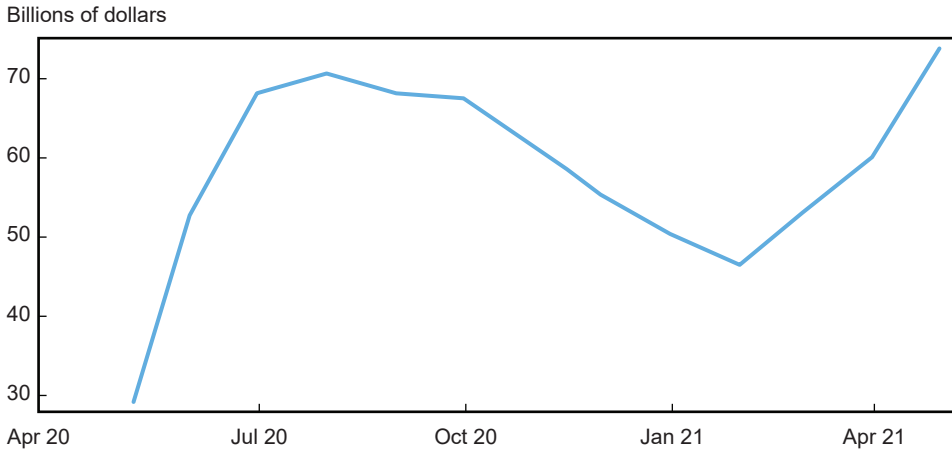

Sources: PPPLF transaction-specific disclosures from the Board of Governors of the Federal Reserve System; authors' calculations.

Note: The chart shows the total outstanding amount of active PPPLF loans from each monthly report for the PPPLF.

CHART 2
Aggregate Cumulative Origination of PPPLF Loans

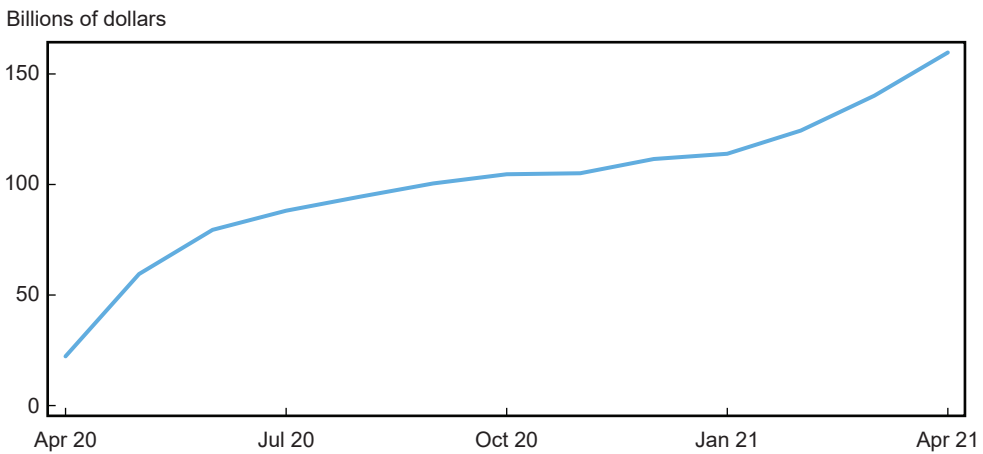

Sources: PPPLF transaction-specific disclosures from the Board of Governors of the Federal Reserve System; authors' calculations.

Note: The chart shows the total cumulative amount of PPPLF loans originated over time.

beginning of 2021. The later jump in the PPPLF can be explained by a rule in the Economic Aid Act, passed on December 27, 2020. The rule allowed both first-draw loans for small businesses that did not borrow in the first and second rounds of the PPP and second-draw loans for those that had existing PPP loans and applied for new loans due to continuing exigence. The extension of eligibility to second-draw loans stimulated another wave of PPP lending, followed by PPPLF applications for credit extensions by PPP lenders.

3.2 PPPLF Loan Distribution by PPPLF Borrower/PPP Lender Category

To understand the distribution of PPPLF credit lines by borrowing financial institutions, Charts 3 and 4 break down outstanding balance and cumulative origination by borrower type.

We determine PPPLF borrower/PPP lender type by merging PPPLF data with RSSD attributes and bank asset sizes (based on RSSD ID or ABA number)¹⁵ as per the December 2020 disclosure summary of the Federal Financial Institutions Examination Council's (FFIEC) Central Data Repository Public Data Distribution website, which contains call reports and uniform bank performance reports for most FDIC-insured institutions.

We classify regional banks (including national banks) as participating institutions with more than \$10 billion in total assets, community banks (including CDFIs that are depository institutions) as those having less than \$10 billion in assets, and the remaining institutions for which assets and attributes are not available based on the FFIEC repository as nondepository institutions. All PPPLF-participating financial institutions are classified into one of the three categories.

From Charts 3 and 4, we can see that at the beginning of the PPPLF, increases in the balance were mainly driven by national, regional, and community banks. The second surge in the PPPLF balance in early 2021 largely came from nondepository institutions.

To shed more light on the distribution of PPPLF loans by PPPLF borrower/PPP lender category relative to PPP loan originations, we merged the above data (PPPLF disclosures, RSSD attributes, and asset size from the FFIEC reports) with the PPP data disclosed by the SBA. The main difficulty in merging the data is that the SBA's PPP disclosures do not provide the ABA number or RSSD ID of the lending financial institutions. Participating institutions originating PPP loans are instead identified in the data based on their unique name and the city and state in which they are located. While the matching is not perfect, we follow a detailed data-cleaning process to match the reported names and locations with the information available from the PPPLF disclosures, and we manually confirm that the maximum number of lenders is matched across data sets.

Next, we study reliance on the PPPLF by institution type. Chart 5 illustrates cumulative PPPLF credit lines by institutional category following the classification delineated above. Community banks and CDFIs that are depository institutions borrowed the most from the PPPLF, followed by nondepository institutions. National and regional banks borrowed the least.

Chart 6 shows the total PPP distributed loan amounts by lender type, for the matched sample with PPPLF borrowing institutions. Since not all PPP lenders applied for PPPLF

CHART 3
PPPLF Loans Outstanding by PPPLF Borrower

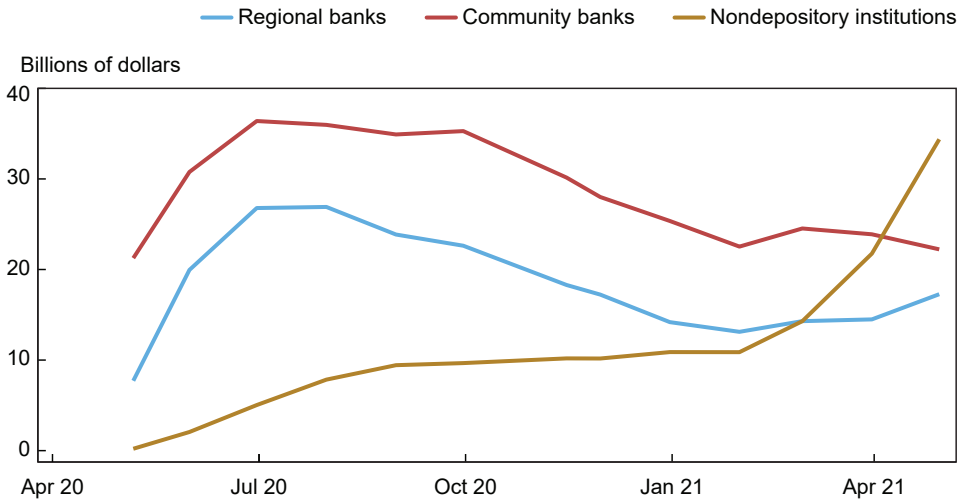

Sources: PPPLF transaction-specific disclosures from the Board of Governors of the Federal Reserve System; institution characteristics from the Federal Financial Institutions Examination Council's (FFIEC) Central Data Repository; authors' calculations.

Note: The chart shows the total outstanding amount of active PPPLF loans, broken down by PPPLF borrower.

CHART 4
Cumulative PPPLF Loan Origination by PPPLF Borrower

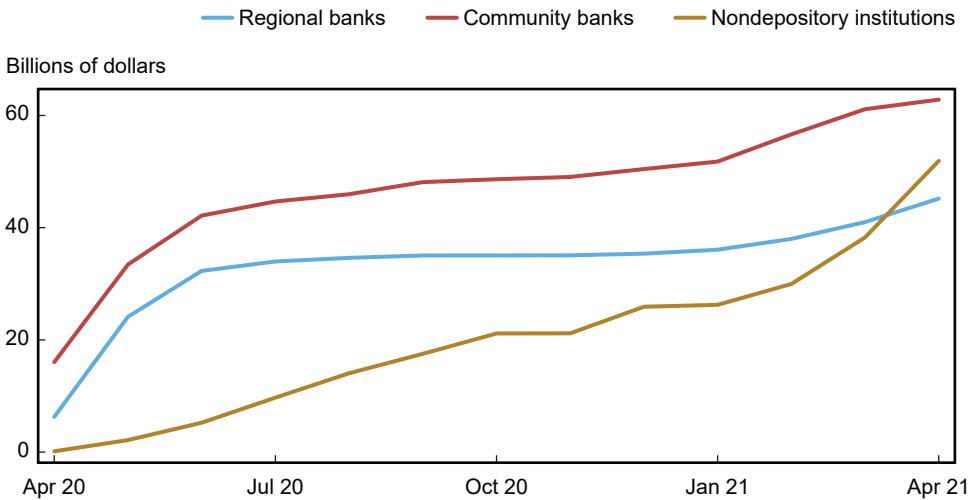

Sources: PPPLF transaction-specific disclosures from the Board of Governors of the Federal Reserve System; institution characteristics from the Federal Financial Institutions Examination Council's (FFIEC) Central Data Repository; authors' calculations.

Note: The chart shows the total cumulative amount of PPPLF loans originated over time, broken down by PPPLF borrower.

CHART 5
Total PPPLF Borrowed by Institution Type

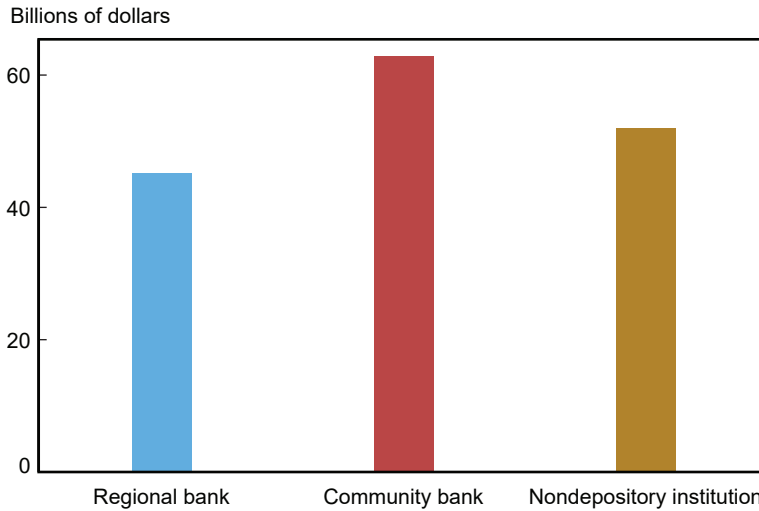

Sources: PPPLF transaction-specific disclosures from the Board of Governors of the Federal Reserve System; institution characteristics from the Federal Financial Institutions Examination Council's (FFIEC) Central Data Repository; authors' calculations.

Note: The chart shows the cumulative PPPLF amount borrowed by institution type.

CHART 6
Total Dollar Amount of PPP Loans Disbursed by PPP Lender

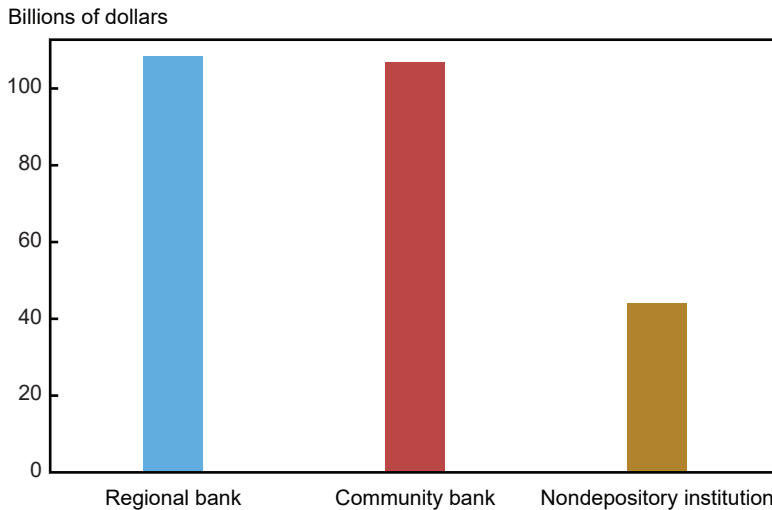

Sources: PPP reports from the U.S. Small Business Administration; PPPLF transaction-specific disclosures from the Board of Governors of the Federal Reserve System; institution characteristics from the Federal Financial Institutions Examination Council's (FFIEC) Central Data Repository; authors' calculations.

Note: The chart shows total PPP loans originated by each lender type for the matched sample of PPP lenders with PPPLF borrowers.

credit lines, the total PPP loan amounts shown in the chart are only a fraction of the entire PPP loan disbursements¹⁶. The limited coverage may also be due (although to a lesser extent) to the inherent issues with matching the data, given that the reported classifications of PPP lenders and PPPLF borrowers in the data disclosures are not perfectly aligned.

The matched data suggest that regional and national banks, as well as community banks (including CDFIs that are depository institutions), were the largest PPP loan originators, lending at similar levels in terms of dollar amount among the matched PPPLF borrower/PPP lender group. Nondepository institutions, on the other hand, originated less than half the dollar amount of PPP loans originated by regional and community banks as per our classification.

This may be the case for several reasons. First, nondepository institutions are more likely than depository institutions to lend to the smallest of small businesses, since larger and more established small businesses are more likely than smaller ones to have existing banking relationships. The maximum principal dollar amount of PPP loans is based on payroll numbers (over a representative month in the previous year); therefore, smaller businesses can apply for smaller loans relative to larger businesses with higher payroll numbers. Second, nondepository institutions had a slower start in participating in both the PPP and the PPPLF—the PPP because of the requirement to be an SBA-approved lender, and the PPPLF because of the delayed eligibility and the need to have a correspondent banking relationship with a depository institution with a master account at the Federal Reserve. Third, again the limitations inherent in the data matching and classification given the data constraints in the disclosures imply that some misclassification of institutions or matched PPP lender/PPPLF borrower pair cannot be ruled out.

Looking at this issue from a different angle, Chart 7 shows the total PPP distributed loan dollar amounts for PPP lenders with PPPLF credit lines compared with those that relied on other funding sources to finance PPP loan origination.

As we can see, PPP lenders that borrowed from the PPPLF to finance PPP loan originations issued a significantly smaller PPP loan dollar amount. Since PPP loans are proportional to the small businesses' payroll numbers, the dollar amount of PPP loans originated depends on the average size of the small businesses served by the PPP lender. A lender could originate many PPP loans and still have a relatively low total dollar amount of PPP loans outstanding depending on its PPP clientele base. This is confirmed by Charts 8 and 9. Chart 8 shows the total number of PPP loans originated by each lender category for the matched PPP lender/PPPLF borrower sample. Nondepository institutions originated a disproportionately large number of loans relative to the total disbursed dollar amount. Chart 9 shows total PPP loans disbursed by PPP lenders that received PPPLF credit extensions and those that did not. The difference in the number of PPP loans disbursed by PPPLF participating and nonparticipating institutions is a lot smaller than that based on dollar amount disbursed. Taken together, these results are in line with the conjecture that smaller PPP lenders and nondepository institutions are more likely to attract small businesses at the lower end of the size scale, which have fewer employees and lower payroll costs.

Chart 10 adds to these findings by showing the ratio of the PPPLF credit line balance to the dollar amount of PPP loans extended for each institution type in the matched PPPLF

CHART 7
Total PPP Loan Dollar Amount Disbursed

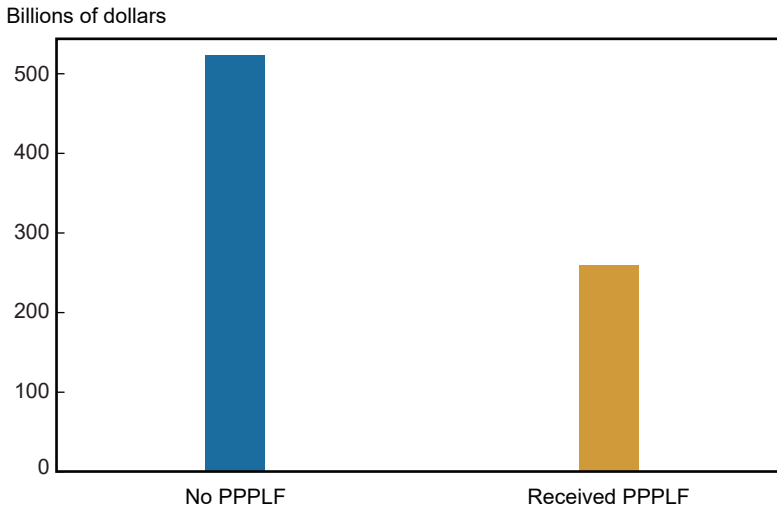

Sources: PPP reports from the U.S. Small Business Administration; PPPLF transaction-specific disclosures from the Board of Governors of the Federal Reserve System; institution characteristics from the Federal Financial Institutions Examination Council's (FFIEC) Central Data Repository; authors' calculations.

Note: The chart shows the total dollar amount of PPP loans disbursed by PPP lenders that received PPPLF credit extensions and those that did not.

CHART 8
Total Number of PPP Loans Disbursed by Lender Type

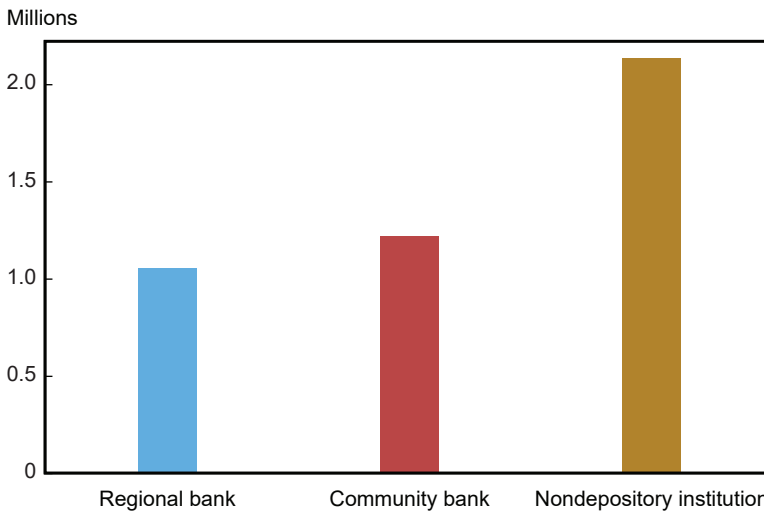

Sources: PPP reports from the U.S. Small Business Administration; PPPLF transaction-specific disclosures from the Board of Governors of the Federal Reserve System; institution characteristics from the Federal Financial Institutions Examination Council's (FFIEC) Central Data Repository; authors' calculations.

Note: The chart shows total PPP loans originated by each lender type for the matched sample of PPP lenders with PPPLF borrowers.

CHART 9

Total Number of PPP Loans Disbursed by PPPLF Participation Status

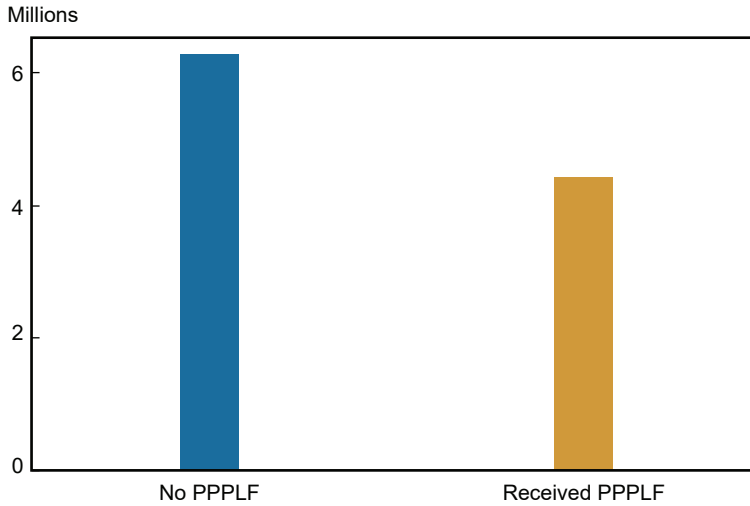

Sources: PPP reports from the U.S. Small Business Administration; PPPLF transaction-specific disclosures from the Board of Governors of the Federal Reserve System; institution characteristics from the Federal Financial Institutions Examination Council’s (FFIEC) Central Data Repository; authors’ calculations.

Note: The chart shows total PPP loans disbursed by PPP lenders that received PPPLF credit extensions and those that did not.

CHART 10

Fraction of PPP Loans Funded with PPPLF Borrowing

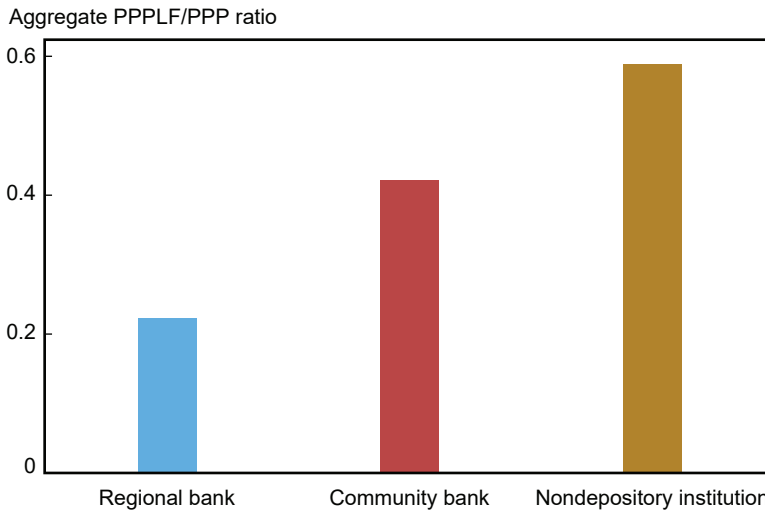

Sources: PPP reports from the U.S. Small Business Administration; PPPLF transaction-specific disclosures from the Board of Governors of the Federal Reserve System; institution characteristics from the Federal Financial Institutions Examination Council’s (FFIEC) Central Data Repository; authors’ calculations.

Note: The chart shows the fraction of PPP loans originated that were funded by PPPLF borrowing, broken down by lender type.

borrower/PPP lender sample. We can see that reliance on PPPLF borrowing to finance PPP loan originations declines with the asset size of the financial institution. National and regional banks (with more than \$10 billion in assets) rely the least on the PPPLF to finance PPP loans, with about 20 percent of the PPP loans financed by liquidity obtained through the PPPLF.

Community banks and nondepository institutions, on the other hand, relied more heavily on PPPLF financing, with about 40 percent and 60 percent, respectively, of their PPP loan originations funded through the PPPLF. One explanation for the lower use of the PPPLF by national and regional banks is that during the course of the pandemic, banks saw a large inflow of deposits from both consumers and corporate clients, providing an alternative funding source. This is in line with the pattern of PPPLF usage seen in Chart 5.

Erel and Liebersohn (2020) find that fintechs were disproportionately used in zip codes with fewer bank branches, lower incomes, and a larger minority share of the population, as well as in industries with little *ex ante* small business lending, suggesting that fintechs expanded the overall supply of PPP lending rather than substituting for traditional banks. Our results suggest that nondepository institutions (which include fintechs) took disproportionate advantage of the PPPLF to fund PPP loans and were likely to have served smaller businesses. Taken together with the evidence in Erel and Liebersohn (2020), our results indicate that the PPPLF played an important role in expanding the supply of credit to PPP lenders, allowing the origination of more PPP loans in underserved areas.

3.3 Geographical Distribution of Loans for Community Banks

The ratio of the cumulative dollar amount of PPPLF borrowing to the cumulative dollar amount of PPP loans originated by community banks by state is shown in Exhibit 1. Community banks here are defined as depository financial institutions with less than \$10 billion in total assets, including CDFIs that are depository institutions. While the geographical distribution of PPPLF borrowing by community banks for PPP loan origination is fairly equal across states, community banks located in the Great Plains, the South, and the Northeast seem to have borrowed relatively more from the PPPLF to finance PPP loan origination.

3.4 Loan Distribution by Industry

In what follows, we look at the breakdown by industry of the small businesses that received PPP loans, for those loans originated by PPP lenders that received PPPLF funding and those that did not receive PPPLF funding. To do this, we first calculate the cumulative PPP loans received by small businesses in a given industry (based on NAICS codes) that were originated by each type of financial institution (using our three-category classification for lender type based on total assets). We then link these to the matched PPPLF borrowing/PPP lending financial institutions to obtain the industry breakdown of PPP loans originated for financial institutions that received PPPLF funding.

EXHIBIT 1

PPPLF Borrowing/PPP Lending Ratio for Community Banks by State

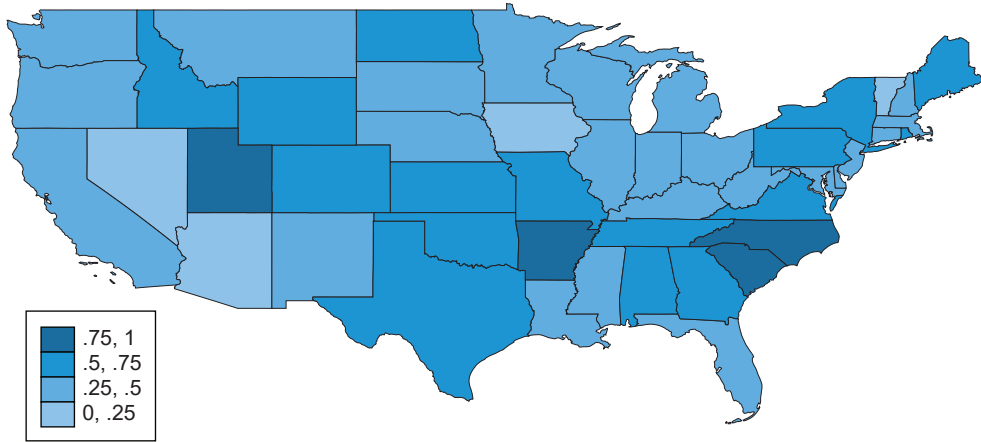

Sources: PPP reports from the U.S. Small Business Administration; PPPLF transaction-specific disclosures from the Board of Governors of the Federal Reserve System; institution characteristics from the Federal Financial Institutions Examination Council's (FFIEC) Central Data Repository; authors' calculations.

Note: The map shows the ratio of cumulative PPPLF borrowing to PPP loans originated for community banks, based on the state in which the community bank is located.

Chart 11 shows this breakdown. As we can see, PPP lenders that received PPPLF funding disbursed PPP loans to small businesses across different industries in a way that is largely similar to that of PPP lenders that did not receive PPPLF funding.

We take a deeper look at this issue and show the breakdown by industry (of the small businesses receiving PPP loans) for PPP lenders that did receive PPPLF funding, broken down by lender type. We proceed as above and calculate total PPP loans by industry for each financial institution type. Then we match the PPPLF borrowers to PPP lenders and categorize the loans according to institution type (using our categorization based on total assets: regional bank, community bank, and nondepository institution), conditioned on having received PPPLF funding. We then show the (dollar amount) ratio of PPP loans disbursed by industry for each institution type relative to its total PPP loans disbursed.

Chart 12 shows this breakdown. Regional and community banks behaved similarly in terms of disbursing PPP loans to small businesses across sectors. However, nondepository institutions that borrowed from the PPPLF seem to have financed a slightly different clientele of small businesses with PPP loans, with a higher concentration in Transport and Warehouse Services, Support Services, Retail, and "Other" (which includes all other sectors not categorized, excluding Public Administration).

Overall, the evidence presented in this section suggests that PPPLF take-up has been significant. Furthermore, it suggests that smaller PPP lenders (including nondepository institutions) relied more heavily on PPPLF financing to originate PPP loans, and that they were likely to serve smaller businesses with fewer employees and lower payroll costs. When it comes to loan

CHART 11

Industry Breakdown of PPP Loans Originated by Financial Institutions That Received and Did Not Receive PPPLF Funding

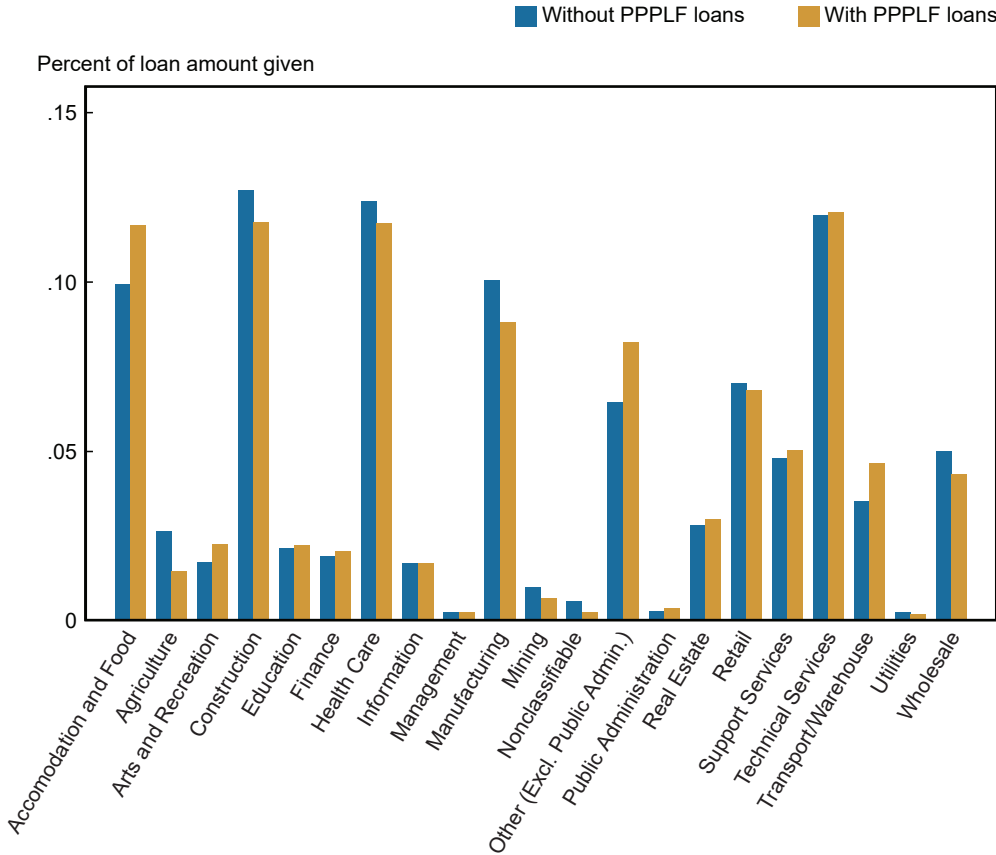

Sources: PPP reports from the U.S. Small Business Administration; PPPLF transaction-specific disclosures from the Board of Governors of the Federal Reserve System; institution characteristics from the Federal Financial Institutions Examination Council’s (FFIEC) Central Data Repository; authors’ calculations.

Note: The chart shows the share of PPP loans given to small businesses in different industries by institutions that received PPPLF funding and those that did not.

distribution by industry, there are no major differences between PPPLF-participating and PPLF-nonparticipating institutions.

4. CONCLUSION

In this article, we laid out the background and rationale for the creation of the Federal Reserve’s Paycheck Protection Program Liquidity Facility. We covered the salient features of the PPP and the PPPLF, discussed the intended aim of the facility, and analyzed the facility’s

CHART 12

Industry Breakdown of PPP Loans Originated by Type of Financial Institution, Conditional on Receiving PPPLF Funding

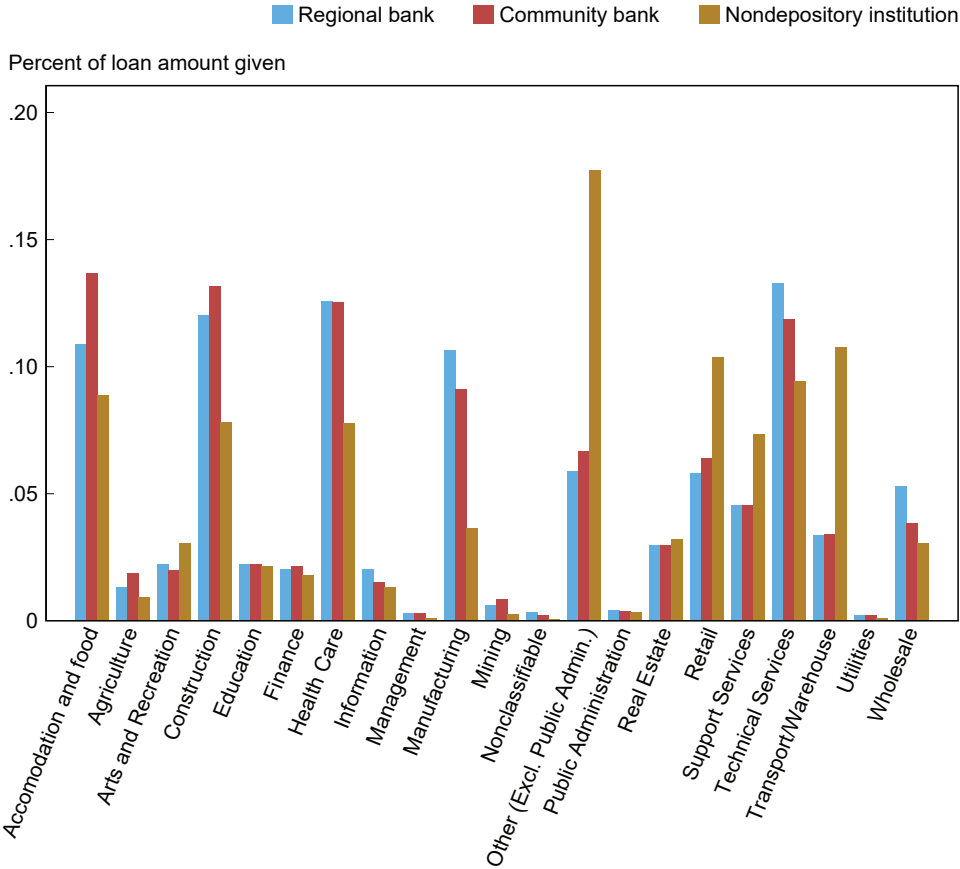

Sources: PPP reports from the U.S. Small Business Administration; PPPLF transaction-specific disclosures from the Board of Governors of the Federal Reserve System; institution characteristics from the Federal Financial Institutions Examination Council’s (FFIEC) Central Data Repository; authors’ calculations.

Note: The chart shows the breakdown by industry of PPP loans originated for PPP lenders that received PPPLF funding, by lender type.

loan take-up and impact on lender participation in the program and on PPP loan disbursements.

Empirical evidence based on the available data suggests that the PPPLF helped bolster the Paycheck Protection Program’s effectiveness. By facilitating access to credit for all PPP lenders at low rates and with a duration matching that of the underlying PPP loans, it gave lenders an incentive to participate in the PPP. The affordable access to credit was of particular relevance for smaller institutions with less than \$10 billion in total assets and for nondepository institutions, increasing the ability of these lenders to originate PPP loans. We showed that smaller PPP lenders (including nondepository institutions) relied more heavily on PPPLF financing to originate PPP loans. Given that

smaller lenders are generally more likely to reach communities underserved by larger traditional banks, the facility may have helped satisfy the guidance in the CARES Act to focus especially on providing relief to small businesses in underprivileged communities.

Furthermore, by giving favorable regulatory capital treatment to PPP loans pledged as collateral to the facility by supervised depository institutions and creating the necessary conditions for a liquid secondary market for PPP loans, the PPPLF may have helped give further impetus to broader participation by lenders in the PPP. Even though PPPLF participation is lower for larger banks than for smaller banks and nondepository institutions, the assurance of having backstop PPPLF funding available to finance PPP loan origination is likely to have positively affected PPP loan origination by larger banks as well. The positive impact of the establishment of the PPPLF comes with no expected loss to the Federal Reserve and hence taxpayers. Access to PPPLF credit is fully collateralized by pledged PPP loans, with the same principal amount and maturity as the extended loans, and PPP loans enjoy a full SBA guarantee with respect to both principal and interest.

NOTES

Acknowledgments: The author thanks Haoyang Liu for helpful discussions and feedback, an anonymous referee, and Dean Parker for excellent research assistance.

¹ Details on the program can be found at <https://www.sba.gov/funding-programs/loans/covid-19-relief-options/paycheck-protection-program>.

² An overview and details on the facility can be found at <https://www.federalreserve.gov/monetarypolicy/ppplf.htm>.

³ Eligible businesses included nonprofits, sole proprietorships, eligible self-employed individuals, independent contractors, veterans' organizations, and Tribal business concerns. Freelancers or contract or gig economy workers could also apply. The term "employee" included individuals employed on a full-time, part-time, or other basis, and businesses in certain industries could have more than 500 employees (up to 1,500 employees) if they met certain SBA criteria. The SBA applies complex affiliation criteria about parent companies and subsidiaries in order to determine a business's size; however, these were waived for the purposes of PPP loans for certain businesses. The SBA's interim final rule further specified that a business's employees must have their principal place of residence in the United States.

⁴ Applicants were ineligible for PPP loans if they were household employers, if any of the business's owners were delinquent or had defaulted on a loan from any federal agency, or if they had engaged in illegal activity or had been convicted of a felony in the last five years.

⁵ Borrowers that did not have such documentation were required to provide other supporting documentation, such as bank records, to demonstrate a qualifying payroll amount.

⁶ The maximum loan amount calculation was subject to a cap of \$100,000 annual salary per employee. For seasonal employers, this was set to 2.5 times the average monthly payments for payroll during the twelve-week period beginning February 15, 2019, or March 1, 2019.

⁷ The CARES Act specifies that the interest rate on these loans should not exceed 4 percent. The SBA and the Secretary of the Treasury initially set the interest rate at 0.5 percent. However, at a news conference on April 2, Secretary Mnuchin announced that the interest rate would be raised to 1 percent to encourage smaller lenders, including community banks, to participate in the program.

⁸ The fee reimbursement was to be made no later than five days after the disbursement of the covered loan.

⁹ Lenders could request that the SBA purchase the expected forgiveness amount of the PPP loan or pool of loans at the end of week seven of the covered period of an originated PPP loan. Before that date, the lender had to either hold the loan on its balance sheet or sell it in the secondary market.

¹⁰ See "SBA Computer System Crash Further Tangles PPP Loan Process," *PYMNTS.com*, April 7, 2020, at <https://www.pymnts.com/loans/2020/sba-computer-system-crash-further-tangles-ppp-loan-process> and "Small Business Loans Site Crashes On First Day Of Reopening," *NPR*, April 27, 2020, at <https://www.npr.org/sections/coronavirus-live-updates/2020/04/27/846197794/small-business-loans-site-crashes-on-1st-day-of-reopening>.

¹¹ See "How Central Texas' Community Banks Are Handling the Deluge of PPP Loan Applications," *Austin Business Journal*, April 6, 2020, at <https://www.bizjournals.com/austin/news/2020/04/06/how-central-texas-community-banks-are-handling-the.html>; "Judge: Banks Can Restrict PPP Applicants to Current Customers," *Arkansas Bankers Association*, April 14, 2020, at https://www.arkbankers.org/ABA/Resource_Center/bank_industry_news/Judge__Banks_Can_Restrict_PPP_Applicants_to_Current_Customers.aspx; and "Bank of America Fields 10,000 Applications Hourly for SBA's Small Business Relief Program," *San Francisco Business Times*, April 3, 2020, at <https://www.bizjournals.com/sanfrancisco/news/2020/04/03/bank-of-america-fields-10-000-applications-hourly.html>.

¹² CDFIs are financial institutions, as defined in Article 12 U.S.C. Section 4702, that are not depository institutions or credit unions.

¹³ PPP loans pledged as collateral would be valued at the full principal amount of the PPP loans, given the full SBA guarantee.

NOTES (CONTINUED)

¹⁴ See, for example, “Lenders Get 2nd Chance to Correct PPP Flaws,” *Banking Dive*, April 27, 2020. <https://www.bankingdive.com/news/lenders-second-chance-correct-ppp-flaws/576811/>.

¹⁵ RSSD IDs are unique identifiers assigned to commercial banks or bank holding companies by the Federal Reserve, used to identify institutions in regulatory reports, such as the Call Report and Y9-C. ABA routing numbers are identifiers assigned by the American Bankers Association to federal or state chartered financial institutions eligible to maintain an account at a Federal Reserve Bank.

¹⁶ As described in Section 1, PPP loan approvals through May 31, 2021, amounted to nearly \$800 billion.

REFERENCES

- Anbil, S., M. A. Carlson, and M.-F. Styczynski. 2021. “The Effect of the PPPLF on PPP Lending by Commercial Banks.” FEDS Working Paper no. 2021-030, June.
- Autor, D., D. Cho, L. D. Crane, M. Goldar, B. Lutz, J. Montes, W. B. Peterman, D. Ratner, D. Villar, and A. Yildirmaz. 2020. “An Evaluation of the Paycheck Protection Program Using Administrative Payroll Microdata.” MIT Working Paper, July.
- Barraza, S., M. Rossi, and T. J. Yeager. 2020. “The Short-Term Effect of the Paycheck Protection Program on Unemployment.” SSRN 3667431, August.
- Barrios, J. M., M. Minnis, W. C. Minnis, and J. Sijthoff. 2020. “Assessing the Payroll Protection Program: A Framework and Preliminary Results.” SSRN 3600595, June.
- Eggleston, M. C. 2021. “Fed’s PPP Liquidity Facility Provides CDFIs Balance Sheet Relief.” Federal Reserve Bank of St. Louis, BRIDGES 1 (February).
- Erel, I., and J. Liebersohn. 2020. “Does Fintech Substitute for Banks? Evidence from the Paycheck Protection Program.” NBER Working Paper no. w27659, August.
- Granja, J., C. Makridis, C. Yannelis, and E. Zwick. 2020. “Did the Paycheck Protection Program Hit the Target?” NBER Working Paper no. w27095, May.
- James, C. M., Jing L., and Y. Sun. 2021. “Time Is Money: Real Effects of Relationship Lending: Evidence from Community Bank Lending in the Paycheck Protection Program.” SSRN 3633339, February 24.
- Li, L., and P. Strahan. 2020. “Who Supplies PPP Loans (and Does It Matter)? Banks, Relationships, and the COVID Crisis.” NBER Working Paper no. w28286, December.
- Liu, H., and D. Volker. 2020a. “Where Have the Paycheck Protection Loans Gone So Far?” Federal Reserve Bank of New York *Liberty Street Economics*, May 6.
- Liu, H., and D. Volker. 2020b. “The Paycheck Protection Program Liquidity Facility (PPPLF).” Federal Reserve Bank of New York *Liberty Street Economics*, May 20.
- Lopez, J. A., and M. M. Spiegel. 2021. “Small Business Lending under the PPP and PPPLF Programs.” Federal Reserve Bank of San Francisco Working Paper no. 2021-10, April.

THE FEDERAL RESERVE'S MARKET FUNCTIONING PURCHASES

Michael Fleming, Haoyang Liu, Rich Podjasek, and Jake Schurmeier

OVERVIEW

- In March 2020, massive customer selling of U.S. Treasury securities and agency mortgage-backed securities (MBS) triggered by the COVID-19 pandemic overwhelmed dealers' capacity to intermediate trades, contributing to a marked deterioration of market functioning.
- The Federal Reserve promptly took numerous steps to address the market disruptions, including the initiation of market functioning purchases of Treasury securities and agency MBS.
- Purchases quickly expanded to over \$100 billion per day as the Fed announced plans to buy securities "in the amounts needed" to support market functioning and the effective transmission of monetary policy.
- Market liquidity improved steadily after mid-March, suggesting that the Fed's efforts were effective, and the security purchases were scaled back accordingly.

The COVID-19 pandemic had extraordinary effects on U.S. financial markets. U.S. Treasury securities are usually thought to benefit from a flight to safety during times of crisis, as investors exit positions with greater credit risk and bid up the prices of Treasury securities (Noeth and Sengupta 2010). Treasury prices followed this pattern in the early months of the pandemic, with the yield on the ten-year note (which moves inversely to its price) plunging from 1.92 percent on December 31, 2019, to a record low 0.55 percent on March 9, 2020. Starting March 10, however, Treasury prices reversed and fell sharply, with the yield on the ten-year note rising 65 basis points between March 9 and March 18. Prices of agency mortgage-backed securities (MBS) dropped even more steeply over this period, with the yield for current coupon agency MBS rising roughly 100 basis points.

The unusual price changes were accompanied by a marked deterioration of market functioning (Duffie 2020; Logan 2020a, 2020b). Treasury market liquidity deteriorated to its worst levels since the 2007-09 global financial crisis,

Michael Fleming is head of Capital Markets Studies in the Federal Reserve Bank of New York's Research and Statistics Group. Haoyang Liu is a senior research economist and advisor at the Federal Reserve Bank of Dallas. Rich Podjasek is a capital markets trading principal in the New York Fed's Markets Group. Jake Schurmeier was a senior trader/analyst in the Bank's Markets Group at the time this article was written. Emails: michael.fleming@ny.frb.org, haoyang.liu@dal.frb.org, rich.podjasek@ny.frb.org.

The views expressed in this article are those of the authors and do not necessarily reflect the position of the Federal Reserve Bank of New York, the Federal Reserve Bank of Dallas, or the Federal Reserve System. To view the authors' disclosure statements, visit https://www.newyorkfed.org/research/epr/2022/epr_2022_MFP_fleming.

amidst the worst recession since World War II, with wide bid-ask spreads, low market depth, and a high price impact of trades (Fleming 2020; Fleming and Ruela 2020). Agency MBS bid-ask spreads and price impact followed a similar pattern. Pricing dislocations also arose among securities with similar cash flow characteristics, suggesting a breakdown of arbitrage relationships (Schrimpf, Shin, and Sushko 2020).

The Federal Reserve promptly took numerous actions to address the market disruptions (Fleming, Sarkar, and Van Tassel 2020; Clarida, Duygan-Bump, and Scotti 2021; Federal Reserve Bank of New York 2021). On March 15, 2020, in particular, the Federal Open Market Committee (FOMC) announced that it would increase its holdings of Treasury securities by at least \$500 billion and its holdings of agency MBS by at least \$200 billion to support market functioning and hence the flow of credit to households and businesses (Board of Governors 2020a).¹ It then announced on March 23 that it would continue to purchase Treasury securities and agency MBS “in the amounts needed” to support market functioning and the effective transmission of monetary policy (Board of Governors 2020b).

The Fed's purchases were expected to improve market functioning through multiple channels, including by offsetting the massive sales being undertaken by foreign investors, hedge funds, and mutual funds (Logan 2020a, 2020b). A key role of dealers is to intermediate customer flows, and dealers in fact sharply increased their securities holdings in response to customer sales. However, dealers became overwhelmed by the level and persistence of the sales amidst unusually high volatility and historic trading volume. Moreover, dealers entered the pandemic with already high Treasury holdings, further limiting their capacity to absorb the immense selling pressure.

The most striking aspects of the market functioning purchases were their innovativeness and their unprecedented speed and scale. In terms of speed and scale, the purchases quickly reached over \$100 billion per day and totaled over \$2 trillion between March 13 and April 30 alone. In terms of innovativeness, the Fed varied the pace and distribution of purchases based on observable measures of market functioning, reflecting the particular motivation for the purchases. It also adjusted the settlement timing of some MBS operations, allowing market participants to quickly obtain cash for their MBS sales, reducing funding pressures in the market. The Fed also for the first time purchased agency commercial mortgage-backed securities (CMBS) to support the smooth functioning of this important market (Park, Gouny, and Liu 2020).

There were also aspects of the market functioning purchases that were not new. In particular, the Fed relied on a tool (open market operations) that it commonly uses in its implementation of monetary policy. In addition, the Fed purchased securities in large quantities during and after the global financial crisis (albeit for different purposes) and had purchased securities to support market functioning in episodes before that. More generally, the Fed was created, at least in part, to ensure a more stable financial system, and it has traditionally been a liquidity provider of last resort, so the market functioning purchases fit well within the Fed's purview.

While it is difficult to pin down the effects of the Fed's purchases amidst the pandemic and numerous policy actions, the evidence suggests that they were effective. Many Treasury market liquidity measures reached their nadir on Friday, March 13, before improving immediately after the initiation of the purchases was announced on Sunday, March 15. Nonetheless, conditions remained unusually illiquid through March 23, when the Fed dropped explicit quantity limits on its total purchases, but improved notably the next day. Agency MBS liquidity metrics broadly followed a similar pattern. As market conditions improved, purchases were scaled

back, dropping from a daily average of \$104 billion in late March to \$18 billion in late April and \$9.5 billion in late May.

The rest of the article is organized as follows. In Section 1, we present evidence on the market disruptions caused by the pandemic that spurred the Fed to respond. Section 2 then discusses how the market functioning purchases were conducted, what they were intended to do, and their limitations and drawbacks. In Section 3, we provide information on the purchases' effects and their evolution. Section 4 concludes.

1. THE MARCH 2020 MARKET DISRUPTIONS

1.1. Early 2020

Fixed income yields declined at a modest pace in early 2020 amidst limited financial market volatility and generally increasing equity prices. The ten-year Treasury yield declined about 60 basis points (from 1.92 percent to 1.34 percent) between December 31, 2019, and February 26, 2020 (Chart 1). MBS prices were stable relative to Treasury prices, with the option-adjusted-spread (OAS) relative to Treasury securities for current coupon universal mortgage-backed securities (UMBS) staying within a narrow range of 24-31 basis points (Chart 2).² The World Health Organization had been informed of the COVID-19 outbreak on December 31, 2019, but the first reported case in the United States did not come until January 21, 2020, and the first possible community transmission in the United States was not announced until February 26.³

Increased concerns about the effects of the pandemic drove fixed income yields and equity prices sharply lower and volatility higher. Between February 26 and March 9, the ten-year Treasury yield plunged nearly 80 basis points, going from 1.34 percent to a record low of 0.55 percent. Changes in agency MBS yields tracked changes in Treasury yields during this time. The yield for current coupon UMBS dropped from 2.17 percent on February 26 to 1.49 percent on March 9, with the OAS remaining fairly stable around 30 basis points. The S&P 500 equity index dropped 3 percent or more on February 24, 25, and 27, and then 7.6 percent on March 9, triggering a circuit breaker that temporarily halted trading.

Treasury liquidity, which had shown little signs of stress through late February, started to deteriorate, most notably on Friday, March 6, and Monday, March 9. The spreads between the highest bid prices and the lowest ask prices for the on-the-run (most recently auctioned) five-, ten-, and thirty-year securities widened (Chart 3) and the quantities available to transact at those quoted prices declined (Chart 4).⁴ Moreover, price impact—a measure of how much trading in a given direction affects prices—increased (Chart 5). There is also evidence of widening bid-ask spreads (Chart 6) and increased price impact (Chart 7) for agency MBS at this time, although the trend is less clear, perhaps because the MBS liquidity measures are estimated less precisely.⁵

1.2 The Dash for Cash

After sharply falling, longer-term yields abruptly reversed between March 9 and March 18, with the ten-year yield quickly rising 65 basis points (from 0.55 percent to 1.20 percent) and

CHART 1
Treasury Yield and Price Volatility in Early 2020

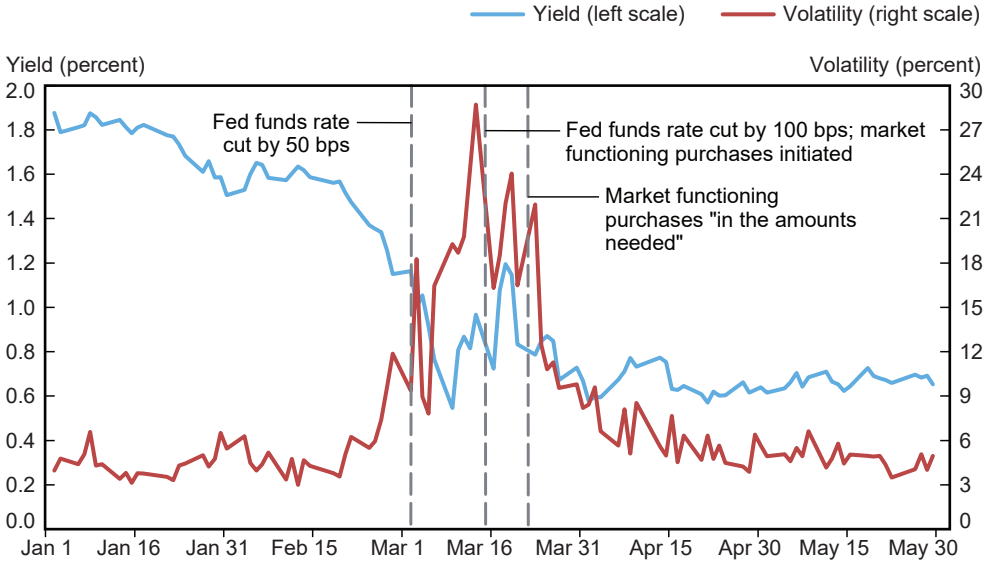

Source: Authors' calculations, based on data from BrokerTec.

Notes: The chart plots the closing yield and realized price volatility by day for the on-the-run ten-year note from January 1 to May 31, 2020. Realized price volatility is calculated by summing squared five-minute returns (log changes in midpoint prices) for New York trading hours (7:30 a.m. – 5 p.m.), annualizing by multiplying by 252, and then taking the square root.

CHART 2
Agency MBS Yield and Option-Adjusted Spread in Early 2020

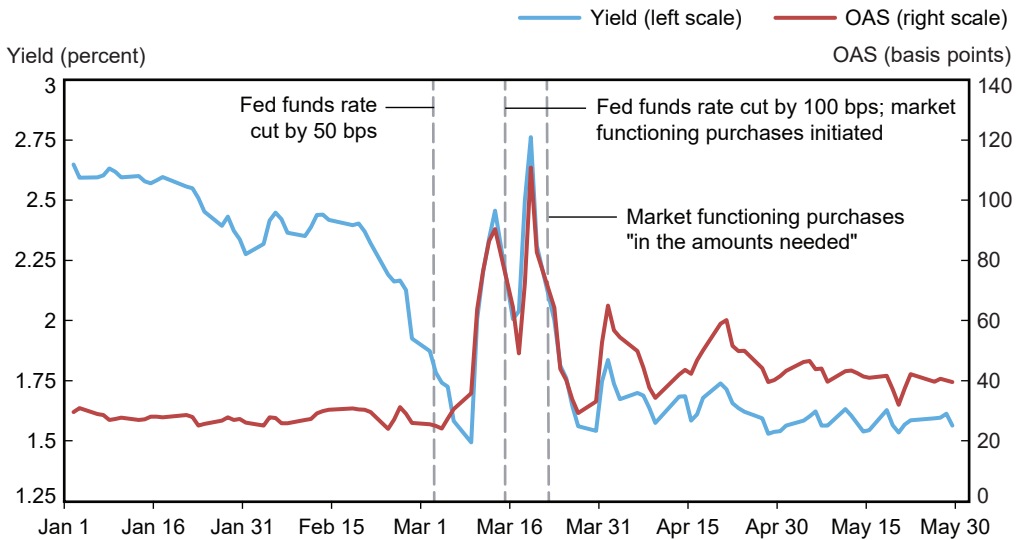

Source: J.P. Morgan Markets.

Note: The chart plots the yield on thirty-year current coupon UMBS and the option-adjusted spread (OAS) for such securities by day from January 1 to May 31, 2020.

CHART 3
Treasury Security Bid-Ask Spreads

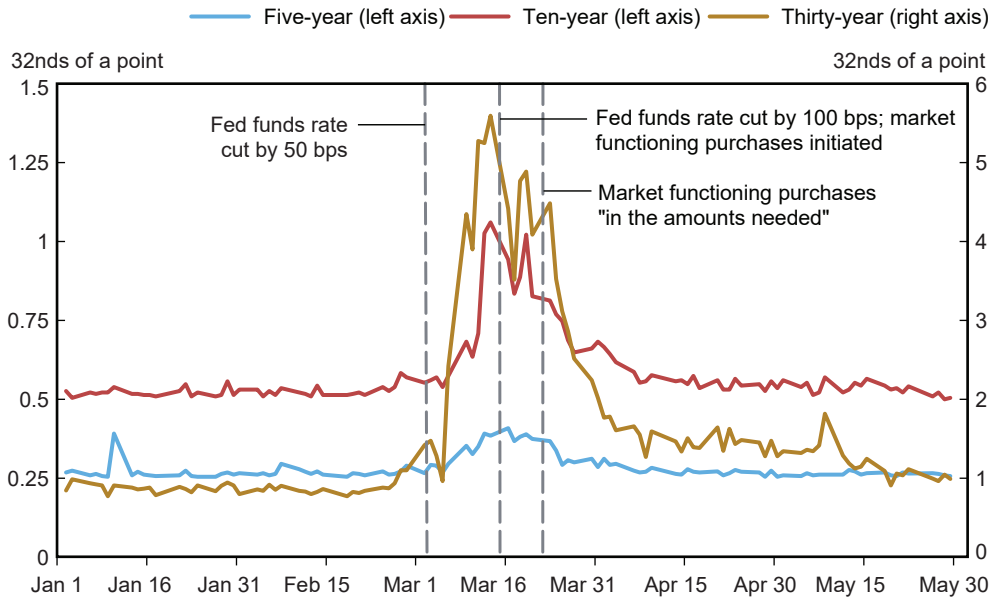

Source: Authors' calculations, based on data from BrokerTec.

Notes: The chart plots average daily quoted bid-ask spreads for the on-the-run five-, ten-, and thirty-year securities in the interdealer market from January 1 to May 31, 2020. Spreads are measured in 32nds of a point, where a point equals one percent of par.

the yield for current coupon UMBS rising about 100 basis points (from 1.49 percent to 2.50 percent).⁶ Treasury volatility also rose sharply, peaking at its highest level since the global financial crisis on March 13, and the S&P 500 declined, on net, amid unusually high equity volatility.⁷ In addition, Treasury liquidity deteriorated, with bid-ask spreads (Chart 3) and price impact (Chart 5) reaching their highest levels, and order book depth (Chart 4) its lowest levels, since the global financial crisis, mostly on March 13.⁸ Agency MBS liquidity also dried up, with bid-ask spreads (Chart 6) and price impact (Chart 7) peaking around March 19.

There were also pricing dislocations among securities with similar cash flow characteristics, suggesting a breakdown of arbitrage relationships. In the Treasury market, the yield spread between on-the-run and off-the-run securities with similar maturities widened (Chart 8), suggesting that investors were placing greater value on the relatively more liquid on-the-run securities (and/or that the liquidity of the off-the-run securities had worsened to a greater extent). Futures prices also became detached from the prices of the associated cash securities, and the dispersion of yields around a smoothed yield curve increased (Duffie 2020; Schrimpf, Shin, and Sushko 2020; Barth and Kahn 2021).

For agency MBS, price dislocations arose between the specified pool (SP) market and the to-be-announced (TBA) market. TBA prices generally serve as an effective lower bound for prices in the SP market. This is because TBA sellers tend to deliver less valuable pools to settle TBA contracts (given the cheapest-to-deliver option), resulting in lower

CHART 4
Treasury Security Order Book Depth

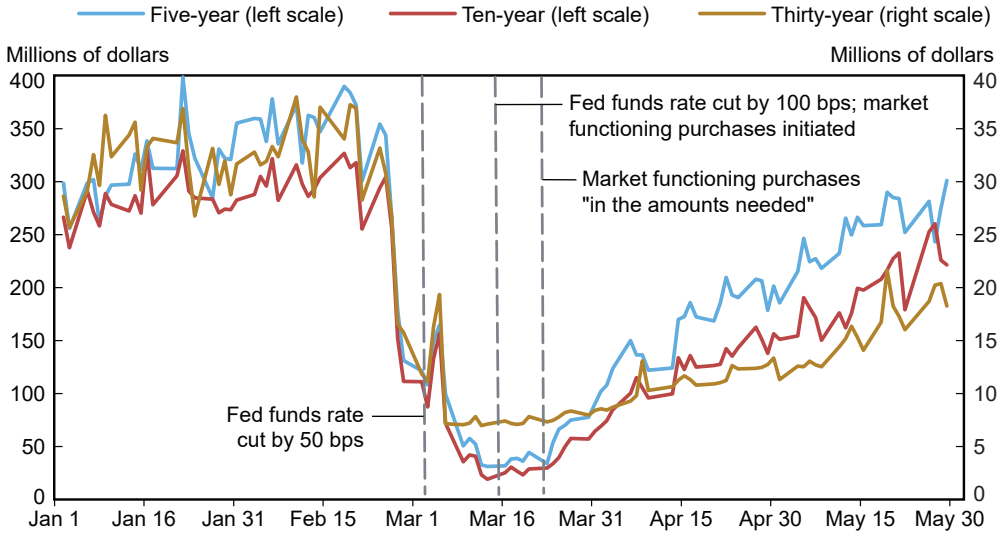

Source: Authors' calculations, based on data from BrokerTec.

Notes: The chart plots average daily depth for the on-the-run five-, ten-, and thirty-year securities in the interdealer market from January 1 to May 31, 2020. Data are for order book depth at the inside five tiers, averaged across the bid and offer sides. Depth is measured in millions of dollars par.

CHART 5
Treasury Security Price Impact

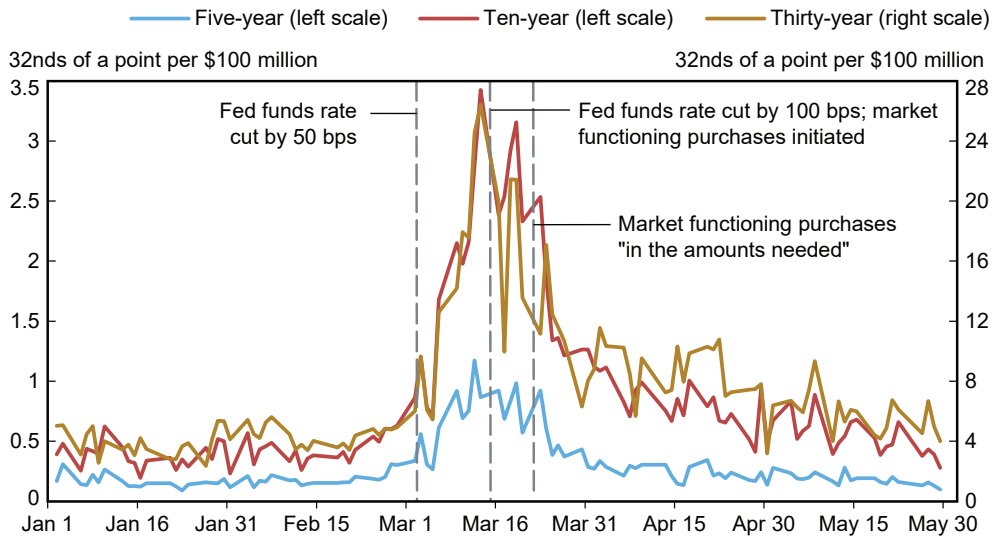

Source: Authors' calculations, based on data from BrokerTec.

Notes: The chart plots slope coefficients from daily regressions of one-minute price changes on one-minute net order flow (buyer-initiated trading volume less seller-initiated trading volume) for the indicated on-the-run securities in the interdealer market from January 1 to May 31, 2020. Price impact is measured in 32nds of a point per \$100 million, where a point equals 1 percent of par.

CHART 6
Agency MBS Bid-Ask Spreads

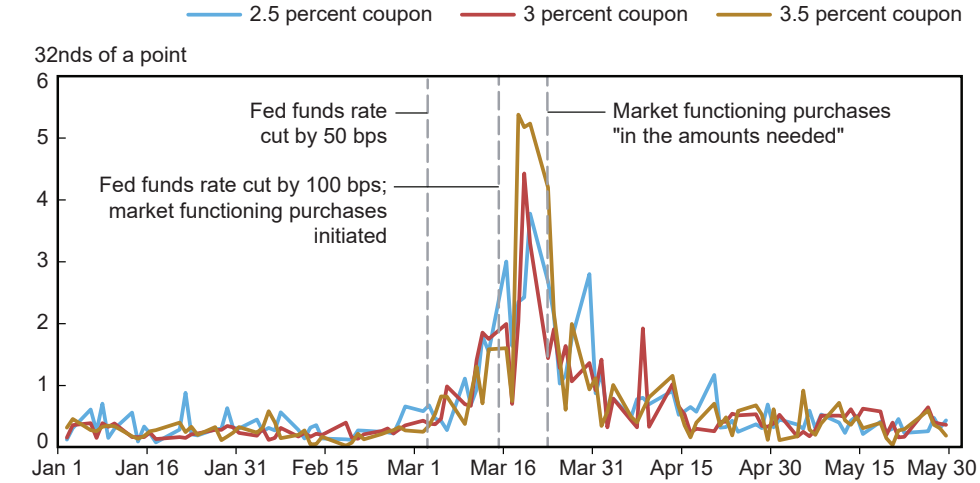

Source: Authors' calculations, based on data from FINRA TRACE.

Note: The chart plots average daily effective bid-ask spreads for thirty-year 2.5 percent, 3 percent, and 3.5 percent coupon UMBS in the TBA market from January 1 to May 31, 2020. Average spreads are first calculated for each coupon and half hour as dealers' volume-weighted average sell price minus dealers' volume-weighted average buy price for dealer trades with customers. Daily volume-weighted averages are then calculated from the positive half-hour averages.

CHART 7
Agency MBS Price Impact

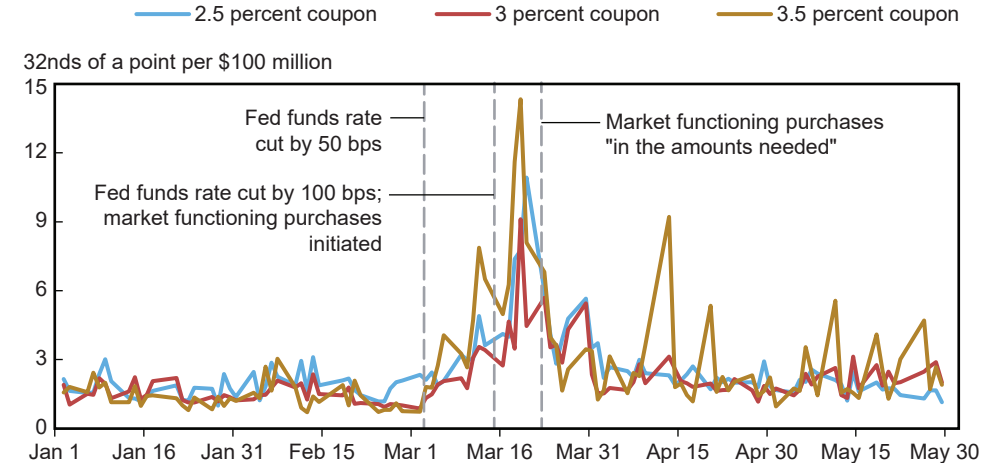

Source: Authors' calculations, based on data from FINRA TRACE.

Notes: The chart plots average daily Amihud (2002) price impact measures for thirty-year 2.5 percent, 3 percent, and 3.5 percent UMBS in the TBA market from January 1 to May 31, 2020. The measures are first calculated for each coupon and trade as the absolute value of the price change from the preceding trade divided by trade size. Daily volume-weighted averages are then calculated from the individual trade measures. For trades between dealers, only reported buys are considered so as to avoid double-counting of trades.

CHART 8
On-the-Run/Off-the-Run Treasury Spreads

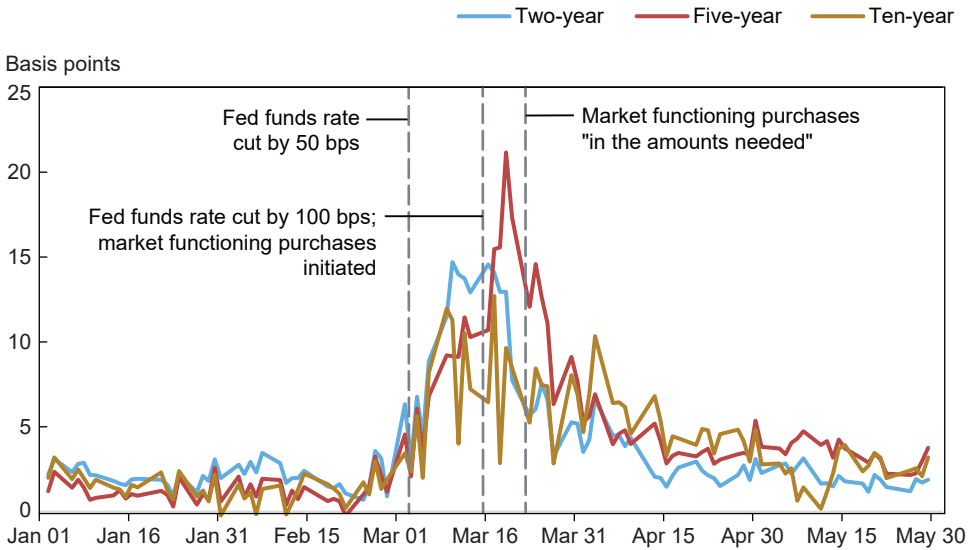

Source: Authors' calculations, based on data from BrokerTec.

Notes: The chart plots on-the-run/off-the-run spreads for the two-, five-, and ten-year notes by day from January 1 to May 31, 2020. The spreads are calculated (using parameters from the Nelson-Siegel-Svensson model of Gurkaynak, Sack, and Wright [2007]) as the yields of hypothetical securities with the same cash flows as the on-the-run two-, five-, and ten-year notes less the actual yields of the notes.

prices. To avoid this discount in the TBA market, owners of premium MBS prefer to sell their securities in the SP market. The gap between SP and TBA prices, also known as pay-up, shrank dramatically in March 2020 (Chart 9). One explanation is that investors sold MBS disproportionately in the SP market (in which time to settlement can be shorter) because they could not wait for the longer time to settlement in the TBA market to receive cash for their sales (Chen et al. 2020).

Another dislocation in the agency MBS market concerned pricing relative to the Treasury market. Agency MBS are guaranteed by an agency of the U.S. government (Ginnie Mae) or a government-sponsored enterprise (Fannie Mae and Freddie Mac), and hence considered almost as safe as Treasury securities. This helps explain agency MBS' remarkably stable OAS before the COVID-19 market stress (Chart 2). However, after the start of the liquidity crisis, pricing of agency MBS relative to Treasury securities experienced large swings, even on an intraday basis (Chart 10).

A defining feature of this episode, aside from (and related to) the rising Treasury yields, was the massive selling of off-the-run Treasury notes and bonds and agency MBS by a broad range of investors (Chart 11). Mutual funds faced investor outflows and chose to first sell their most liquid assets to meet redemptions (Ma, Xiao, Zeng 2020). There was also record selling of Treasury notes and bonds by foreign investors, including foreign central banks (Duffie 2020; Logan 2020a). Unwinding of relative value trades was likely a

CHART 9
Specified Pool and TBA Prices for 3 Percent UMBS

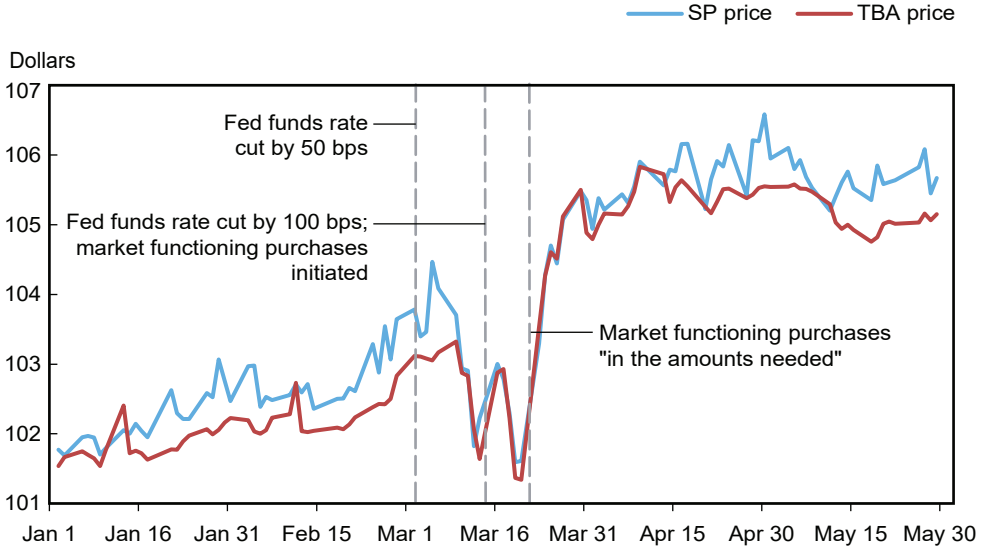

Source: Authors' calculation, based on FINRA TRACE data.

Notes: The chart plots the average daily price for thirty-year 3 percent UMBS in the TBA market and the average daily price for TBA-eligible thirty-year 3 percent UMBS in the specified pool (SP) market. Price is in dollars per \$100 par.

CHART 10
Agency MBS Basis Volatility

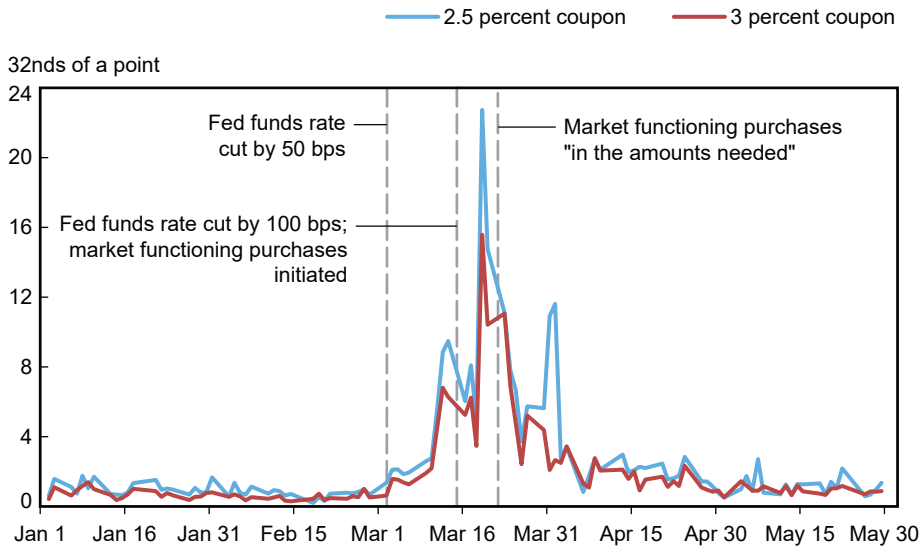

Source: Authors' calculations, based on data from Citi Velocity.

Notes: The chart plots the daily standard deviation of hourly changes in the thirty-year UMBS five-year Treasury basis for the 2.5 percent and 3 percent coupons in the TBA market from January 1 to May 31, 2020.

CHART 11

Customer Sales of Off-the-Run Treasury Notes and Bonds

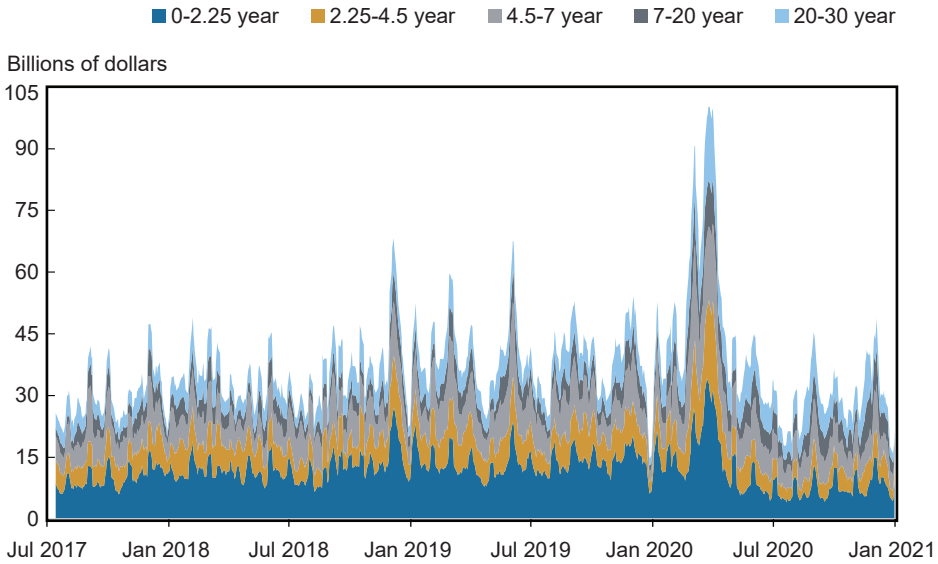

Source: Authors' calculations, based on FINRA TRACE data.

Notes: The chart plots five-day moving averages of gross daily customer sales to dealers of off-the-run Treasury notes and bonds from July 10, 2017 (when Treasury TRACE reporting began) to December 31, 2020. Sales are measured in billions of dollars par.

contributing factor to the selling. Leveraged investors that sought to profit from small pricing differences between Treasury securities in the cash market and the corresponding futures contracts reportedly started unwinding their positions as futures prices rose, causing both volatility and margins to increase and resulting in a classic margin spiral in which illiquidity, volatility, and increased margins reinforced one another (Schimpf, Shin, and Sushko 2020; Barth and Kahn 2021). Some of the selling may not have been for immediate liquidity needs, but a precaution against a further deterioration in market functioning in a remote work environment (Logan 2020b).

The customer selling of Treasury securities was offset to a certain extent by substantial dealer purchases. Broker-dealers provide liquidity by standing ready to take the opposite side of their customers' trades, and by holding such positions until they can be offset in the inter-dealer market or with other customers. With higher price volatility, less stable pricing relationships between Treasury instruments, and lower overall market liquidity, making markets became much riskier for dealers in March 2020. Dealers faced balance sheet constraints and internal risk limits, preventing them from meeting the dramatic increase in liquidity demand on normal terms.

Broker-dealers provide liquidity in the MBS market as well as the Treasury market. In March 2020, dealers were, on net, buying from customers in the SP market and selling to customers in the TBA market and, in so doing, absorbing massive selling pressure in the SP market (Chart 12). This participation stands in contrast to the 2013 fixed income sell-off, when

CHART 12

Customer Sales of Agency MBS

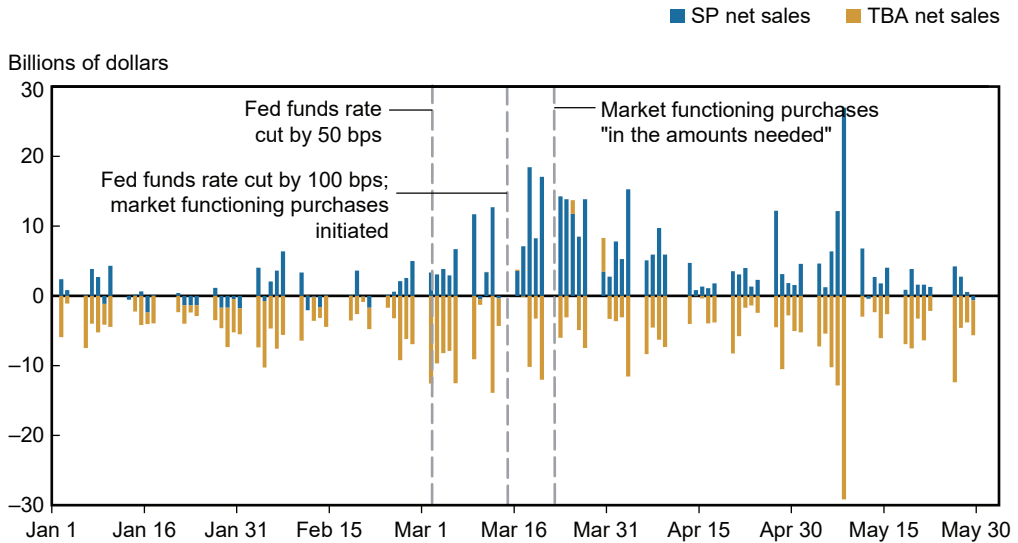

Source: Authors' calculations, based on FINRA TRACE data.

Notes: The chart plots net customer sales to dealers of Fannie Mae and Freddie Mac mortgage-backed securities (MBS) in the SP and TBA markets by day from January 1 to May 31, 2020. Positive (negative) numbers imply net customer sales to (purchases from) dealers. Quantities are measured in billions of dollars par.

dealers reduced their net positions in agency MBS (Adrian et al. 2013). However, price dislocations, including reduced pay-up, continued through at least early April, suggesting that dealer liquidity provision was insufficient.

Dealer intermediation led to a sharp increase in primary dealers' holdings of Treasury notes and bonds and agency MBS (Chart 13).⁹ In the week ending Wednesday, March 18, primary dealers' agency MBS holdings reached \$113 billion, a record high, and their Treasury note and bond holdings \$222 billion, just slightly below their May 2019 high. The four-week increase in primary dealer holdings was also the highest on record for both Treasury notes and bonds and agency MBS. The sharp increases occurred amidst a backdrop of elevated dealer positions, which had increased notably in late 2018. Dealers' holdings entering the pandemic, combined with the elevated uncertainty and volatility, limited their capacity to absorb the immense customer flows.

The challenges facing intermediaries were not limited to dealers. Another important set of intermediaries—principal trading firms (PTFs)—reduced their share of trading activity sharply in March 2020 (Chart 14). A PTF is a firm that invests for its own account, and that often employs automated trading strategies in which speed is a key element. Such firms account for most activity on the electronic interdealer broker platforms (Harkrader and Puglia 2020). The high volatility, illiquidity, and unpredictability of flows in March 2020 caused PTFs to reduce their intermediation capacity relative to dealers and hence PTFs' share of trading activity to decline.¹⁰ Reduced liquidity in the interdealer market in turn exacerbated dealers' challenges in intermediating customer flows.

CHART 13

Primary Dealer Positions in Treasury Notes and Bonds and Agency MBS

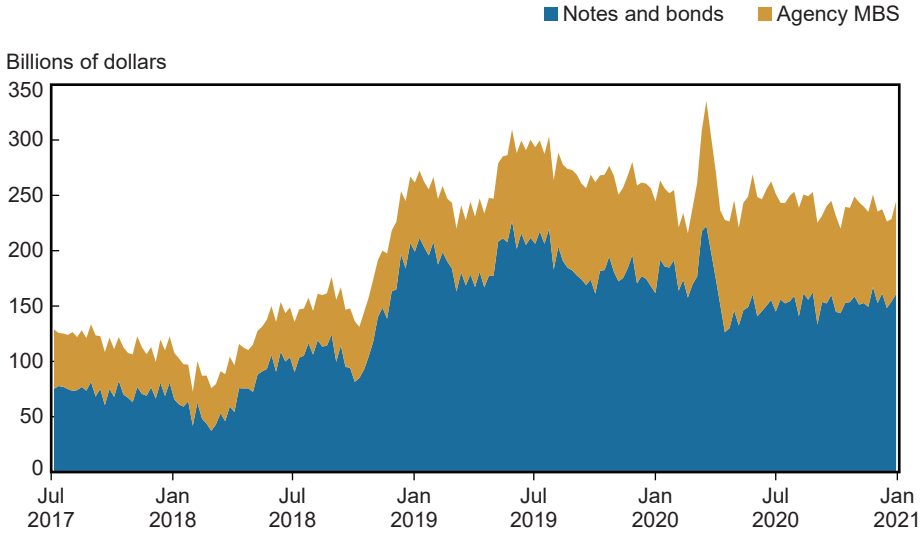

Source: Authors' calculations, based on data from the FR 2004A Weekly Report of Dealer Positions.

Notes: The chart plots primary dealers' aggregate net positions in Treasury notes and bonds, and agency mortgage-backed securities (MBS) from the week ending July 5, 2017, to the week ending December 29, 2020.

CHART 14

PTFs' Treasury Security Trading Volume Shares on Electronic IDB Platforms

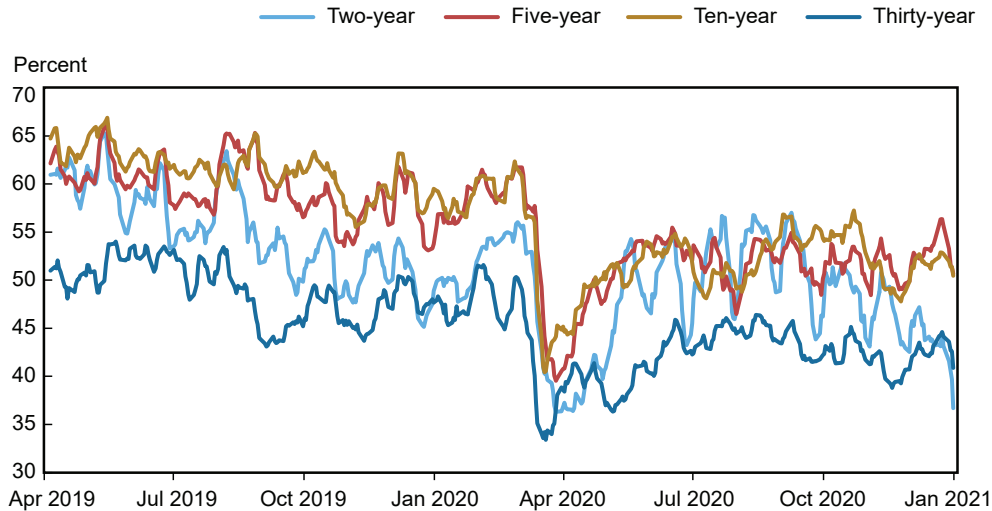

Source: Authors' calculations, based on FINRA TRACE data.

Notes: The chart plots five-day moving averages of principal trading firms' (PTFs) shares of Treasury security trading volume on electronic interdealer broker (IDB) platforms from April 1, 2019 (when such data on PTFs' activity became available) to December 31, 2020. All activity on electronic IDBs involves notes and bonds, with nearly all activity attributable to the on-the-run notes and bonds in particular.

1.3 The Fed's Response

While the FOMC cut the federal (fed) funds target rate on March 3, in light of the risks to economic activity, the Fed's responses to the market disruptions specifically began several days after that. The New York Fed's Open Market Trading Desk increased the sizes of its repurchase agreement (repo) operations on March 9, and announced on March 11 that it would offer longer term repos, "to support the smooth functioning of funding markets."¹¹

On March 12, the Desk then announced that, pursuant to instruction from the Chair, it was changing the maturity composition of its reserve management purchases "to support functioning in the market for U.S. Treasury securities," and on March 13 that it was bringing forward these and other purchases "to address highly unusual disruptions in the market for Treasury securities associated with the coronavirus outbreak" and "to foster smooth Treasury market functioning and efficient and effective policy implementation."¹²

On March 15, the FOMC announced that it would increase its holdings of Treasury securities by at least \$500 billion and its holdings of agency MBS by at least \$200 billion over coming months "to support the smooth functioning of markets ... that are central to the flow of credit to households and businesses" (Board of Governors 2020a). On March 23, the FOMC announced additional steps to address market strains by continuing to purchase Treasury securities and agency MBS "in the amounts needed to support smooth market functioning and effective transmission of monetary policy to broader financial conditions" (Board of Governors 2020b). The committee also announced March 23 that it would include purchases of agency CMBS in its agency MBS purchases.

While our focus is on the market functioning purchases, the Fed took additional actions in March and early April 2020 (aside from changes to its repo operations mentioned above) to mitigate the disruptions to the Treasury and related markets: (1) It established the Primary Dealer Credit Facility to provide funding to primary dealers, which are key market makers for Treasury securities and other securities; (2) It made changes to standing swap lines (in coordination with other central banks) and reintroduced temporary swap lines with additional central banks to lessen strains in U.S. dollar funding markets; (3) It launched the FIMA Repo Facility to allow foreign central banks to raise U.S. dollars against their holdings of Treasury securities at the Fed, reducing their incentive to sell Treasury securities in the open market; and (4) It temporarily changed its supplementary leverage ratio rule, excluding Treasury securities and deposits at the Fed from the calculation of the rule for holding companies, thereby providing the firms increased balance sheet space to act as financial intermediaries.

The Fed took numerous other actions to address the economic and financial disruptions caused by the pandemic. The FOMC cut the fed funds target rate on March 3, as mentioned above, and again on March 15—concurrent with the announcement of market functioning purchases—citing risks to economic activity from the coronavirus. The Fed also announced other measures on March 15 to support the credit needs of households and businesses, including lowering the primary credit rate (the discount window borrowing rate for banks). Moreover, the Fed established a series of funding and liquidity facilities in coordination with the U.S. Treasury to support credit to businesses of varying sizes, to mitigate disruptions in short- and medium-term funding markets, and to help state and local governments manage cash flow pressures.¹³

2. THE PURCHASES' RATIONALE, OPERATIONS, AND LIMITATIONS

2.1 Rationale and Precedent for the Purchases

The asset purchases were expected to support market functioning through multiple channels (see Logan 2020b, for additional details). First, the purchases would alleviate pressure on intermediaries by absorbing some of the extraordinary Treasury and MBS sales, which could help restore two-way trading to the market and hence market liquidity. Second, the purchases were expected to reduce pricing dislocations, as the Fed tends to buy securities that are undervalued. Aside from these direct effects, the Fed's commitment to buying securities "in the amounts needed" might be expected to reduce selling by investors that did not need the cash at the time, but that might choose to sell to guard against the risk of market functioning worsening further.

Note that there is nothing uncommon about the Fed buying Treasury securities and more recently agency MBS, but what was unusual was the speed and magnitude of the purchases and the motivation. The Fed has regularly conducted secondary market trades in Treasury securities, and in recent years agency MBS, to manage the supply of reserves held by banks. Before the pandemic, the Fed was engaged in reserve management purchases of Treasury bills at a pace of \$60 billion per month. In addition, principal payments from agency debt and agency MBS—up to \$20 billion per month—were being reinvested in Treasury securities (across security types), and principal payments above \$20 billion were being reinvested in agency MBS.

There was also recent precedent for asset purchases in sizeable amounts with the Fed's large-scale asset purchases (LSAPs) conducted between December 2008 and October 2014, although the earlier LSAPs were at a lesser speed and scale, and had lowering interest rates as a primary motivation. In the first LSAP program, the Fed purchased \$1.25 trillion of agency MBS and \$175 billion of agency debt securities "to reduce the cost and increase the availability of credit for the purchase of houses" (Board of Governors 2008) and \$300 billion of Treasury securities "to improve conditions in private credit markets" generally (Board of Governors 2009).

Going back further, there are instances of the Fed purchasing securities to support Treasury market functioning. Garbade and Keane (2020) describe such episodes from 1939, 1958, and 1970, and track the origins of the Fed's concern with, and responsibility for, an orderly market for Treasury securities to a 1936 FOMC meeting.

At a more general level, Fed officials have explained how ensuring liquid and smoothly functioning financial markets are essential roles for central banks. New York Fed President Williams, for example, explained how no private institution has the ability to provide liquidity at the speed or scale of the Fed and other central banks, and how the Fed was originally created to ensure the stability of the financial system (Williams 2020). The market functioning purchases are one way the Fed provided liquidity, thereby promoting smooth market functioning and hence financial stability.

2.2 How the Purchases Worked

The Fed's market functioning purchases were generally executed in a similar manner as past asset purchases. That said, their differing motivation led to differences in the speed and magnitude of the purchases, and changing operation terms over time.

Counterparties

The market functioning purchases were conducted with the primary dealers, as is typical for such “permanent” open market operations.¹⁴ Primary dealers are trading counterparties of the New York Fed in its implementation of monetary policy, as noted earlier. They are also key intermediaries in financial markets, transacting with customers in their role as market makers. In the Fed’s purchase operations, primary dealers are expected to submit offers for both themselves and their customers.

Execution method

The Desk conducts secondary market purchases of Treasury securities and agency MBS via FedTrade, its proprietary trading system.¹⁵ The purchases are conducted using multiple-price competitive auctions, with each dealer able to submit several offers on each security in an operation. For agency MBS, offers in FedTrade operations are evaluated based on their proximity to prevailing market prices at the auction close, whereas, for Treasury securities, offers are evaluated on both their proximity to market prices and measures of relative value.

Securities purchased

The Desk’s market functioning purchases of Treasury securities were primarily of nominal coupon securities (that is, notes and bonds) and Treasury Inflation-Protected Securities (TIPS).¹⁶ The investable universe included every available CUSIP within these security types with a few exceptions. For both security types, the Desk excluded securities in which the Fed owned 70 percent of the outstanding amount, and securities that were trading with heightened scarcity value in the repo market. For notes and bonds, the Desk further refrained from purchasing the most recently issued security, and securities with four weeks or less to maturity. For TIPS, the Desk refrained from purchasing securities with one year or less to maturity.

Agency MBS purchases were concentrated in recently produced coupons in thirty- and fifteen-year fixed-rate MBS in the TBA market. The TBA market is highly liquid and is closely tied to primary mortgage rates because when borrowers lock in their mortgage rates, lenders often simultaneously short in the TBA market to hedge their interest rate risk, effectively offloading these mortgages before they are originated (Fuster, Lo, and Willen 2017). It follows then that liquidity and pricing in the TBA market crucially affect homeowners’ mortgage rates and credit supply.

Purchase schedule, frequency, and amounts

At the start of the market functioning purchases in March 2020, operation terms were adjusted as needed to foster smooth market functioning and efficient and effective policy implementation (FAQs: Treasury Purchases, April 17, 2020). Initially, Treasury operations for the next business day were announced around 4:30 pm and provided the time, security sector/type, and planned purchase amounts. By mid-April 2020, operation schedules were provided for the

CHART 15
Open Market Purchases of Treasury Securities

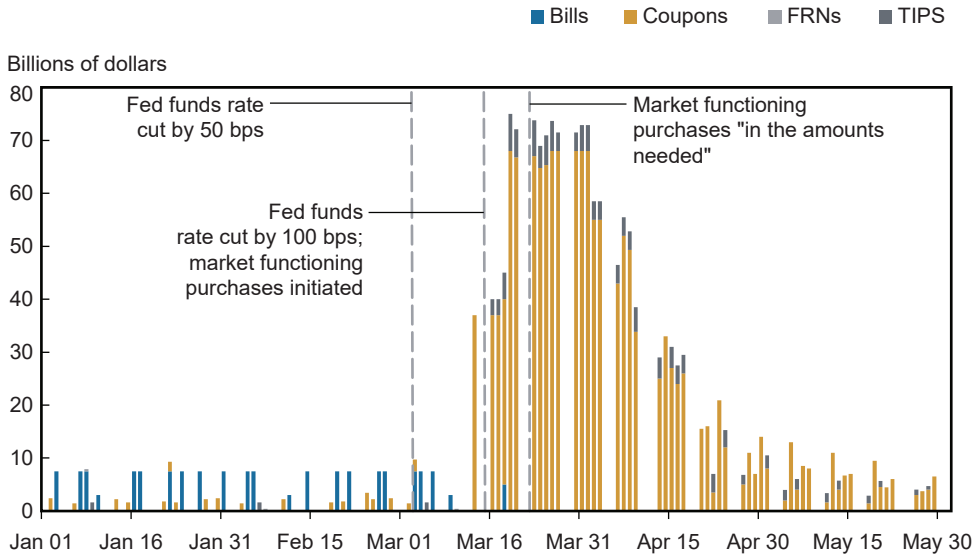

Source: Authors' calculations, based on data from the Federal Reserve Bank of New York.

Notes: The chart plots open market purchases of U.S. Treasury securities by the Federal Reserve by day from January 1 to May 31, 2020. Even before the March 15 FOMC announcement of purchases to promote market functioning, the Fed was engaging in reserve management purchases of Treasury securities and reinvesting principal payments received from its holdings of agency debt and agency mortgage-backed securities. Moreover, the Fed announced on March 13 that it was bringing forward these purchases “to address highly unusual disruptions in the market for Treasury securities.” This explains why there were some purchases in early March and a large quantity of purchases on March 13, before the March 15 announcement of purchases to promote market functioning. Purchases are measured in billions of dollars par.

coming week and by mid-June 2020 for the coming half month. MBS operation schedules were provided for the coming week between late March and early June 2020, and otherwise for the coming half month, although the schedules were updated on a daily or near-daily basis from mid-March to mid-April. Treasury operations occurred in one of five maturity buckets for nominal coupons (0-2.25 years, 2.25-4.5 years, 4.5-7 years, 7-10 years, and 20-30 years), or one of two for TIPS (1-7.5 years and 7.5-30 years).¹⁷ Agency MBS operations occurred in one of three security types: 15-year UMBS, 30-year UMBS, and 30-year Ginnie Mae MBS.

Purchase amounts started at roughly \$40 billion per day in Treasury securities, but quickly ramped up to about \$70 billion per day, where they remained for two weeks between March 19 and April 1 (Chart 15). Agency MBS purchase amounts started at about \$5 billion per day and quickly topped out at \$41 billion on March 27 (Chart 16). As market functioning improved, daily purchase amounts declined, stabilizing at a pace of around \$80 billion per month (roughly \$4 billion per day, on average) for Treasury securities and about \$40 billion for agency MBS, net of reinvestments (or roughly \$2 billion per day, on average).

Variation in daily purchase amounts is explained by both variation in operation frequency as well as operation size. The number of Treasury operations per day topped out at seven in

CHART 16

Open Market Purchases of Agency MBS

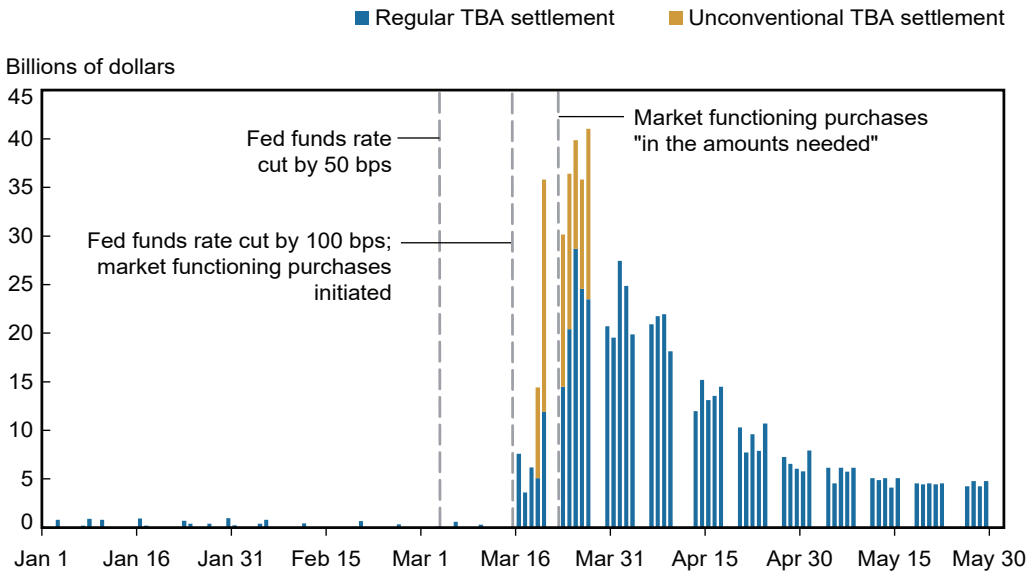

Source: Authors' calculations, based on data from the Federal Reserve Bank of New York.

Notes: The chart plots open market purchases of agency mortgage-backed securities (MBS) by the Federal Reserve by day from January 1 to May 31, 2020, distinguishing between purchases with a regular TBA settlement date and those with a shorter, unconventional TBA settlement date.

late March and early April, but varied between zero and two for every day in 2020 after April 17. The average amount purchased per operation was just over \$10 billion in late March (defined as the last five trading days of the month), about \$6 billion in late April, and roughly \$3 billion in late May. Across all Treasury operations in 2020, the average amount purchased was \$6.5 billion (Table 1).

For agency MBS, the number of operations per day topped out at six in late March and early April, and was then two to three on almost every day in 2020 after April 17. The amount purchased per operation averaged nearly \$7 billion in late March, just over \$3 billion in late April, and just over \$2 billion in late May. Across all MBS operations in 2020, the average purchase amount was \$2.7 billion (Table 1). Agency CMBS operations were much less frequent, with two operations on April 9 and at most one any other day. Agency CMBS operation sizes maxed out at \$2.0 billion on April 7.

Amounts submitted in the operations between March 13, 2020, and the end of the year averaged about 2½ times the planned purchase amounts for both Treasury securities and agency MBS and somewhat less for agency CMBS (Table 1). Such offer-to-cover ratios were less than 1 (that is, amounts submitted were less than planned purchase amounts) for seven of the 330 Treasury operations, twenty of the 539 agency MBS operations, and seventeen of the forty-six CMBS operations. All of these low coverage Treasury and agency MBS operations occurred between March 20 and April 9.

TABLE 1

Descriptive Statistics on Market Functioning Purchase Operations in 2020

	Treasury Securities	Agency MBS	Agency CMBS
Number of operations	330	539	46
Planned purchase amount	6.65 (1.00, 25.00)	3.02 (0.67, 20.00)	0.55 (0.25, 2.00)
Amount submitted	15.07 (1.42, 56.82)	6.12 (1.54, 27.17)	1.08 (0.04, 6.48)
Amount accepted	6.51 (0.70, 25.00)	2.71 (0.67, 17.55)	0.22 (0.00, 2.03)
Offer-to-cover	2.34 (0.59, 5.75)	2.45 (0.26, 5.50)	1.69 (0.07, 5.62)

Source: Authors' calculations, based on data from the Federal Reserve Bank of New York.

Notes: The table reports operation statistics for Federal Reserve purchases of Treasury securities, agency mortgage-backed securities (MBS), and agency commercial mortgage-backed securities (CMBS) between March 13, 2020, and December 31, 2020 (excluding small-value exercises). Offer-to-cover is the ratio of amount submitted to the planned purchase amount for a given operation. For all variables except the number of operations, averages are reported with minimums and maximums in parentheses. Planned purchase amount, amount submitted, and amount accepted are in billions of dollars, par value.

2.3 Novel Aspects of the Purchases

The motivation for the market functioning purchases led to several innovations in how they were conducted, aside from their speed and scale. In particular, the variation in the pace of purchases and the distribution of purchases across sectors, discussed above, were based on both observable measures of market functioning as well as judgement (Logan 2020b). Varying market conditions led to further innovations in the particular securities purchased and in the settlement timing of the purchases.

Measures of market functioning

The metrics used to inform the market functioning purchases fell into four categories (Logan 2020b; Federal Reserve Bank of New York 2021, p. 25). The first included direct measures of liquidity, such as bid-ask spreads, price impact coefficients, and market depth, which reflect market participants' ability to transact at reasonable costs. The second included direct measures of relative value, such as the Treasury cash-futures basis, on-the-run/off-the-run spreads, and MBS-Treasury yield spreads, which indicate whether closely related securities are priced similarly, and whether arbitrage between markets is working well.

The remaining categories contained indirect metrics that may reveal forces that can lead to breakdowns of liquidity and efficient pricing. The third category thus included measures of trading pressure, including data on customer-initiated transactions, holdings of foreign official accounts, and dealer inventories, which can suggest imbalances between liquidity demand and liquidity supply. The last category included the results of

the Desk's open market operations, such as offer-to-cover ratios, which can provide information market participants' desire to sell securities or other challenges to market functioning.

Short settlement MBS purchases

Another innovation in the 2020 market functioning purchases was the adjustment of settlement timing for some agency MBS operations in order to more quickly influence market conditions (Logan 2020b). Historically, the Fed followed the TBA schedule for its purchases, with a monthly settlement date, usually in the middle of the month. A potential downside of the TBA schedule is that the Fed and its primary dealer counterparties need to wait until the next monthly settlement date to exchange cash for securities. During the March 2020 dash for cash, many sellers of securities could not wait so long (Chen et al. 2020).¹⁸ Evidence of these cash needs is the reduced pay-up at the time, as selling pressure disproportionately went to the SP market, driving down SP prices relative to TBA prices (Chart 9).

To address the surge in demand for cash (Federal Reserve Bank of New York 2021), the Fed made agency MBS purchases that settled within two to three business days between March 19 and March 27 (Chart 16). With these purchases, dealers received cash faster for their securities and could use the freed balance sheet space to absorb more sales from customers. Comparing prices from the short settlement trades and the conventional trades for the same security on the same trading date, we see that dealers were willing to accept large discounts for short settlement trades (Chart 17), suggesting both large price dislocations and strong demand for these innovative short settlement offerings (also see Chen et al. 2020).

CMBS purchases

Another innovative feature of the market functioning purchases is that for the first time the Fed purchased agency CMBS. Agency CMBS are securitizations of loans for commercial real estate, primarily multifamily residential properties, such as apartment buildings. As with single-family mortgages, Fannie Mae, Freddie Mac, and Ginnie Mae package these loans into securities and guarantee principal and interest payments. Broker dealers facilitate sales of the securities to investors. As of July 2020, agency CMBS outstanding totaled around \$750 billion, accounting for 47 percent of the \$1.6 trillion in total multifamily mortgage debt outstanding (Park, Gouny, and Liu 2020).

In March 2020, conditions in the agency CMBS market became severely disrupted amidst broad financial market stress and concern about the effects of the pandemic on commercial real estate in particular. New issuance of agency CMBS stalled, threatening to reduce credit availability in the multifamily housing sector. The market functioning purchases for agency CMBS began on March 27, following the FOMC's direction to the Desk on March 23. The purchases relied on a different execution method and a broader set of counterparties than purchases of Treasury securities and other agency MBS, reflecting the novelty of the Fed's purchases and the unique aspects of the market.¹⁹ While purchases of agency CMBS in 2020 were relatively small, about \$10 billion in total or under 2 percent of the total outstanding, both primary market issuance and secondary market metrics largely returned to normal by April 2020.

CHART 17

Short Settlement Price Discounts for Agency MBS Purchases

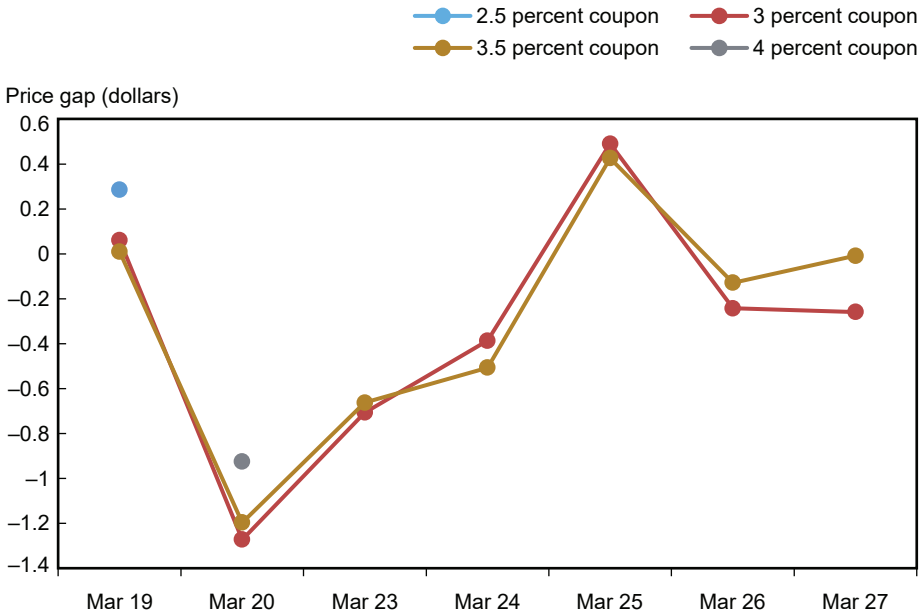

Source: Authors' calculations, based on data from the Federal Reserve Bank of New York.

Notes: The chart plots the average price gap between Federal Reserve purchases for short settlement and Federal Reserve purchases for regular settlement in the same UMBS coupon by day and coupon. Negative (positive) numbers imply that prices for short settlement are lower (higher) than those for regular settlement. Price differences are per \$100 par.

Cheapest-to-deliver Treasury purchases

Another departure from past purchase programs is that the Treasury operations between March 13, 2020, and April 17, 2020, included securities that were cheapest-to-deliver (CTD) into futures contracts. This was done to support smooth market functioning in these securities (and off-the-run securities more broadly) amid heightened volatility and demand for liquidity (FAQs: Treasury Purchases, April 17, 2020). Dislocations had arisen in the relative value relationship between the futures contracts and the CTD securities. The dislocations reflected the wider dash for cash as well as large-scale liquidations of levered relative value positions, which reportedly contributed to the increase in dealer positions (Schripf, Shin, and Sushko 2020; Barth and Kahn 2021).

2.4 Challenges, Limitations, and Drawbacks of Market Functioning Purchases

While there were sound reasons to think that the Fed's market functioning purchases would achieve their purpose, such purchases do not come without challenges, limitations, and drawbacks.

First, as with most policy responses, market functioning purchases require proper diagnosis of the problem. That is, in 2020, the problem that positions were building up on dealer balance sheets due to customer selling and that central bank purchases could help restore balance to the market and enable dealers to fulfill their intermediation role. If the disruptions had arisen for other reasons, or if dealers were not willing to intermediate flows between customers and the central bank, then such purchases could have been counterproductive and exacerbated market dysfunction.

A related challenge is that it may be difficult for a central bank to calibrate the quantity of securities to be purchased. As an example, the Fed has access to timely information on dealers' trades with customers via Trade Reporting and Compliance Engine (TRACE) data of the Financial Industry Regulatory Authority (FINRA), but the data are incomplete and do not reflect trades that customers may have wanted to execute but could not.²⁰ The data also do not reveal the quantity of customer flows that dealers can absorb themselves without adversely affecting market functioning. Moreover, market functioning has multiple dimensions, some of which can be difficult to measure. Proper calibration arises with any policy response but is particularly difficult in an uncertain and fast-changing environment.

A possible limitation of market functioning purchases is the reliance on primary dealer counterparties. There are important reasons the Fed and other central banks have primary dealer counterparties with various requirements and expectations. In March 2020, however, as customer flows overwhelmed dealers' capacity to intermediate them (Duffie 2020), there may have been advantages to transacting directly with customers and additional dealers. Some of the proposals to promote a more resilient market structure suggest that Fed liquidity provision be made accessible to a broader range of counterparties (for example, Liang and Parkinson 2020; Brookings 2021; and Group of Thirty 2021), albeit for repos and not outright transactions.

A potential drawback of market functioning purchases is that they have an expansionary effect on the economy by lowering yields (as with the LSAPS, as discussed in Gagnon et al. 2011). That is, while the market functioning purchases were conducted for somewhat different reasons than the LSAPs of the preceding years, they could still be expected to have similar effects. During the pandemic, this ancillary effect was a positive one given the risks to the economy. Moreover, the rationale for the purchases evolved over time to be closer to that of the earlier LSAPs as discussed below. However, it is possible that there could be a future episode of market dysfunction in which the expansionary effect of such purchases would be contrary to the desired monetary policy stance (Hauser 2021 makes a similar point).

Another potential drawback of market functioning purchases is that they increase the size of the central bank's balance sheet. The Fed's assets grew from \$4.3 trillion on March 10, 2020, to \$7.4 trillion on December 30, 2020, with 93 percent of this increase explained by the Fed's increased holdings of Treasury securities and agency MBS. A large central bank balance sheet, excessive asset purchases, and/or substantial government security purchases in particular are sometimes viewed as overly intrusive in financial markets, excessively risky, and/or a precursor to excessive inflation.²¹ Moreover, shrinking the balance sheet takes time and poses communication challenges.

Lastly, a possible drawback of any central bank action during a crisis, including the market functioning purchases, is that it may introduce moral hazard. That is, market participants may lack sufficient incentive to protect themselves against the risks associated with their actions, or may take greater risks, if they don't bear the full consequences. The Financial Stability Board (2020) thus argues that the aggressive central bank actions to restore market

functioning in 2020 “could lead to moral hazard issues in the future, to the extent that markets do not fully internalise their own liquidity risk in anticipation of future central bank interventions in times of stress.” Kovner and Martin (2020), in contrast, suggest that moral hazard concerns may be mitigated because the pandemic was not expected, so the interventions did not reward firms that took excessive risk, and because systemic shocks are rare, so official sector support in response to them is unlikely to have much effect on incentives.

3. THE PURCHASES' EFFECTS AND THEIR EVOLUTION

3.1 Effects of the Purchases

We assess the effects of the Fed's purchases by relating their initiation and scaling up to the evolution of various market functioning measures. We focus on market functioning given the policy's stated aim, although other effects are also important (Vissing-Jorgensen [2021], for example, assesses the effects on yields). To be sure, attributing causality to the purchases is challenging. The purchases occurred amidst the rapidly evolving pandemic and numerous resulting policy actions, both fiscal and monetary. Moreover, market functioning has multiple aspects, some of which are hard to quantify. In addition, market functioning metrics are not necessarily forward looking in the same way as asset prices, so that a credible announcement to support market functioning could reasonably have delayed effects (for example, because the announcement breeds uncertainty about asset values that initially worsens functioning).

The evidence is supportive of the purchases being effective at promoting market functioning. Many Treasury market liquidity measures as well as Treasury volatility, reached their nadir on Friday, March 13 (Charts 1, 3, 4, and 5). The Fed acquired significant Treasury securities that day as it moved forward its reserve management and other purchases, but the FOMC's announcement of market functioning purchases (and a cut in the fed funds rate to the zero lower bound) did not come until Sunday, March 15. Liquidity conditions improved notably the next day from the preceding Friday, with volatility declining.

The next notable improvement in Treasury market functioning occurred Friday, March 20, following the ramping up of Treasury purchases the preceding day to \$68 billion. That day saw a narrowing of bid-ask spreads, increased market depth, lower price impact, and reduced volatility. The two- and five-year on-the-run/off-the-run spreads also declined sharply (and the ten-year spread modestly) that day (Chart 8). Treasury yields, which had continued increasing after the initiation of market functioning purchases, declined modestly on March 19 and more sharply on March 20, which Vissing-Jorgensen (2021) attributes to the higher pace of purchases.

Despite some improvements, Treasury market functioning remained highly strained through March 23, when the Fed dropped explicit quantity limits on its total purchases. Liquidity improved notably the next day and volatility plunged. Liquidity continued to improve steadily for the next couple weeks, with volatility declining, even as the Fed pared back its purchases from their highest levels. By the week of April 6-10, some liquidity metrics were close to normal, with bid-ask spreads for recently issued notes and bonds commensurate with usual levels.²² Other metrics suggested continued illiquidity relative to the levels of early 2020, but liquidity continued to improve over subsequent weeks and months.²³

Agency MBS liquidity metrics broadly followed a similar pattern. Bid-ask spreads and price impact for 3 percent UMBS deteriorated on March 12, before slightly improving after the Treasury purchases on March 13 (Charts 6 and 7). However, liquidity measures further deteriorated in the second half of the week of March 15 and reached their peaks on March 19. After the Fed committed to market functioning purchases “in the amounts needed” on March 23, market conditions gradually improved. Bid-ask spreads and price impact improved notably by the week of April 6-10, followed by further improvements in the weeks and months that followed.

Price dislocations in the agency MBS market largely moved in line with the liquidity measures. MBS-Treasury basis volatility and pay-up reached their most extreme levels between the first market functioning purchase announcement on March 15 and the second on March 23, but returned closer to normal after March 23 (Charts 9 and 10). Short settlement discounts (Chart 17), which we interpret as a measure of dealer balance sheet costs, narrowed on March 23, but remained large. The discount continued to narrow over the next couple days and was close to 0 on March 26 and March 27, which may explain the Fed’s return to the usual TBA settlement schedule for its purchases the following Monday.

3.2 From Supporting to Sustaining and Beyond

As market conditions improved, Fed purchases were quickly scaled back, dropping from a daily average of \$104 billion in late March to \$18 billion in late April and \$9.5 billion in late May. By late May, purchases bottomed out at a level that would persist through the rest of 2020 (Chart 18) and into 2021, and at a level commensurate with that of the earlier LSAP programs. This occurred as the FOMC’s commitment to asset purchases “in the amounts needed” remained, with the April FOMC statement using the same wording to characterize the purchases as the March 23 statement that preceded it.

By the time of the June 2020 FOMC meeting, the pace of purchases had declined to roughly \$80 billion per month in Treasury securities and about \$40 billion per month in agency MBS, net of reinvestments. The FOMC announced in June (and again in July) that it would increase its holdings of Treasury securities and agency MBS “at least at the current pace to sustain smooth market functioning, thereby fostering effective transmission of monetary policy to broader financial conditions” (Board of Governors 2020c). The change from “supporting” to “sustaining” thus acknowledged the improvement in market functioning that had already occurred. Moreover, the new guidance about purchase quantities was accompanied by monthly purchase amounts (that were consistent with the pace of purchases at the time) and semi-monthly purchase schedules (Logan 2020b).

After the September and November 2020 meetings, the FOMC announced that it would increase its holdings of Treasury securities and agency MBS “at least at the current pace to sustain smooth market functioning and help foster accommodative financial conditions” (Board of Governors 2020d). The new guidance thus acknowledged what Chair Powell had been saying for some time—that the purchases had a broader benefit than just promoting market functioning.²⁴

The ongoing pace of asset purchases was formalized in the FOMC’s December 2020 meeting statement in which it directed the New York Fed’s Trading Desk to increase its

CHART 18
Open Market Purchases by Week (Average Daily)

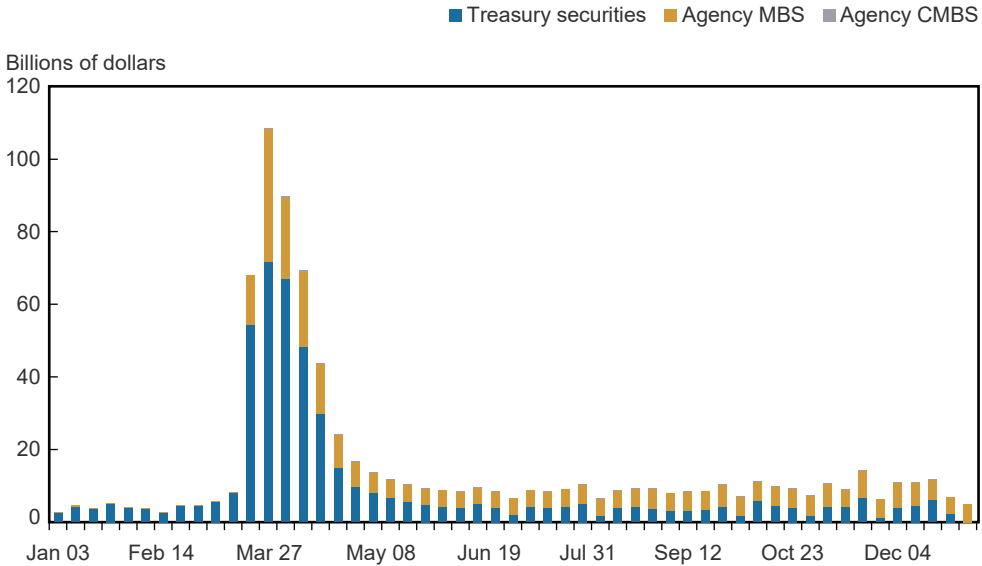

Source: Authors' calculations, based on data from the Federal Reserve Bank of New York.

Notes: The chart plots average daily open market purchases of U.S. Treasury securities, agency mortgage-backed securities (MBS), and agency commercial mortgage-backed securities (CMBS) by the Federal Reserve by week in 2020. Agency CMBS purchases are hard to discern in the chart because they were small relative to Treasury and agency MBS purchases. Purchases are measured in billions of dollars per week.

holdings of Treasury securities by at least \$80 billion per month and of agency MBS by at least \$40 billion per month “until substantial further progress has been made toward the Committee’s maximum employment and price stability goals,” while noting that “these asset purchases help foster smooth market functioning and accommodative financial conditions” (Board of Governors, 2020e). Similar wording appeared in FOMC statements through September 2021.

In light of the economy’s further progress toward the committee’s goals, the FOMC decided at its November 2021 meeting that it would begin reducing the monthly pace of its net asset purchases, by \$10 billion for Treasury securities and \$5 billion for agency MBS. It then decided at its December 2021 meeting to reduce the monthly pace of its net asset purchases by \$20 billion for Treasury securities and \$10 billion for agency MBS given inflation developments and further improvement in the labor market.

4. CONCLUSION

The COVID-19 pandemic had extraordinary effects on U.S. financial markets whereby investors sought to sell their safest and most liquid securities to raise cash. The selling overwhelmed dealers’ capacity to absorb the flows and contributed to the worst market disruptions since the

global financial crisis, amidst the worst recession since World War II. The Federal Reserve took steps to address the disruptions, including the initiation of purchases of Treasury securities and agency MBS to promote smooth functioning of these critical markets. The purchases seem to have been effective with market conditions rapidly improving, and the asset purchases were scaled back accordingly.

The market functioning purchases were novel with respect to their speed, scale, and innovativeness. In terms of speed and scale, the purchases quickly reached over \$100 billion per day, dwarfing the pace of asset purchases seen with the LSAPs during and after the global financial crisis. In terms of innovativeness, the Fed varied the pace and distribution of purchases based on observable measures of market functioning, reflecting the particular motivation for the purchases. It also engaged in “short settlement” MBS operations, through which the trades settled much sooner than market convention prescribed, allowing dealers to obtain cash for their MBS sales much more speedily than is typical. The Fed also for the first time purchased agency CMBS to promote the smooth functioning of this important market.

At the same time, the market functioning purchases were not unique, relying on familiar tools, specific precedent, and general principles. First, the Fed relied on a tool—open market trading in Treasury securities and agency MBS—that it commonly uses (albeit more recently in the case of agency MBS) in the implementation of monetary policy. Moreover, the Fed purchased such securities in large quantities during and after the global financial crisis (albeit for different purposes) and had purchased Treasury securities to support market functioning in episodes before that. More generally, the purchases provided liquidity, which is a classic central bank function, thereby promoting financial stability, a purpose for which the Fed was created.

APPENDIX: OVERVIEW OF THE U.S. AGENCY MBS MARKET

A mortgage-backed security is an asset-backed security that is secured by a pool of mortgage loans in which principal and interest payments are passed through to investors on a pro rata basis. MBS that are guaranteed by a government agency (Ginnie Mae) or a government sponsored enterprise (Fannie Mae and Freddie Mac) are known as agency MBS. While most agency MBS are backed by mortgages for single-family homes, agency CMBS are backed by loans for commercial real estate, primarily multifamily residential properties, such as apartment buildings.

The agency MBS market is highly liquid, second only to the U.S. Treasury market domestically (Gao, Schultz, and Song 2017; Vickery and Wright 2013). The market had about \$9.8 trillion in securities outstanding at the end of 2020, with an average daily trading volume in 2020 of around \$290 billion.²⁵ In contrast, the larger U.S. corporate market, with about \$10.6 trillion in securities outstanding, had an average daily trading volume in 2020 of around \$39 billion.

The significant transaction volume, depth, and liquidity of the agency MBS market can largely be attributed to the existence of the to-be-announced (TBA) MBS trading convention. In a TBA trade, the buyer and seller agree on the type of security (that is, agency, program, coupon, face value, price, and settlement date), but the specific underlying pool is not known until close to the settlement day. While the agency MBS market consists of thousands of heterogeneous MBS pools backed by millions of individual mortgages, the TBA trading convention allows trading to concentrate in a small number of liquid forward contracts. TBA trading thus accounts for more than 90 percent of agency MBS trading volume (Vickery and Wright 2013). The remaining share of volume is accounted for by specified pool (SP) trades, in which the particular security exchanged is agreed to at the time of the trade, with settlement occurring as soon as the same day.

MBS issued by Fannie Mae and Freddie Mac have historically traded in separate TBA contracts. As a result of this segmentation, market liquidity endogenously concentrated in Fannie Mae MBS, with higher trading volume and lower transaction costs than Freddie Mac MBS with similar characteristics (Liu, Song, and Vickery 2021). To improve liquidity for the overall MBS market, the regulator of Fannie Mae and Freddie Mac, the Federal Housing Finance Agency, effectively combined trading of Fannie Mae TBA contracts with Freddie Mac TBA contracts into Uniform MBS (UMBS) contracts in June 2019. Since then, sellers in UMBS TBA contracts can deliver either Fannie Mae UMBS or Freddie Mac UMBS to settle trades.

NOTES

Acknowledgments: The authors thank Richard Crump (referee), Frank Keane, Anna Kovner, Kyle Lee, Brett Rose, Nicholas Steele, Brandon Taylor, and Jennifer Wolgemuth for helpful comments, and Claire Nelson, Dean Parker, and Francisco Ruela for excellent research assistance.

¹ Note that the Federal Reserve is composed of many parts, each of which plays a different role. The FOMC authorizes and directs the Federal Reserve Bank of New York (New York Fed) to undertake various open market operations usually for the System Open Market Account. The FOMC's directives are typically addressed to the Open Market Trading Desk, a unit within the New York Fed's Markets Group. The FOMC also establishes the target range for the federal (fed) funds rate. The Board of Governors of the Federal Reserve System (the Board) adopts regulations, authorizes Reserve Bank lending facilities under Section 13(3) of the Federal Reserve Act with the approval of the Secretary of the Treasury, and sets the rates on interest on reserves. Reserve Bank Boards of Directors set the primary and secondary rate for discount window lending, which are subject to review and determination by the Board. For ease of reference, this paper often uses the term "the Fed" to describe the actor, even though one or more different individual constituent parts of the Fed may be acting.

² The appendix provides an overview of the agency MBS market, including a description of to-be-announced (TBA) trading and UMBS.

³ See "COVID-19 – China," World Health Organization Disease Outbreak News, January 5, 2020, "First Patient With Wuhan Coronavirus Is Identified in the U.S.," *New York Times*, January 21, 2020, and "C.D.C. Confirms First Possible Community Transmission of Coronavirus in U.S.," *New York Times*, February 26, 2020.

⁴ Bid-ask spreads for off-the-run (seasoned) issues widened even more in March 2020, as shown in Logan (2020a) and Clarida, Duygan-Bump, and Scotti (2021).

⁵ Treasury bid-ask spreads are measured directly using quoted prices from a central limit order book from the interdealer market and Treasury price impact is calculated using high frequency measures of order flow and bid-ask midpoint changes from the same market. In contrast, MBS bid-ask spreads and price impact are inferred from transaction prices over the full course of a trading day.

⁶ Treasury bill yields were steadier in early 2020, especially at the short end, declined sharply over the February 26 to March 9 period, and then declined further between March 9 and March 18 when note and bond yields were rising.

⁷ Our characterization of volatility is based on the realized volatility measure plotted in Chart 1. Implied volatility, as measured by the ICE BofAML MOVE Index, exhibits a similar pattern, rising sharply March 6, remaining unusually high between March 9 and March 23, and dropping sharply March 24, albeit peaking on March 9.

⁸ Again, these metrics are for the on-the-run notes and bonds and based on data from the interdealer market. Bid-ask spreads for off-the-run securities peaked a few days later, as shown in Clarida, Duygan-Bump, and Scotti (2021).

⁹ Primary dealers are trading counterparties of the New York Fed in its implementation of monetary policy. They are also expected to make markets for the New York Fed on behalf of its official accountholders as needed, and to bid on a pro-rata basis in all Treasury auctions at reasonably competitive prices. The expectations and requirements of primary dealers, along with the current list, are available on the Markets Group's Primary Dealers page. Note that primary dealers' bill holdings declined markedly between February 26 and March 25, which, combined with the sharp decline in bill yields over this period, suggests that some customers sought to convert note and bond holdings into bill holdings and not just cash.

¹⁰ Such behavior differs markedly from the October 15, 2014, flash rally, when PTFs generally increased their share of trading activity (U.S. Department of the Treasury et al., Joint Staff Report, 2015). One difference between the episodes was the sustained period of high volatility in March 2020. Note that PTFs increased their level of activity sharply in late February and early March 2020 as overall trading volume surged, and then decreased both their level and share of activity in mid-March.

NOTES (CONTINUED)

¹¹ The Desk's statements announcing changes to the operating policies for conducting open market operations are listed on the Markets Group's Statements and Operating Policies page. As noted in the statements, these changes were consistent with the FOMC's directive to the Desk.

¹² As discussed elsewhere in this paper, reserve management purchases of Treasury bills were being conducted at a rate of \$60 billion per month to maintain ample reserve balances. Moreover, the principal payments from agency debt securities (that is, direct housing agency obligations) and agency mortgage-backed securities, up to \$20 billion per month, were being reinvested in Treasury securities, and principal payments in excess of \$20 billion per month were being reinvested in agency MBS.

¹³ Note that our analysis and what we call market functioning purchases are limited to open market purchases of securities by the System Open Market Account, authorized under Section 14 of the Federal Reserve Act, and hence exclude securities acquired by the facilities using the Fed's emergency lending powers authorized under Section 13(3) of the Act.

¹⁴ Permanent open market operations involve outright purchases or sales of securities, whereas "temporary" open market operations involve short-term repurchase and reverse repurchase agreements. Note that some non-primary dealers were approved counterparties for the Fed's agency CMBS purchases, as explained later.

¹⁵ The Desk conducts agency MBS dollar roll transactions via Tradeweb, a commercial trading platform. Such transactions are executed through a competitive bidding process in line with standard market practices. Agency CMBS purchases were operationalized by Blackrock Financial Markets Advisory. See the Markets Group's FAQs: Treasury Purchases and FAQs: Agency MBS Purchases for additional information on the purchases.

¹⁶ The Desk conducted one operation in Treasury bills at the outset of market functioning purchases. There were no purchases of Treasury floating rate notes. Planned purchase amounts and schedules for Treasury securities are available on the Markets Group's Treasury Securities Operational Details and Treasury Security Operations pages. Analogous information for agency MBS purchases is available on the Tentative Outright Agency Mortgage-Backed Securities Operation Schedule and Agency Mortgage-Backed Securities Operations pages.

¹⁷ The maturity buckets differed before the market functioning purchases started in March 2020 and were expanded to six for nominal coupons in May 2021.

¹⁸ Typically, the costs associated with monthly settlement schedule are minimal. Interest rate risk is transferred with the execution of a trade. The exchange of securities for cash does not occur until later, but the seller of securities may not need the cash or it may be able to cheaply and easily borrow funds against the sold securities between the trade and settlement dates. It follows that the logistical benefits of monthly settlement usually exceed the costs and that the Fed's purchases of agency MBS typically follow the monthly settlement schedule.

¹⁹ The New York Fed retained BlackRock Financial Markets Advisory as a third-party vendor to operationalize agency CMBS purchases and transact with approved counterparties on behalf of the SOMA. Approved counterparties included a subset of the primary dealers as well as other dealers who applied for and received approval. On September 4, 2020 the New York Fed announced an expansion of approved counterparties in order to broaden access to the operations and increase the New York Fed's operational capacity and reach into the agency CMBS market. See FAQs: Agency Commercial Mortgage-Backed Securities for additional details.

²⁰ While dealers report their trades to TRACE, entities that are not FINRA-member dealers, such as banks, do not report their trades. In October 2021, the Fed adopted a proposal to implement reporting requirements on trading in Treasury securities, agency debt securities, and agency MBS for certain depository institutions, thereby expanding the coverage of reporting.

²¹ See, for example, Norbert Michel, "It's Time for the Fed to Shrink its Balance Sheet," *Forbes*, May 12, 2017, and Michael S. Derby, "Derby's Take: Powell Says Fed Is Not Monetizing Treasury Debt Surge," *Wall Street Journal*, June 17, 2020.

NOTES (CONTINUED)

²² Bid-ask spreads remained unusually wide for an extended period for off-the-run securities, as shown in Logan (2020a) and Clarida, Duygan-Bump, and Scotti (2021).

²³ Interestingly, gross customer sales of off-the-run notes and bonds peaked on March 23, when the Fed dropped explicit quantity limits on its total purchases (Chart 11). Nonetheless, sales remained extremely high into early April, and higher-than-usual through mid-April.

²⁴ See, for example, the transcripts of Chair Powell's press conferences after the April, June, and July 2020 FOMC meetings.

²⁵ Source: SIFMA U.S. Fixed Income Statistics.

REFERENCES

- Adrian, T., M. J. Fleming, J. E. Goldberg, M. Lewis, F. M. Natalucci, and J. J. Wu.* 2013. "Dealer Balance Sheet Capacity and Market Liquidity during the 2013 Selloff in Fixed-Income Markets." Federal Reserve Bank of New York LIBERTY STREET ECONOMICS, April 17.
- Amihud, Y.* 2002. "Illiquidity and Stock Returns: Cross-Section and Time-Series Effects." JOURNAL OF FINANCIAL MARKETS 5, 31–56.
- Barth, D., and R. J. Kahn.* 2021. "Hedge Funds and the Treasury Cash-Futures Disconnect." OFR Working Paper, No. 21-01, April 1.
- Board of Governors of the Federal Reserve System.* 2008. "Federal Reserve Announces It Will Initiate a Program to Purchase the Direct Obligations of Housing-Related Government-Sponsored Enterprises and Mortgage-Backed Securities Backed by Fannie Mae, Freddie Mac, and Ginnie Mae." Press release, November 25.
- Board of Governors of the Federal Reserve System.* 2009. "FOMC Statement." Press release, March 18.
- Board of Governors of the Federal Reserve System.* 2020a. "Federal Reserve Issues FOMC Statement." Press release, March 15.
- Board of Governors of the Federal Reserve System.* 2020b. "Federal Reserve Issues FOMC Statement." Press release, March 23.
- Board of Governors of the Federal Reserve System.* 2020c. "Federal Reserve Issues FOMC Statement." Press release, June 10.
- Board of Governors of the Federal Reserve System.* 2020d. "Federal Reserve Issues FOMC Statement." Press release, September 16.
- Board of Governors of the Federal Reserve System.* 2020e. "Federal Reserve Issues FOMC Statement." Press release, December 16.
- Brookings Institution.* 2021. "Report of the Task Force on Financial Stability." June.
- Chen, J., H. Liu, D. Rubio, A. Sarkar, and Z. Song.* 2020. "MBS Market Dysfunctions in the Time of COVID-19." Federal Reserve Bank of New York LIBERTY STREET ECONOMICS, July 17.
- Clarida, R. H., B. Duygan-Bump, and C. Scotti.* 2021. "The COVID-19 Crisis and the Federal Reserve's Policy Response." Board of Governors of the Federal Reserve System, FINANCE AND ECONOMICS DISCUSSION SERIES 2021-035.

REFERENCES (CONTINUED)

- Duffie, D.* 2020. "Still the World's Safe Haven? Redesigning the U.S. Treasury Market after the COVID-19 Crisis." Brookings Institution, Hutchins Center Working Paper 62, May.
- Federal Reserve Bank of New York.* 2021. "Open Market Operations during 2020." May.
- Financial Stability Board.* 2020. "Holistic Review of the March Market Turmoil." November 17.
- Fleming, M.* 2020. "Treasury Market Liquidity and the Federal Reserve during the COVID-19 Pandemic." Federal Reserve Bank of New York LIBERTY STREET ECONOMICS, May 29.
- Fleming, M., and F. Ruela.* 2020. "Treasury Market Liquidity during the COVID-19 Crisis." Federal Reserve Bank of New York LIBERTY STREET ECONOMICS, April 17.
- Fleming, M., A. Sarkar, and P. Van Tassel.* 2020. "The COVID-19 Pandemic and the Fed's Response." Federal Reserve Bank of New York LIBERTY STREET ECONOMICS, April 15.
- Fuster, A., S. H. Lo, and P. S. Willen.* 2017. "The Time-Varying Price of Financial Intermediation in the Mortgage Market." Federal Reserve Bank of New York STAFF REPORTS, no. 805, August.
- Gagnon, J., M. Raskin, J. Remache, and B. Sack.* 2011. "Large-Scale Asset Purchases by the Federal Reserve: Did They Work?" Federal Reserve Bank of New York ECONOMIC POLICY REVIEW 17, no. 1: 41-59.
- Gao, P., P. Schultz, and Z. Song.* 2017. "Liquidity in a Market for Unique Assets: Specified Pool and To-Be-Announced Trading in the Mortgage-Backed Securities Market." JOURNAL OF FINANCE 72, no. 3: 1119-70.
- Garbade, K. D., and F. M. Keane.* 2020. "Market Function Purchases by the Federal Reserve." Federal Reserve Bank of New York LIBERTY STREET ECONOMICS, August 20.
- Group of Thirty.* 2021. "U.S. Treasury Markets: Steps Toward Increased Resilience." July.
- Gurkaynak, R. S., B. Sack, and J. H. Wright.* 2007. "The U.S. Treasury Yield Curve: 1961 to the Present." JOURNAL OF MONETARY ECONOMICS 54: 2291-304.
- Harkrader, J. C., and M. Puglia.* 2020. "Principal Trading Firm Activity in Treasury Cash Markets." Board of Governors of the Federal Reserve System FEDS NOTES, August 4.
- Hauser, A.* 2021. "From Lender of Last Resort to Market Maker of Last Resort via the Dash for Cash: Why Central Banks Need New Tools for Dealing with Market Dysfunction." Speech given at Thomson Reuters Newsmaker, January 7.

REFERENCES (CONTINUED)

- Kovner, A., and A. Martin.* 2020. "The Official Sector's Response to the Coronavirus Pandemic and Moral Hazard." Federal Reserve Bank of New York LIBERTY STREET ECONOMICS, September 24.
- Liang, N., and P. Parkinson.* 2020. "Enhancing Liquidity of the U.S. Treasury Market Under Stress." Brookings Institution, Hutchins Center Working Paper 72.
- Liu, H., Z. Song, and J. Vickery.* 2021. "Defragmenting Markets: Evidence from Agency MBS." Federal Reserve Bank of New York STAFF REPORTS 965, May.
- Logan, L.* 2020a. "Treasury Market Liquidity and Early Lessons from the Pandemic Shock." Remarks at Brookings-Chicago Booth Task Force on Financial Stability Meeting, October 23.
- Logan, L.* 2020b. "The Federal Reserve's Market Functioning Purchases: From Supporting to Sustaining." Remarks at SIFMA Webinar, July 15.
- Ma, Y., K. Xiao, and Y. Zeng.* 2020. "Mutual Fund Liquidity Transformation and Reverse Flight to Liquidity." Jacobs Levy Equity Management Center for Quantitative Financial Research Paper, July 29.
- Noeth, B. J., and R. Sengupta.* 2010. "Flight to Safety and U.S. Treasury Securities." Federal Reserve Bank of St. Louis THE REGIONAL ECONOMIST, July 1.
- Park, W., J. Gouny, and H. Liu.* 2020. "Federal Reserve Agency CMBS Purchases." Federal Reserve Bank of New York LIBERTY STREET ECONOMICS, July 16.
- Schrimpf, A., H. S. Shin, and V. Sushko.* 2020. "Leverage and Margin Spirals in Fixed Income Markets during the COVID-19 Crisis." Bank for International Settlements BIS BULLETIN, no. 2, April 2.
- U.S. Department of the Treasury, Board of Governors of the Federal Reserve System, Federal Reserve Bank of New York, U.S. Securities and Exchange Commission, and U.S. Commodity Futures Trading Commission.* 2015. "The U.S. Treasury Market on October 15, 2014." Joint staff report. July 13.
- Vickery, J., and J. Wright.* 2013. "TBA Trading and Liquidity in the Agency MBS Market." Federal Reserve Bank of New York ECONOMIC POLICY REVIEW 19, no. 1: 1-18.
- Vissing-Jorgensen, A.* 2021. "The Treasury Market in Spring 2020 and the Response of the Federal Reserve." University of California Berkeley working paper, April 5.
- Williams, J. C.* 2020. "A Solution to Every Puzzle: Remarks at the 2020 U.S. Treasury Market Conference." Speech, September 29.

FEDERAL RESERVE BANK OF NEW YORK
ECONOMIC POLICY REVIEW

The Economic Policy Review is published by the Research and Statistics Group of the Federal Reserve Bank of New York. The views expressed are those of the individual authors and do not necessarily reflect the position of the Federal Reserve Bank of New York or the Federal Reserve System.

Series Editor: Julian di Giovanni. *Editorial Staff:* Robert Powell, Trevor Delaney, Maureen Egan, Anna Snider, and Peter Stevens. *Design Staff:* Theresa Izzillo, Alyona Botogoeva, and Laura Gharrity.

Economic Policy Review articles may be reproduced for educational or training purposes, provided they are reprinted in full; include credit to the author(s), the publication, and the Bank; and include the publication's disclaimer.

©2022 The Federal Reserve Bank of New York

www.newyorkfed.org/research
Follow us on Twitter: [@NYFedResearch](https://twitter.com/NYFedResearch)
